

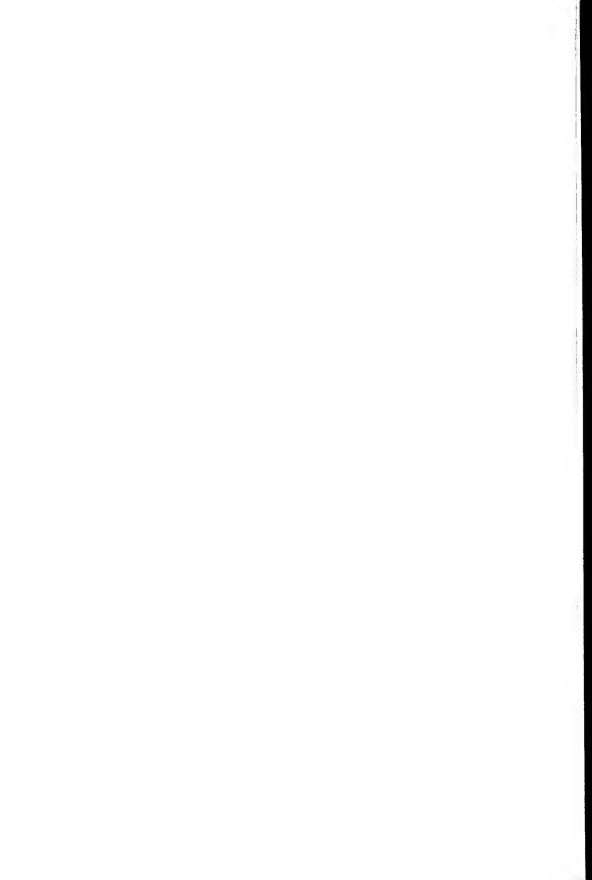

THE ELECTRONIC SWITCHING SYSTEM



The Electronic Switching System



The Electronic Switching System

TRIAL INSTALLATION, MORRIS, ILLINOIS

GENERAL DESCRIPTION



Straley, H. Dean

Switching Systems Development Department

BELL TELEPHONE LABORATORIES, INCORPORATED

WHIPPANY, NEW JERSEY

X-63940

PRIVATE EDITION

Copy No. 294

This book is for the use of Bell System employees only, and no portion thereof shall be reproduced in any form without the written permission of Bell Telephone Laboratories, Incorporated

PRINTED IN THE UNITED STATES OF AMERICA

APRIL 1960

Preface

An electronic switching system employs principles and techniques that are new to telephony. The fundamental objectives are the same as for any dial telephone system, namely, to enable customers to make their calls quickly, accurately, and economically. Achieving these objectives by electronic rather than by electromechanical means, however, involves the use of certain new devices that in many instances replace the familiar relays and other components of previous switching systems.

The electronic switching system (ESS) in Morris, Illinois, is a Laboratories trial installation of the first Bell System all-electronic central office to provide customers with dial telephone service. As with any new system, this trial presents many problems. One of these is the question of how to give maintenance people an understanding of the new concepts introduced.

The ESS can diagnose most of its own troubles and can identify the sources of trouble. But it still needs a maintenance staff well trained in the basic principles of the system. This book constitutes part of the educational material required for training such a staff; it is intended to be used as the text for the ESS plant training courses to be given by the Illinois Bell Telephone Company. The study of this book will prepare the maintenance craftsman for on-the-job training in the new method of simplified maintenance used in the ESS.

This book gives a general description of the ESS, and tells how electronic switching resembles and how it differs from electro-mechanical switching. It describes the apparatus elements used, and shows how they operate individually and together. It explains the respective functions and operations of the major components and of the power equipment. It traces the progress of calls through the system, telling how the customer's dialed instructions are analyzed and carried out. In short, this book presents a perspective of the principles, equipment, and operation of electronic switching.

The material in this book is presented in the order considered most suitable for learning and understanding how ESS works. Chapter 1, *An Introduction to the Morris Electronic Switching System*, gives a broad over-all view of the ESS

installed in Morris. It describes features and arrangements that are common to most of the equipment in the system. Chapter 2, *Method of Operation*, tells how various calls are handled by tracing their progress through the system and describing briefly the functions of the circuit units encountered. The chapters that follow give more details about the operation of separate circuit units, as well as information on power supplies and maintenance. The new technical terms that are introduced and explained in the course of the text are summarized and again defined in the Appendix, which constitutes a glossary.

The electronic switching system was developed through the cooperation of many people whose contributions are recognized elsewhere. Appropriate acknowledgment should also be made to those who prepared this book. Some of the material here is original; the rest was gathered from numerous sources. All of it was compiled under the supervision of George H. Duhnkrack, whose co-authors included Robert E. Eberhardt and Darwin T. Osmonson of the Illinois Bell Telephone Company as well as Francis J. Herron, John N. Mackessy, John V. Pinney, Frederick J. Raile, and Earl R. Williams, all of Bell Telephone Laboratories. The authors are in turn indebted to those anonymous scientists, engineers, and other counselors whose penetrating and constructive comments added to the accuracy of the text.

The typography, printing, and binding were handled by Kenneth M. Collins. The ESS emblem on the title page was based on a design suggested by Sih Hsuin Tsiang. It was selected from many ingenious devices proposed.

It is hoped that the general description of the ESS presented in this book will form the background for a more detailed study of electronic switching. This volume itself is an integral portion of the training program for the Morris trial installation. Your comments on the book will be appreciated and will help in the preparation of training material for electronic switching systems of the future.

CLARENCE A. LOVELL

Director of Switching
Systems Development

Whippany, New Jersey
January 1960

Contents

CHAPTER 1	Page	1
<i>An Introduction to the Morris Electronic Switching System</i>		
FIG. 1-1. Location of the Morris ESS	Page	2
TABLE 1-1. Customer services to be provided in the Morris ESS	Page	2
1.1 THE ESS COMPARED WITH NO. 5 CROSSBAR	Page	3
TABLE 1-2. Features to be provided in the Morris ESS	Page	3
FIG. 1-2. The ESS trunking plan	Page	4
TABLE 1-3. New techniques introduced in the Morris ESS	Page	5
1.2 FUNCTIONS OF THE MAJOR COMPONENTS	Page	5
1.2.1 The Scanner	Page	5
FIG. 1-3. ESS equipment schematic	Page	6
FIG. 1-4. Scanner connections to lines and trunks	Page	7
1.2.2 The Signal Distributor	Page	8
1.2.3 The Barrier Grid Store	Page	8
1.2.4 The Flying Spot Store	Page	9
1.2.5 The Switching Networks	Page	10
FIG. 1-5. Switching network plan	Page	11
1.2.6 The Central Control	Page	12
1.2.7 The Stand-By Transfer	Page	12
1.2.8 The Administration Center	Page	13
TABLE 1-4. Functions of the Administration Center	Page	13
1.2.9 The Announcement System	Page	13
FIG. 1-6. Floor plan for the Morris ESS	Page	14
1.3 EQUIPMENT ARRANGEMENTS	Page	14
1.3.1 Cabinet Design	Page	15
FIG. 1-7. Front view of cabinet line-up	Page	15
FIG. 1-8. Front view of marker and network cabinets	Page	16
1.3.2 Wiring and Local Cabling	Page	17

1.4 APPARATUS ELEMENTS	Page 17
1.4.1 Circuit Packages	Page 18
1.4.2 Connectors	Page 18
1.4.3 Locating Packages	Page 19
FIG. 1-9. <i>Typical circuit packages</i>	Page 19
FIG. 1-10. <i>Circuit package co-ordinate system</i>	Page 20
1.4.4 Electron Tubes	Page 21
FIG. 1-11. <i>Gas diode crosspoint</i>	Page 21
FIG. 1-12. <i>Gas diode module</i>	Page 22
FIG. 1-13. <i>Gas tetrode</i>	Page 23
1.4.5 Inventory of Major Apparatus Elements	Page 23
TABLE 1-5. <i>Inventory of major apparatus elements</i>	Page 24
1.5 POWER EQUIPMENT	Page 24
1.5.1 Motor Alternators—Source of A-C Power	Page 25
FIG. 1-14. <i>Motor-alternator set with d-c and a-c drive motors and fly wheel</i>	Page 25
FIG. 1-15. <i>A-C power plant</i>	Page 26
1.5.2 A-C Distribution for D-C Power Supplies	Page 26
FIG. 1-16. <i>Primary a-c distribution</i>	Page 27
FIG. 1-17. <i>Diesel engine alterator</i>	Page 27
FIG. 1-18. <i>A-C distribution for d-c power supplies</i>	Page 28
FIG. 1-19. <i>48-volt d-c power distribution</i>	Page 28
1.5.3 Tone Power Supplies	Page 29
FIG. 1-20. <i>Connection of audible ringing tone generator to the signal switching network</i>	Page 29
FIG. 1-21. <i>Connection of dial, busy, and re-order tone generator to the tone points in the distribution switching network</i>	Page 29
TABLE 1-6. <i>Tone power supplies</i>	Page 30
FIG. 1-22. <i>Tone ringer power supplies</i>	Page 30
1.5.4 Tone Ringing Power Supplies	Page 31
1.6 STATION SETS	Page 31
FIG. 1-23. <i>Low-current tone ringer telephone set</i>	Page 31
FIG. 1-24. <i>Telephone set, internal view</i>	Page 32
FIG. 1-25. <i>Sound radiator</i>	Page 32
1.7 TESTING AND MAINTENANCE PHILOSOPHY	Page 33

CHAPTER 2

Page 35

Method of Operation

FIG. 2-1. <i>Connections for dial tone and for dialing</i>	Page 36
FIG. 2-2. <i>Connections for an intraoffice call, showing the paths for regular ringing, audible ringing, and talking</i>	Page 37
FIG. 2-3. <i>Connections for a reverting call: ringing and talking paths</i>	Page 38
FIG. 2-4. <i>Talking connection for an operator call or an outgoing call</i>	Page 39
FIG. 2-5. <i>Connections for an incoming call, showing the paths for regular ringing, audible ringing, and talking</i>	Page 40
FIG. 2-6. <i>Skew ringing and talking connections for an intraoffice call or an incoming call</i>	Page 41
2.1 ESTABLISHING THE DIALING CONNECTION—FIG. 2-7	Page 42
FIG. 2-7. <i>Establishing a dialing connection</i>	Page 43
2.1.1 Dial Tone Connection—FIG. 2-7	Page 44
2.1.2 Dialing Connection	Page 45
2.2 INTRAOFFICE CALL—FIG. 2-8	Page 46
FIG. 2-8. <i>Establishing an intraoffice call</i>	Page 46
2.3 REVERTING CALL—FIG. 2-9	Page 48
FIG. 2-9. <i>Establishing a reverting call</i>	Page 49
2.4 OUTGOING CALL—FIG. 2-10	Page 50
FIG. 2-10. <i>Establishing an outgoing call</i>	Page 51
2.5 INCOMING CALL—FIG. 2-11	Page 52
FIG. 2-11. <i>Establishing an incoming call</i>	Page 53
2.6 CALLS TO THE 3CL SWITCHBOARD—FIG. 2-12	Page 55
2.6.1 Recording-Completing (Zero Operator)	Page 55
FIG. 2-12. <i>Establishing calls to the 3CL switchboard</i>	Page 56
2.6.2 Permanent Signals	Page 59
2.6.3 Partial Dial	Page 60
2.6.4 Vacant Codes	Page 60
2.6.5 Denied Service	Page 60

CHAPTER 3	<i>The Switching Networks</i>	Page 61
	FIG. 3-1. <i>A typical 3-by-3 switch and a typical 10-by-10 switch</i>	Page 62
	FIG. 3-2. <i>Four-stage network wiring pattern</i>	Page 63
3.1 THE DISTRIBUTION SWITCHING NETWORK		Page 64
	FIG. 3-3. <i>Distribution switching network, six-stage wiring pattern</i>	Page 64
	FIG. 3-4. <i>Junctor slip wiring pattern: A, Frame 0; B, Frame 1; C, Frame 2</i>	Page 66
	TABLE 3-1. <i>Formula for junctor slip pattern</i>	Page 67
	FIG. 3-5. <i>Distribution switching network, wiring pattern</i>	Page 68
3.2 CONCENTRATION SWITCHING NETWORK		Page 69
	FIG. 3-6. <i>Concentration switching network, 40-by-10 switch</i>	Page 69
3.3 SIGNAL SWITCHING NETWORK		Page 70
3.4 EQUIPMENT ARRANGEMENTS		Page 70
3.4.1 Switching Networks		Page 70
	FIG. 3-7. <i>Switching networks cabinet, front view</i>	Page 71
	FIG. 3-8. <i>Office concentrator line terminal package</i>	Page 72
	FIG. 3-9. <i>Junctor package</i>	Page 73
	TABLE 3-2. <i>Packages used in the switching networks</i>	Page 74
	FIG. 3-10. <i>Crosspoint module</i>	Page 75
	FIG. 3-11. <i>2-by-10 crosspoint module</i>	Page 75
	FIG. 3-12. <i>Switching networks cabinet, front equipment</i>	Page 76
	FIG. 3-13. <i>External wiring to switching networks cabinet</i>	Page 77
	FIG. 3-14. <i>Switching networks cabinet, rear equipment</i>	Page 78
	FIG. 3-15. <i>Switching networks cabinet, rear view</i>	Page 79
	TABLE 3-3. <i>Typical assignment of trunks on the distribution switching network</i>	Page 80
3.4.2 Distributing Frames		Page 81
	FIG. 3-16. <i>Trunk distributor</i>	Page 82
3.5 METHOD OF OPERATION		Page 83
3.5.1 Establishing a Talking and Signaling Path in the Concentration Switching Network		Page 83
	FIG. 3-17. <i>Talking and signaling path through concentration switching network</i>	Page 84

3.5.2	Establishing a Talking and Signaling Path in the Distribution Switching Network	Page 85
	FIG. 3-18. <i>Talking and signaling path through distribution switching network</i>	Page 86
	FIG. 3-19. <i>Ringng trunk connection</i>	Page 88
	FIG. 3-20. <i>Talking connection</i>	Page 88
3.5.3	Establishing a Signaling Path in the Signal Switching Network	Page 89
	FIG. 3-21. <i>Signaling path through ringing switch</i>	Page 90
	FIG. 3-22. <i>Talking path through skew ringing trunk</i>	Page 91
3.6	POWER	Page 92
3.6.1	Power Requirements	Page 92
3.6.2	Power Equipment	Page 92
	FIG. 3-23. <i>Power supplies and their outputs</i>	Page 93
	FIG. 3-24. <i>Voltage divider</i>	Page 94
	FIG. 3-25. <i>Voltage divider assembly</i>	Page 94
	FIG. 3-26. <i>Power cabinets for distribution switching network and distribution markers 0 and 1; front view</i>	Page 95
	FIG. 3-27. <i>Individual power supply, front view</i>	Page 96
	FIG. 3-28. <i>Individual power supply, internal view</i>	Page 96
	FIG. 3-29. <i>Power panel for distribution switching network and distribution markers 0 and 1; front equipment</i>	Page 98
	FIG. 3-30. <i>Power cabinets for concentration network, signal switching network, and concentration markers 0 and 1; front view</i>	Page 99
3.7	MAINTENANCE	Page 100
3.7.1	No-Connection Test	Page 100
3.7.2	Low-Breakdown Test	Page 101
CHAPTER 4		Page 102
<i>Concentration and Distribution Markers</i>		
4.1	INTRODUCTION TO THE CM AND DM OPERATIONS	Page 103
	FIG. 4-1. <i>Marker cabinets, front view</i>	Page 103
4.1.1	Dial Tone Connections	Page 103
4.1.2	The Ringing Connections	Page 105

4.1.3	The Called Customer Answers	Page 105
4.1.4	Disconnect	Page 105
4.2	EQUIPMENT ARRANGEMENTS	Page 106
	FIG. 4-2. <i>Mounting arrangements for the 1½-inch packages</i>	Page 106
4.2.1	Apparatus Elements	Page 106
4.2.2	Apparatus Mounting Arrangements—Figs. 4-2 and 4-3	Page 107
4.2.3	Cabinet Layout of the Concentration Marker	Page 107
	FIG. 4-3. <i>Mounting arrangements for the 7-inch packages, seen from below</i>	Page 108
	FIG. 4-4. <i>Miscellaneous marker apparatus</i>	Page 109
	FIG. 4-5. <i>Concentration marker, front view</i>	Page 110
	FIG. 4-6. <i>Concentration marker, front equipment</i>	Page 111
	FIG. 4-7. <i>Concentration marker, rear equipment</i>	Page 112
4.2.4	Cabinet Layout of the Distribution Marker	Page 113
	FIG. 4-8. <i>Distribution marker, front view</i>	Page 114
	FIG. 4-9. <i>Distribution marker, front equipment</i>	Page 115
	FIG. 4-10. <i>Distribution marker, rear equipment</i>	Page 116
4.2.5	Cabinet Doors and Gates	Page 117
4.2.6	Power Supply Cabinets	Page 117
4.3	METHOD OF OPERATION OF THE CONCENTRATION MARKER	Page 117
4.3.1	Network Orders	Page 117
	TABLE 4-1. <i>Typical switching network orders to the markers</i>	Page 118
4.3.2	Functions of CM Circuits (Fig. 4-11)	Page 119
	TABLE 4-2. <i>Functions of the circuits in the CM</i>	Page 119
4.3.3	Sequence Control, 0 or 1 Marker (Fig. 4-11)	Page 119
	FIG. 4-11. <i>Concentration marker, block diagram</i>	Page 120
4.3.4	Line Selector Control, 0 or 1 Marker (Fig. 4-11)	Page 127
4.3.5	Line Selector, 0 or 1 Marker (Fig. 4-11)	Page 127
4.3.6	Line Selector Verifier, 0 or 1 Marker (Fig. 4-11)	Page 128
4.3.7	Trunk Level Enabler, 0 or 1 Marker (Fig. 4-11)	Page 128
4.3.8	Trunk Level Identifier and Match Detector, 0 or 1 Marker (Fig. 4-11)	Page 129
4.3.9	Trunk Release Selector Control, 0 or 1 Marker (Fig. 4-11)	Page 129
4.3.10	Trunk Release Selector, 0 or 1 Marker (Fig. 4-11)	Page 129

4.4 METHOD OF OPERATION OF THE DISTRIBUTION MARKER	Page 130
4.4.1 Functions of the DM Circuits (Fig. 4-12)	Page 130
4.4.2 Sequence Control, 0 or 1 Marker (Fig. 4-12)	Page 130
TABLE 4-3. <i>Functions of the circuits in the DM</i>	Page 131
FIG. 4-12. <i>Distribution marker, block diagram</i>	Page 132
4.4.3 Trunk Selector Control, A or B Side, 0 or 1 Marker (Fig. 4-12).	Page 138
4.4.4 Trunk Selector, A or B Side, 0 or 1 Marker (Fig. 4-12)	Page 138
4.4.5 Trunk Identifier, A or B Side, 0 or 1 Marker (Fig. 4-12)	Page 139
4.4.6 Propagator Pulser, A or B Side, 0 or 1 Marker (Fig. 4-12)	Page 140
4.4.7 Junctor Enabler, 0 or 1 Marker (Fig. 4-12)	Page 140
4.4.8 Junctor Release Pulser, 0 or 1 Marker (Fig. 4-12)	Page 141
4.5 METHOD OF OPERATION OF MISCELLANEOUS CIRCUITS	Page 142
4.5.1 Marker Transfer Circuit—Distribution Marker	Page 142
4.5.2 Marker Transfer Circuit—Concentration Marker	Page 142
4.5.3 Power Interrupter Circuit—Interlocks—Distribution Marker	Page 142
4.5.4 Power Interrupter Circuit—Interlocks—Concentration Marker	Page 143
4.5.5 Trouble Detectors 0 or 1, Concentration Marker (Fig. 4-13)	Page 143
FIG. 4-13. <i>Concentration marker, block diagram of trouble detector</i>	Page 143
FIG. 4-14. <i>Distribution marker, block diagram of trouble detector</i>	Page 144
4.5.6 Trouble Detectors 0 or 1, Distribution Marker (Fig. 4-14)	Page 145
4.6 MAINTENANCE	Page 145

CHAPTER 5 Page 147

The Scanner

5.1 EQUIPMENT ARRANGEMENTS	Page 147
FIG. 5-1. <i>Scanner, front view.</i>	Page 148
FIG. 5-2. <i>Scanner, rear view</i>	Page 149
FIG. 5-3. <i>Scanner equipment</i>	Page 150
5.2 METHOD OF OPERATION	Page 150
TABLE 5-1. <i>Equipment designations</i>	Page 151
FIG. 5-4. <i>Sequence of scanning modes</i>	Page 152
FIG. 5-5. <i>Scanning cycle</i>	Page 153
FIG. 5-6. <i>Matrix of transmission gates</i>	Page 153
FIG. 5-7. <i>Scanner block diagram</i>	Page 154
FIG. 5-8. <i>Input selector</i>	Page 156

FIG. 5-9. <i>Input translator</i>	Page 157
FIG. 5-10. <i>Operation of gate matrix</i>	Page 158
FIG. 5-11. <i>Output selector</i>	Page 160
FIG. 5-12. <i>Output translator</i>	Page 162
5.3 DUPLICATION AND TRANSFER	Page 162
FIG. 5-13. <i>Circuit identification marking (tracking voltage regulators)</i>	Page 163
FIG. 5-14. <i>Circuit identification marking (transfer units)</i>	Page 163
FIG. 5-15. <i>Circuit identification marking (output amplifiers and transfer)</i>	Page 164
FIG. 5-16. <i>Scanner transfer</i>	Page 165
5.4 POWER	Page 166
FIG. 5-17. <i>Scanner power equipment, SC-0</i>	Page 166
FIG. 5-18. <i>Scanner power equipment, SC-1</i>	Page 167
FIG. 5-19. <i>Power supply, —50 volts</i>	Page 168
TABLE 5-2. <i>Scanner power distribution</i>	Page 169
FIG. 5-20. <i>Power supplies and paralleling units.</i>	Page 170
FIG. 5-21. <i>Relay contact patching</i>	Page 170
5.5 MISCELLANEOUS	Page 171
5.6 MAINTENANCE	Page 171
TABLE 5-3. <i>Packages used in the scanner</i>	Page 172
CHAPTER 6	Page 174
<i>The Stand-By Transfer</i>	
6.1 GENERAL.	Page 174
6.2 EQUIPMENT ARRANGEMENTS	Page 176
FIG. 6-1. <i>ESS transfer paths</i>	Page 176
FIG. 6-2. <i>Stand-by transfer, front view</i>	Page 178
FIG. 6.3. <i>Stand-by transfer, front equipment, Bay 0 and Bay 2</i>	Page 179
FIG. 6-4. <i>Stand-by transfer, rear view</i>	Page 180
FIG. 6-5. <i>Stand-by transfer, rear equipment, Bay 3 and Bay 1</i>	Page 181
TABLE 6-1. <i>Packages used in the stand-by transfer</i>	Page 182
6.3 POWER	Page 182
6.4 MAINTENANCE	Page 183

CHAPTER 7		Page 185
	<i>The Signal Distributor</i>	
7.1 EQUIPMENT ARRANGEMENTS		Page 185
FIG. 7-1. <i>Signal distributor, functional diagram</i>		Page 186
TABLE 7-1. <i>Operations directed by signal distributor outputs</i>		Page 186
FIG. 7-2. <i>Signal distributor, front view and front equipment</i>		Page 187
FIG. 7-3. <i>Signal distributor, rear view and rear equipment</i>		Page 188
TABLE 7-2. <i>Packages used in the signal distributor</i>		Page 189
FIG. 7-4. <i>Signal distributor, block diagram</i>		Page 190
7.2 METHOD OF OPERATION		Page 190
7.2.1 General Description of Operation		Page 190
7.2.2 Selector Drive A or B		Page 191
7.2.3 Matrix (Flip-Flop Groups 00 through 31)		Page 192
FIG. 7-5. <i>Matrix, FF Groups 00 through 31</i>		Page 193
FIG. 7-6. <i>Typical output from a point assigned to an outgoing trunk</i>		Page 194
7.3 DUPLICATION AND TRANSFER		Page 194
FIG. 7-7. <i>Signal distributor, transfer of duplicated equipment</i>		Page 194
7.4 POWER		Page 195
7.5 MISCELLANEOUS		Page 196

CHAPTER 8		Page 198
-----------	--	----------

The Barrier Grid Store

8.1 DESCRIPTION OF THE BARRIER GRID STORE		Page 198
FIG. 8-1. <i>Central control and barrier grid store interconnections</i>		Page 199
8.2 EQUIPMENT ARRANGEMENTS		Page 199
8.2.1 BGS-0, Front Bay (Fig. 8-2)		Page 199
FIG. 8-2. <i>Barrier grid store and power cabinets, front view.</i>		Page 200
FIG. 8-3. <i>Barrier grid store, gate bay</i>		Page 201
8.2.2 BGS-0, Rear Bay (Fig. 8-4)		Page 202
FIG. 8-4. <i>Barrier grid store, rear equipment</i>		Page 202
8.2.3 BGP-0, Front Bay		Page 202
TABLE 8-1. <i>Packages used in each barrier grid store</i>		Page 203

8.3 APPARATUS ELEMENTS	Page 203
8.3.1 The Barrier Grid Tube (BGT)	Page 203
FIG. 8-5. <i>Barrier grid tube</i>	Page 203
FIG. 8-6. <i>Barrier grid tube elements</i>	Page 204
FIG. 8-7. <i>Barrier grid tube and read pre-amplifier</i>	Page 204
8.3.2 The Raster Reference Tube (RRT)	Page 205
FIG. 8-8. <i>Raster reference tube</i>	Page 205
FIG. 8-9. <i>Raster reference tube elements</i>	Page 206
FIG. 8-10. <i>Relation of reference edges in RRT to raster in BGT</i>	Page 206
8.4 METHOD OF OPERATION OF THE BGS	Page 207
FIG. 8-11. <i>Barrier grid storage unit, rear view</i>	Page 207
8.4.1 Address and Beam Positioning	Page 207
FIG. 8-12. <i>Barrier grid store, control circuits</i>	Page 208
FIG. 8-13. <i>Barrier grid store, vertical address and deflection circuits</i>	Page 209
8.4.2 The Sequence Control	Page 209
FIG. 8-14. <i>Barrier grid store, sequence control</i>	Page 210
FIG. 8-15. <i>Barrier grid store, operation cycle</i>	Page 210
8.5 REGISTERS	Page 211
TABLE 8-2. <i>Registers in the barrier grid stores</i>	Page 212
FIG. 8-16. <i>Barrier grid store, register layout LRT-0</i>	Page 214
FIG. 8-17. <i>Barrier grid store, register layout LRT-1</i>	Page 215
FIG. 8-18. <i>Barrier grid store, normal operating mode</i>	Page 216
FIG. 8-19. <i>Barrier grid store, operating modes under various abnormal conditions</i>	Page 217
8.5.1 Register Description	Page 217
TABLE 8-3. <i>Line spot memory assignments</i>	Page 218
TABLE 8-4. <i>System action during supervisory scan of lines</i>	Page 218
TABLE 8-5. <i>Trunk spot memory assignments</i>	Page 219
8.6 POWER	Page 223
8.6.1 Power Control	Page 223
8.6.2 Rectifier Units	Page 224
8.7 MAINTENANCE	Page 224

CHAPTER 9

Page 226

The Flying Spot Store

9.1 THE FSS INFORMATION SYSTEMS	Page 226
FIG. 9-1. <i>Flying spot store information channel</i>	Page 227
9.2 THE SYSTEM PROGRAM	Page 227
FIG. 9-2. <i>Main program sequences</i>	Page 230
FIG. 9-3. <i>Order word structure</i>	Page 234
9.3 EQUIPMENT ARRANGEMENTS	Page 235
9.3.1 Cabinet FSS-0, Front Bays (Fig. 9-4)	Page 235
TABLE 9-1. <i>Order coding</i>	Page 236
TABLE 9-2. <i>Packages used in each FSS</i>	Page 239
FIG. 9-4. <i>Flying spot store, front view</i>	Page 240
9.3.2 Cabinet FSS-0, Rear Bays (Fig. 9-5)	Page 241
FIG. 9-5. <i>Flying spot store, rear view</i>	Page 241
9.3.3 Cabinet FSS-0, Bay 6 (Fig. 9-6)	Page 242
FIG. 9-6. <i>Flying spot store, end view</i>	Page 243
FIG. 9-7. <i>Flying spot store manual control and meter panels</i>	Page 244
9.3.4 Cabinet FSS-0, Bay 0; Manual Control and Meter Panel (Fig. 9-7)	Page 244
9.4 APPARATUS ELEMENTS	Page 245
9.4.1 The Optics System	Page 245
FIG. 9-8. <i>Flying spot store multiple information channels</i>	Page 246
FIG. 9-9. <i>Flying spot store optics system elements</i>	Page 246
FIG. 9-10. <i>Flying spot store CRT and vertical shutter assembly</i>	Page 247
FIG. 9-11. <i>Flying spot store lens and plate assembly</i>	Page 248
FIG. 9-12. <i>Horizontal shutter and code plate assembly</i>	Page 249
FIG. 9-13. <i>Flying spot store photomultiplier assignments</i>	Page 250
9.4.2 The Photomultiplier Tube	Page 251
FIG. 9-14. <i>Photomultiplier tube, schematic diagram</i>	Page 251
9.5 METHOD OF OPERATION	Page 252
9.5.1 Major Functional Units of the FSS (Fig. 9-16)	Page 252
FIG. 9-15. <i>Flying spot store and central control interconnections</i>	Page 252
FIG. 9-16. <i>Flying spot store block diagram</i>	Page 253
9.5.2 Address and Beam-Positioning Circuits (Fig. 9-17)	Page 253
FIG. 9-17. <i>Flying spot store horizontal address and position circuits</i>	Page 254
FIG. 9-18. <i>Flying spot store servo code plates</i>	Page 255
FIG. 9-19. <i>The effect of low light intensity on beam positioning</i>	Page 256
9.5.3 The Sequence Control	Page 257

9.6 POWER	Page 260
9.6.1 Power Controls	Page 260
FIG. 9-20. <i>Flying spot store power bays</i>	Page 261
9.6.2 Rectifier Units (Fig. 9-20)	Page 262
9.7 MAINTENANCE	Page 262
9.7.1 Routine Tests	Page 262
9.7.2 Diagnostic Tests	Page 263
9.7.3 Marginal Tests	Page 263
9.7.4 Demand Tests	Page 264

CHAPTER 10

Page 265

The Central Control

10.1 EQUIPMENT ARRANGEMENTS	Page 265
FIG. 10-1. <i>Central control, front view</i>	Page 266
FIG. 10-2. <i>Central control, rear view</i>	Page 267
FIG. 10-3. <i>Central control equipment, front</i>	Page 268
FIG. 10-4. <i>Central control equipment, rear</i>	Page 268
TABLE 10-1. <i>Abbreviations for equipment functional designations</i>	Page 269
10.2 METHOD OF OPERATION	Page 270
FIG. 10-5. <i>ESS clock timing</i>	Page 271
10.2.1 Circuits Associated with the Flying Spot Store (Fig. 10-7)	Page 271
FIG. 10-6. <i>Central control block diagram</i>	Page 272
FIG. 10-7. <i>Central control circuits associated with the flying spot store</i>	Page 274
FIG. 10-8. <i>ESS clock timing for transfers</i>	Page 275
10.2.2 Decision-Making Circuits (Fig. 10-9)	Page 276
FIG. 10-9. <i>Decision-making elements</i>	Page 276
10.2.3 Parity-Check Circuits and Error-Correction Circuits (Fig. 10-10)	Page 278
FIG. 10-10. <i>Parity-check circuits and error-correction circuits</i>	Page 279
10.2.4 Internal Flip-Flop Groups of the Central Control (Fig. 10-11)	Page 279
FIG. 10-11. <i>Internal flip-flop groups or registers</i>	Page 280
10.2.5 External Unit Registers within the Central Control (Fig. 10-12)	Page 281
FIG. 10-12. <i>External unit registers within the central control</i>	Page 282
10.2.6 Repeat-Order Circuits (Fig. 10-13)	Page 283
FIG. 10-13. <i>Repeat-order circuits</i>	Page 284

10.2.7 Circuits Associated with the Scanner (Fig. 10-14)	Page 284
FIG. 10-14. <i>Circuits associated with the scanner</i>	Page 285
10.2.8 Circuits that Control BGS Operation (Fig. 10-15)	Page 285
FIG. 10-15. <i>Circuits associated with the barrier grid store</i>	Page 286
10.3 POWER	Page 287
10.4 MISCELLANEOUS	Page 288
10.5 MAINTENANCE	Page 290
TABLE 10-2. <i>Packages used in the central controls</i>	Page 292

CHAPTER 11

Page 295

Trunk Circuits

11.1 EQUIPMENT ARRANGEMENTS	Page 295
FIG. 11-1. <i>ESS trunking plan</i>	Page 296
TABLE 11-1. <i>Trunks initially assigned in the Morris ESS</i>	Page 297
11.2 METHOD OF OPERATION	Page 297
FIG. 11-2. <i>Trunk cabinet, rear view and rear equipment</i>	Page 298
FIG. 11-3. <i>Typical transmission path from a customer telephone set to a trunk</i>	Page 299
11.2.1 Operator Call, Recording-Completing Trunk (Fig. 11-4)	Page 299
11.2.2 Trunk Connection to Two Sides of Distribution Switching Network (Fig. 11-5)	Page 299
FIG. 11-4. <i>Incoming or outgoing trunk to the 3CL switchboard, single-sided termination</i>	Page 300
FIG. 11-5. <i>Incoming or outgoing trunk to the 3CL switchboard, double-sided termination</i>	Page 300
11.2.3 No-Test Trunks (Fig. 11-6)	Page 301
FIG. 11-6. <i>Outgoing trunk from the 3CL switchboard arranged for no-test, double-sided termination</i>	Page 301
11.2.4 Two-Way Trunk Circuit for PBX Tie Line (Fig. 11-7)	Page 302
FIG. 11-7. <i>Two-way trunk with E and M lead signaling for PBX tie line, single-sided termination</i>	Page 303
11.2.5 Trunk Circuit to the No. 5 Crossbar Office (Fig. 11-8)	Page 304
FIG. 11-8. <i>Incoming or outgoing trunk to No. 5 crossbar office with E and M lead signaling, single-sided termination</i>	Page 305
11.3 MAINTENANCE	Page 306

CHAPTER 12

The Administration Center

Page 307

12.1 EQUIPMENT ARRANGEMENTS	Page 307
FIG. 12-1. <i>Administration center, front view</i>	Page 308
FIG. 12-2. <i>Typing reperforator and tape</i>	Page 310
FIG. 12-3. <i>Cabinet AC-0, front view, Bay 0</i>	Page 311
FIG. 12-4. <i>Cabinet AC-0, rear view, Bay 1</i>	Page 312
FIG. 12-5. <i>Cabinet AC-0, front view, Bay 2</i>	Page 313
FIG. 12-6. <i>Cabinet AC-0, rear view, Bay 3</i>	Page 314
12.2 METHOD OF OPERATION	Page 315
FIG. 12-7. <i>Administration center display panel and associated equipment</i>	Page 316
12.3 MAINTENANCE	Page 318

CHAPTER 13

The Ringing and Tone Supply

Page 320

13.1 EQUIPMENT ARRANGEMENTS	Page 320
13.2 METHOD OF OPERATION	Page 320
FIG. 13-1. <i>Ringing and tone supply cabinet, front view of front bay (gate)</i>	Page 322
FIG. 13-2. <i>Ringing and tone supply cabinet, rear views of front bay (gate) and rear bay</i>	Page 324
FIG. 13-3. <i>Ringing tone supply, block diagram</i>	Page 325
FIG. 13-4. <i>Tone supply, block diagram</i>	Page 326
FIG. 13-5. <i>Interruption timing supply, block diagram</i>	Page 327
13.3 DUPLICATION AND TRANSFER	Page 328
13.4 POWER	Page 328
13.5 MAINTENANCE	Page 329

CHAPTER 14

Power Distribution

Page 330

14.1 EQUIPMENT ARRANGEMENTS	Page 330
14.2 METHOD OF OPERATION	Page 331

14.2.1 A-C Power Distribution—Figs. 14-1, 14-3	Page 331
14.2.2 D-C Power Distribution—Figs. 14-1, 14-3	Page 331
FIG. 14-1. <i>Power distribution cabinet, front view</i>	Page 332
FIG. 14-2. <i>Power distribution cabinet, rear view</i>	Page 333
FIG. 14-3. <i>A-C and D-C power distribution</i>	Page 334
CHAPTER 15	Page 335
<i>The Alarm System</i>	
FIG. 15-1. <i>Floor layout of alarm systems and alarm zones</i>	Page 336
FIG. 15-2. <i>Trouble-indicating lamps and control keys at the administration center</i>	Page 337
CHAPTER 16	Page 342
<i>Customer Group Service and Bridged Extension Service</i>	
16.1 UNATTENDED CGS	Page 342
16.1.1 Method of Operation	Page 342
16.2 ATTENDED CGS	Page 343
TABLE 16-1. <i>Indications received on "add-on" calls</i>	Page 344
TABLE 16-2. <i>Visible and audible signals to the CGS attendant</i>	Page 344
16.2.1 Equipment Arrangements	Page 345
16.2.2 Method of Operation	Page 345
TABLE 16-3. <i>Codes dialed by the CGS attendant</i>	Page 346
FIG. 16-1. <i>Attended CGS, block diagram</i>	Page 347
FIG. 16-2. <i>Attendant's telephone set</i>	Page 348
16.2.3 Maintenance	Page 348
FIG. 16-3. <i>Announcement system</i>	Page 349
FIG. 16-4. <i>Lamp control unit and power unit</i>	Page 350
TABLE 16-4. <i>Ringng codes for bridged extension service</i>	Page 350
16.3 BRIDGED EXTENSION SERVICE	Page 351
APPENDIX	Page 352
<i>Glossary of ESS Technical Terms</i>	

The Electronic Switching System

Chapter 1

An Introduction to the Morris Electronic Switching System

The first Bell System all-electronic central office to provide customers with dial telephone service has been installed to serve as part of the WHITNEY 2 exchange in Morris, Illinois. It is a trial installation, furnishing service initially to certain individual and group service business stations as well as individual, two-party, and eight-party residential lines.

Morris is about 65 miles southwest of Chicago, as shown on Fig. 1-1. It was chosen for the trial of the first electronic switching system (ESS) because it is an isolated local central office that is nevertheless large enough to try out the high-speed control and nonmetallic switching network features of the ESS. Also, there is no apparent need of developing, at this time, all the service features required for a larger office.

The Illinois Bell Telephone Company decided to replace the manual system in Morris by a No. 5 crossbar system in 1959. The crossbar system, which will be in operation before the ESS is installed, will handle all the traffic in Morris before and after the ESS trial. During the trial, some six hundred customer lines will be transferred to the ESS. A summary of these lines, with the services to be provided, is given in Table 1-1. The ESS is designed to handle most of the kinds of customer services currently furnished in Morris.

The features provided in the Morris ESS were dictated by the telephone needs of the community and by the characteristics of the electronic switching system. Those features are summarized in Table 1-2.

All traffic to and from the ESS in Morris will be carried over trunks connecting with either the Morris 3CL switchboard or the Morris No. 5 crossbar system. The trunking plan is shown in Fig. 1-2, on page 4. The trunk numbering plan is described in Chapter 3 of this book, *Switching Networks*. Miscellaneous service trunks and trunk groups are discussed in Chapter 11, *Trunks*.

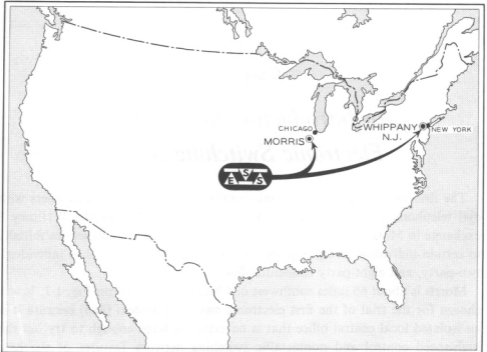

FIG. 1-1. Location of the Morris ESS.

VG 101

TABLE 1-1. CUSTOMER SERVICES TO BE PROVIDED
IN THE MORRIS ESS

Services	Lines	Main Stations
Customer Group Service (CGS) <i>PBX, Key Systems, and Wiring Plans</i>	370	370
Individual Service, Business	50	50
Individual Service, Residential	159	159
Two-Party Service, Residential	64	115
Eight-Party Service, Residential	12	86
TOTALS	655	780

VG 102

1.1 THE ESS COMPARED WITH NO. 5 CROSSBAR

Like the No. 5 crossbar system, the electronic switching system (ESS) is based on the concept of common control. The No. 5 crossbar, however, uses mainly electromechanical devices and several common-control circuits; while the ESS uses chiefly new electronic and solid-state devices, with only one common-control circuit.

Both systems are in a sense special-purpose computers*: their special purpose is the switching of telephone calls between customers. The main difference between the two systems is in the method by which they are controlled. The No. 5 crossbar uses wired relay logic, while the ESS uses stored photographic logic. In other words, the crossbar system operates according to the way its relays are wired, but the ESS operates according to written instructions stored on photographic plates. A change in the written instructions will change the machine operation without any change in wiring.

The chief advantages the ESS has over other switching systems are its high speed of operation, its need for very few moving parts, and its longer trouble-free operating life. Less equipment is required, which also means less building

TABLE 1-2. FEATURES TO BE PROVIDED IN THE MORRIS ESS

1. A new-type low-current telephone set equipped with a tone ringer and a 20-pps dial (20 pulses per second).	8. Outward dial pulsing to step-by-step satellite offices via No. 5 crossbar.
2. A two-five numbering plan.	9. Automatic measuring of traffic.
3. Seven-digit customer dialing of flat-rate local calls and extended area calls.	10. Automatic testing, trouble locating, and trouble recording.
4. Full selective party ringing.	11. Administration controlled by teletypewriter.
5. Operator handling of inward and outward calls.	12. Customer Group Services (CGS) for both PBX and wiring plan customers.
6. In and out dialing by operators.	13. Combined switchboard for DSA and toll calls (Dial 0, inward calls and outward calls).
7. Automatic completion of calls from the Chicago Toll Center via No. 5 crossbar.	14. Reverting calls.
	15. Special services code (0, XII).
	16. Service observing (manual).

VG 103

*Computers are machines capable of performing sequences of internally-stored instructions.

space. We expect that these and other advantages will make it possible in the future to give better service to our customers at lower cost.

The ESS uses only a single central control because it performs repetitive operations at very high speeds—many times faster than is possible with electro-mechanical devices, which are in turn faster than human abilities. In a manual system, several operators are required to handle a number of calls at one time. The ESS operation, however, is so rapid that it can take care of all calls one at a time without perceptible delay. At any instant, one and only one central control operation is taking place in the ESS; but each operation is carried out at a speed that is many times faster than any previous method can achieve.

The high speed of operation of the ESS is attained by the use of a number of new devices and techniques. These are summarized in Table 1-3.

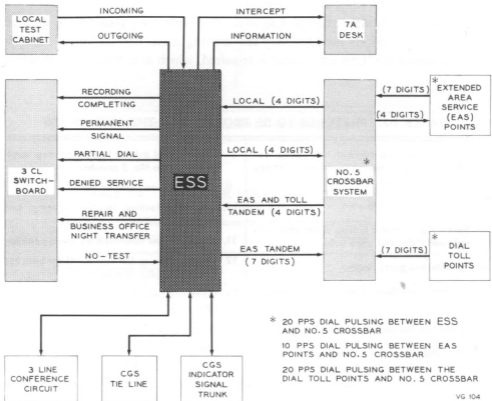

FIG. 1-2. The ESS trunking plan.

TABLE 1-3. NEW TECHNIQUES INTRODUCED IN THE MORRIS ESS

- | |
|--|
| 1. The use of electronic devices and photographic memory instead of electromagnetic elements. |
| 2. Continuous scanning of all supervision and pulsing. |
| 3. The use of serial operation instead of parallel operation. |
| 4. Time-sharing of a single central control. |
| 5. The use of a common electronic switching unit for supervisory switching functions formerly performed in each trunk circuit. |
| 6. Simplified maintenance through the use of plug-in units in the major portion of the equipment. |
| 7. Automatic diagnosis of troubles, and automatic prediction of possible sources of trouble. |

VG 105

1 . 2 FUNCTIONS OF THE MAJOR COMPONENTS

The major components of the ESS are shown schematically in Fig. 1-3. Their functions are described briefly in this section; following chapters explain their operation in more detail. The drawing numbers of the components and the connecting circuits are shown on Key Sheet ES-1A000-01. The terminology used in this book is summarized in the Appendix, which constitutes a glossary of technical terms applying to the electronic switching system.

1 . 2 . 1 *The Scanner*

If you think of the ESS as a robot operator, then the scanner is its "eyes and ears." With a human operator, her eyes and ears detect information on switchboard lines and trunks. This it passes on to her brain. So with ESS the scanner detects the voltage condition of lines and trunks. This it passes on to the central control—the robot's "brain."

The central control must be able to detect the condition at any time of any line (or trunk) in the office. To do this, periodically and at high speeds, the

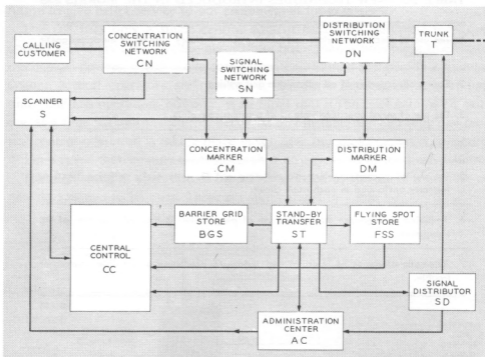
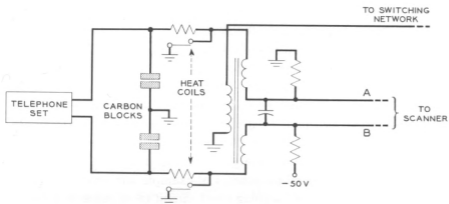

FIG. 1-3. ESS equipment schematic.

VG 106

scanner “looks” at each line. By information from the scanner, and that stored in other parts of the system, the central control can determine that a customer has begun to originate a call, that a call is in progress, or that the call has been disconnected. The scanner checks the voltage of each line ten times a second—that is, every 100 milliseconds. When a request for service is detected, the scanner is further directed to the line every 10 milliseconds (100 times a second). This is necessary in order to recognize changes in line voltage resulting from dial pulses (the dials used in Morris operate at 20 pulses per second, or 20 pps). After the connection has been set up to the called customer and no more dial pulsing is expected, the 10-millisecond scan is stopped. The scanner detects an answer by the called line in the regular 100-millisecond scan. When it does, the ringing of the called line is stopped by the release of the connection from the ringing switch.

Leads from the scanner are connected to two resistors in the loop circuit of each ESS line, as indicated in Fig. 1-4. When a customer originates a call, the closing of the switch hook causes current to flow in the line loop. The current passes through these resistors, where a d-c voltage drop is developed. The voltage disappears whenever the line current is interrupted. This happens during dial pulsing, and again at the end of a call when the switch hook opens the line. The scanner input circuit detects the presence or absence of this voltage, and passes this information to the central control. This gives the central



SCANNER CONNECTION TO A CUSTOMER LINE

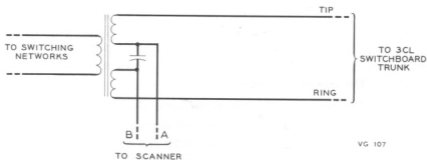

SCANNER CONNECTION TO A TRUNK

FIG. 1-4. Scanner connections to lines and trunks.

control the supervisory information it needs to process the call. The scanner input circuit likewise detects the presence or absence of a signal voltage on a trunk.

1.2.2 The Signal Distributor

The signal distributor can be compared to the “hands” of a telephone operator. The operator inserts the plug of a cord circuit into the switchboard jack of a trunk, and then dials to complete the connection. Likewise, the signal distributor, which acts as the “hands” of a robot operator, connects to a trunk and generates the dial pulses of the called number.

The signal distributor’s job is opposite to that of the scanner. The scanner *gathers* information for the central control; the signal distributor *distributes* information it obtains from the central control.

The signal distributor (SD) consists of a large number of flip-flops (two-state electronic circuits). These are either set (operated) or reset (released) by directions from the central control. The SD is used to distribute signals to one of a number of circuits, such as trunk circuits. To these slow-speed circuits it sends signals from the high-speed central control. The high-speed signals from the central control are received and translated in the signal distributor. From here they are retransmitted at a speed slow enough to operate relays or other devices used on trunks for signal control purposes. For example, the signal distributor is used to operate a relay in an outgoing trunk circuit to outpulse to a distant office.

The signal distributor, among other functions, generates dial pulses on a trunk circuit for transmission to other switching systems. In generating these pulses, the signal distributor receives instructions from the central control at the dial pulse rate. These instructions tell the signal distributor to open or close the trunk loop, or to start or stop a particular pulse. This function of the signal distributor is similar to that of a crossbar sender.

1.2.3 The Barrier Grid Store

The barrier grid store (BGS) is the short-term or temporary erasable memory* of the ESS. It is used to record the status of each call as it progresses through the system. This is the unit that, among other functions, remembers the number dialed by the calling customer. It can be compared to a slate or

*A memory is a medium for retaining information.

scratch pad on which notes are jotted down for future reference. After the notes have been used, the note is erased.

The major component of the barrier grid store is the barrier grid tube (BGT), which is an electrostatic storage tube. This tube is built somewhat like a television tube with an electron gun at one end and a target at the other. The electron gun generates and shoots a pencil-like beam of electrons toward the target. The principal difference between the barrier grid tube and the TV tube is in the target. The target of the TV tube is a phosphor screen of various sizes up to 30 inches in diameter; the target of the barrier grid tube is a piece of mica about 2 inches in diameter.

This "screen" or target area is divided into smaller areas or "spots"; at each of these spots or memory cells it is possible to store an electrical charge. Thus, each spot can record one bit of information.* There are four BGS's in Morris, and each tube (BGT) has a capacity of 16,384 separate bits. Groups of spots in the BGT record information about each call as it progresses through the system. These groups of spots are known as "registers." They work a lot like the relay registers in the No. 5 crossbar system. Some of these spots in the register take the place of certain relays in the trunk circuits of existing systems. For this reason, the trunk circuits in the ESS are relatively simple.

1 . 2 . 4 *The Flying Spot Store*

The flying spot store (FSS) is the second memory component in the system. It is the long-term or semipermanent memory of the ESS. In this memory is stored the entire office service program, the office test program, and the translation data necessary to convert a directory number to an equipment location, to give the type of ringing, etc.

In comparison, a manual telephone system has part of the above information stored in the operator's memory and part in written records. The records provide the reference material that supplements the operator's memory.

In the No. 5 crossbar switching system, the office program is stored in the wiring of the marker, and the translation functions are handled by the number group.

*The term "bit of information" is taken from the language of computer designers. A "bit" is a unit in a binary numbering system; it is always a single digit, either "0" or "1". A bit may be indicated by one of two possible conditions. For example, a bit may be represented by an electrical charge or no electrical charge at a specified position on an electrostatic plate; or by an opaque or a transparent spot on a photographic plate.

The operation of a manual system depends on human memory and reasoning power. In present-day automatic switching systems, the memory and reasoning are "wired-in" and the action is performed by electromechanical devices.

In place of this "human" and "wired-in" memory, the memory media of the ESS are photographic plates; the coded information placed on the plates is called the "stored program." It appears as an array of transparent and opaque areas on the photographic plate. There are two flying spot stores provided in Morris; each one contains about $2\frac{1}{4}$ million storage spots. From the analogy with the manual and the No. 5 crossbar systems, an important difference in the ESS is evident. In the manual system, the records can be changed. In the No. 5 crossbar system, wiring can be altered to make changes. But in the ESS, new photographic plates are prepared and inserted in the FSS.

The FSS focuses a spot of light from the face of a cathode-ray tube on the plates through a system of lenses. The light from one spot on the screen of the cathode-ray tube is imaged simultaneously on several photographic plates. From these it is imaged on a corresponding number of photo-multiplier tubes*. The output from each photo-multiplier tube makes up one bit of information. Consequently, a parallel set of bits is read out of the plates simultaneously for each location on the face of the cathode-ray tube. The sets of bits read out of the plates are relayed to the central control for use as needed.

1.2.5 The Switching Networks

The unit in the ESS that provides the connections among customer lines (and trunks) is called the switching network. There are marked similarities between this network and the No. 5 crossbar switching network. The talking paths through both systems networks are connected by means of *cross-points* and several stages of switching. However, the ESS network uses gas tube cross-points instead of metallic, and a *single-wire* talking path in place of the conventional two-wire circuit.

The ESS switching network consists of the concentration, distribution, and signal switching networks. The controls for the networks are in the concentration and distribution markers, as shown on Fig. 1-3. On command, they can set up or take down connections between trunks or between lines and trunks.

*Photo-multiplier tubes are light-sensing tubes in which the initial photoemission current is multiplied many times, before being extracted at the anode.

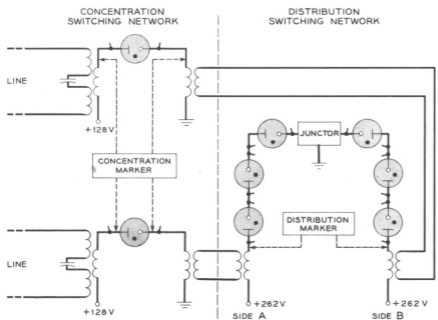
FIG. 1-5. *Switching network plan.*

In the ESS, the switching network operates under the direction of the central control. However, the choice of call paths through the network is selected by the network itself. The markers apply the voltage to the proper network terminals to operate the crosspoints.

Only one side of a talking or ringing connection is switched in the switching networks. The other side uses a common-ground return path (see Fig. 1-5). This simplifies switching, and halves the number of crosspoints used in a connection. But transformers must be used to match the two-wire lines and trunks to the single-wire circuits in the sections of the switching networks.

The matching transformers prevent the use of twenty-cycle ringing through the networks. This means that the ringing signal used in the No. 5 crossbar system won't work in the ESS. Therefore, a new telephone ringing arrangement using a tone ringer instead of a bell is used in the ESS. Instead of the usual twenty-cycle ringing, a tone signal is sent through the switching network over the line to call a customer. The ringing tone is applied through a concentrator-like network called the signal switching network. This network (Fig. 1-3) is

controlled by the concentration marker. Two connections are set up through the switching network whenever a line is being rung. One of these is for sending tone ringing to the called customer; the other is for sending audible ringing tone to the calling customer.

1.2.6 *The Central Control*

The central control (CC) is the "brains" of the ESS. It makes all decisions that control the flow of orders to the various parts of the system. The Morris ESS has two central controls. One is in active service, while the other is serving as a monitor or check ready to take over at any time.

Upon orders from the flying spot store, the central control directs the operation of the barrier grid store, scanner, distribution marker, concentration marker, signal distributor, and flying spot store. For example, the central control directs the scanner in inspecting the present condition of a line. By comparing this condition with the last recorded condition in the BGS, the central control knows whether or not a change has taken place; it can now decide what to do next. On the basis of such decisions, different "program addresses,"* are sent to the FSS. This is the place where instructions are received so that appropriate changes are made in the system.

1.2.7 *The Stand-By Transfer*

Certain critical equipment components in the ESS are duplicated to insure trouble-free telephone service. When one unit of such equipment is in use, a duplicate unit is in reserve or stand-by condition. If a failure occurs in the working or active equipment, that equipment is immediately taken out of service, and the stand-by equipment is substituted. Part of this transfer operation is performed by the stand-by transfer circuit.

The stand-by transfer (ST) circuit includes the equipment for the switching, matching, and marginal voltage test functions of the central control. It also includes miscellaneous apparatus for CC, such as the master clock and the FSS control circuit. The major functions of the stand-by transfer (ST) are the switching functions. These control the transfer of the regular and stand-by equipment on orders from the central control. This transfer takes place between the central control and the following components:

*A program address is a set of characters that identify a register, location, or device in which information is stored.

Flying Spot Store (FSS)

Barrier Grid Store (BGS)

Signal Distributor (SD)

Administration Center (AC)

Distribution Marker (DM)

Concentration Marker (CM)

Ringing and Tone Supply (RT)

6-28-62
 5/10

1.2.8 The Administration Center

The administration center (AC) is used to extract information describing the performance of the office, and to control certain aspects of its operation. It includes the manual controls for the system, a maintenance and traffic recorder, and certain automatic test equipment. The broad functions of the administration center are shown in Table 1-4.

The maintenance information gathered by the ESS is typed out on a teletypewriter controlled by the system. After the system analyzes the trouble, the teletypewriter prints the result in a code. This code is interpreted with the aid of a maintenance manual, or "dictionary," which points out the location and number type of the packages involved. The teletypewriter also records traffic data. In addition it is used to send input signals to the ESS to request test or translation information from the system. For example, to take a unit out of service for maintenance or repair, the order requesting this action is fed into the system by typing it on the teletypewriter.

Two teletypewriter machines are provided. One is used to monitor the systems operation; the other is used for recording data for traffic studies. If one of the machines becomes inoperative, the second machine will carry on the normal functions of both machines.

1.2.9 The Announcement System

The information that indicates call conditions to the PBX attendant can be in the form of voice announcements or lamp signals. Both methods will be tried in Morris to determine customer preference. Since the announce-

TABLE 1-4. FUNCTIONS OF THE ADMINISTRATION CENTER

- | |
|--|
| 1. Programming of routines for automatic trouble location. |
| 2. Trouble recording. |
| 3. Manual control of office functions. |
| 4. Recording of traffic data. |
| 5. Preparation of FSS photographic plates. |

VG 109

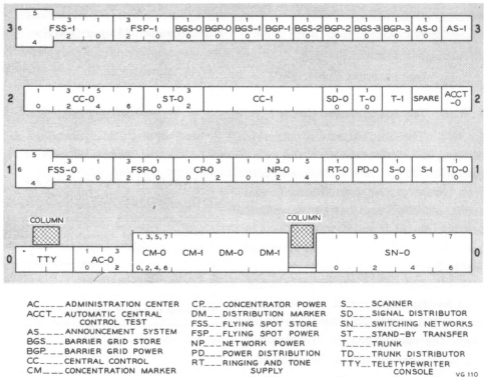

FIG. 1-6. Floor plan for the Morris ESS.

ment system is used on attended customer group services, it will be explained more fully in Chapter 16.

1.3 EQUIPMENT ARRANGEMENTS

The location of the ESS cabinets in the Morris central office is shown in Fig. 1-6. The cabinets are placed to simplify the cabling between them. Thus the power cabinets are placed adjacent to their associated equipment cabinets wherever possible. Also, cabinets that are closely related in operation are placed together. For example, the cabinet containing the concentration and distribution markers is located adjacent to the cabinet containing the switching networks. The administration center and the switching networks are located in a central spot so that you can get to them easily. The cabinets are placed in rows with a 3 foot 6 inch aisle between them.

1.3.1 Cabinet Design

The ESS uses new types of cabinets and new arrangements for mounting equipment. These are quite different from any used in previous telephone switching systems.

The cabinets shown in Fig. 1-7 are the smaller of the two types used. They are made of steel and aluminum, and have an attractive blue-and-gray vinyl finish. Each cabinet is 7 feet high, 2 feet deep, and 28 inches wide. This permits the use of standard 23-inch mounting plates.

These cabinets have magnetically latched aluminum hinged doors on the front and rear. The equipment is mounted in both the front and rear to reduce floor space and to shorten leads between large numbers of packages. Local cabinet wiring is in the center. You get to the equipment wiring by swinging open hinged bays. The equipment in the front of the cabinets is mounted on these bays. The 230-volt a-c power leads and the various d-c and pulse leads

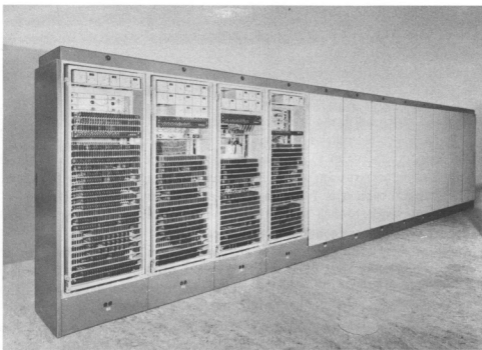

FIG. 1-7. Front view of cabinet line-up.

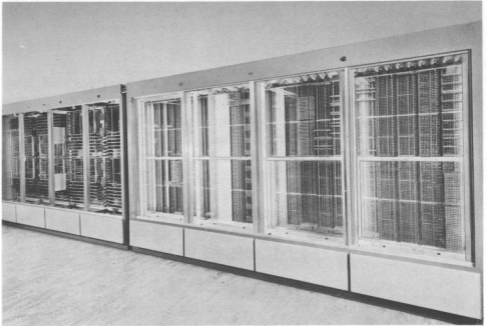

FIG. 1-8. *Front view of marker and network cabinets.*

VG 112

are carried overhead in the tops of the cabinets. The 110-volt a-c power leads for the appliance receptacles are carried in the ducts in the cabinet base.

The cabinets shown in Fig. 1-8 are the larger of the two types used. These have the same construction and finish as the smaller cabinets; only the size is different. Each cabinet is 7 feet high, 3 feet deep, and 12 feet wide, and is arranged for both 16-inch and 31-inch mounting plates. The markers and switching networks are contained in these cabinets.

These cabinets are equipped with aluminum doors hinged on the rear of the cabinets. Sliding glass doors are used on the front of the cabinet housing the switching network equipment. Vinyl finished aluminum sliding doors are used on the front of the cabinet housing the marker equipment. Both cabinets are equipped with fluorescent lighting in the front bays. This is required for the proper functioning of the gas diode elements. As in the smaller cabinets, the equipment is mounted on both front and rear to reduce lead lengths and

floor space. Hinged bays are provided only on the rear of the cabinets containing the markers.

Overhead ducts carry the wiring across the aisles. For the benefit of temperature-sensitive electronic equipment, conditioned air is blown upward from the base of the cabinets. It passes the circuit packages in the front and rear, and goes out into the room through grilles in the top. Separate adjustable grilles near the base in both front and rear of each cabinet direct the air from a common supply. The amount of air is regulated according to the amount of heat to be dissipated in each area.

The front and rear of each cabinet is stamped with its unit abbreviation and number designation. These cabinet designations are listed in Fig. 1-3. In addition, bay numbers are stamped on the front and rear; the even numbers are on the front bays and the odd numbers are on the rear bays. Each cabinet has apparatus designation charts mounted on the inside of the doors to help you identify and locate the equipment. Since the larger 12-foot cabinets have sliding doors on the front, the apparatus designation charts are kept in a book located on the side of each cabinet. A copy of all charts is available at the administration center.

Some of the cabinets have duplicate equipment. This is identified by color coding.

1 . 3 . 2 *Wiring and Local Cabling*

Surface wiring is used throughout all cabinets. Local cable is also required, however, particularly to connect equipment on the swinging bays with the stationary parts of the cabinets. The local cables contain single conductors of various gauge sizes, small-diameter coaxial cable, and twisted pairs. Solderless wrapped connections and small-gauge surface wiring allow an orderly arrangement of wiring.

1 . 4 APPARATUS ELEMENTS

Many of the apparatus elements in the ESS are solid-state semiconductor devices, such as diodes and transistors. A large number of gas diodes and electron tubes are also used. These, along with resistors, capacitors, and transformers, make up the bulk of the circuitry in the ESS. Most of the apparatus is mounted on plug-in wiring boards called circuit packages.

1.4.1 *Circuit Packages*

The smaller components of the circuits used in the ESS are mounted on circuit packages. Three varieties of such packages are shown in Fig. 1-9.

Package (a) is a narrow phenol fiber board, 1.6 inches wide by 7 inches long, which is used with small functional circuits. On this type of board are mounted the small components, with one or two transistors mounted in holes near the outer end. Leads from these transistors are attached to printed conductors that run directly to the end of the board. These conductors are connected with the rest of the circuit pattern through a special shorting connector. This interconnects the conductors on both sides of the board. When you remove this connector, the transistor is isolated, so that you can make electrical checks without removing the transistor from the board. This type of narrow package is an amplifier, used in the central control, scanner, and signal distributor, and to a lesser extent in other cabinets. About 70 per cent of the packages are of this type. These packages are mounted in connectors having code teeth. This permits only packages with coded slots to be inserted.

Package (b) is larger, 3.6 inches by 9 inches. This type of package is used in electron-tube circuits. As many as 66 components may be mounted on one of these boards. This package needs two connectors of the type used with the smaller package. As with the smaller package, the contact end is slot coded, so that you cannot insert the package into the wrong connector. The circuit in this package is a flip-flop* used in the storage systems. Such a package is representative of most packages in the barrier grid store and the flying spot store.

Package (c) varies in size up to 3.3 inches by 10 inches. It is used for mounting more and larger components in a given mounting space. The board mounts up to 14 terminals. These mate with wires strung between molded supports. The wires are gold plated and the terminals are palladium coated to assure low resistance and noise-free contacts. The circuit in this kind of package is a junctor† circuit. It is the type of package most commonly used in the switching network.

1.4.2 *Connectors*

With the exception of the 14-terminal package mentioned above, the packages plug into connectors of a special design. These connectors have 12

*A flip-flop is a device capable of assuming one of two stable states and storing a bit of information. A relay or knife switch does a similar job.

†A junctor is a circuit between the two central stages of the switching network.

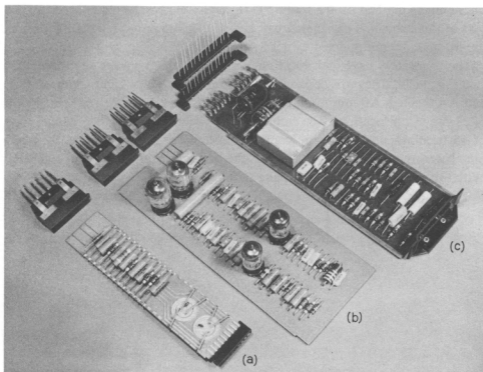
FIG. 1-9. *Typical circuit packages.*

VG 113

terminals each. They are used singly for the narrow packages and in pairs for the wider packages. The spring contacts and mating conductors are gold plated. This assures low contact resistance. To avoid errors in replacing packages, the connectors contain code teeth. Thus, only those packages that have code slots in the corresponding positions can be inserted.

1 . 4 . 3 *Locating Packages*

An important advantage of the connector and package design philosophy is that you can readily locate individual connectors or packages. This is because they are mounted on a co-ordinate basis, as illustrated in Fig. 1-10.

The location of a mounting plate in a cabinet is indicated by a three-digit number. The first digit is the number of the bay, and the other two digits show the location of the mounting plate in that bay. For example, if the front of a cabinet is designated bay 0, the mounting plates on it are prefixed by a 0, and

the numbers marked on the frame (00 through 31) give the plate location. The rear of this cabinet is designated bay 1, and all of its mounting plate locations (00 through 32) are prefixed by a 1.

The connectors have their locations stamped on the package supporting bar (see Fig. 1-10). They are designated by letter from left to right, A through Y and AA through AF, omitting the letters I, O, S, and Z. This gives a maximum of 28 connector locations. The connector has twelve terminals, two vertical rows of six terminals each, for wire wrapping. Looking at the wiring side, these terminals are numbered 1 through 6 from the bottom up, and left (L) or right (R). With this method of designation, any terminal in the cabinet may be identified. For example, the designation 120-AF 6L indicates the following:

1	20	AF	6L
Bay Location	Mounting Plate Location	Connector Location	Connector Terminal

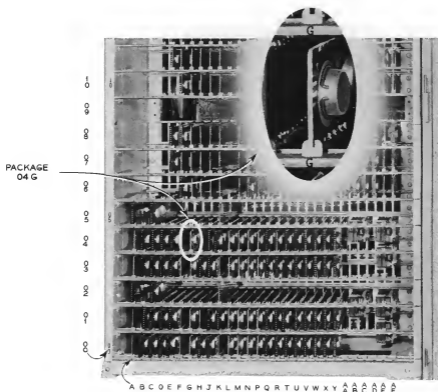

FIG. 1-10. Circuit package co-ordinate system.

1 . 4 . 4 Electron Tubes

Both vacuum and gas-filled electron tubes are used in the ESS. Gas tubes are used to a greater extent than vacuum tubes. The vacuum tubes used in the BGS and the FSS are quite complex in their construction. They are described in the chapters covering these stores. The use of gas tubes in the ESS is described below.

Gas tubes are used mainly in the switching networks. They are used in the following manners:

- (1) As crosspoint elements in the main distribution network and line concentrator units.
- (2) In the selector to set up and release the talking connections.
- (3) In the propagator to maintain the switching margins.
- (4) In the junctor units at the center of the main distribution network.

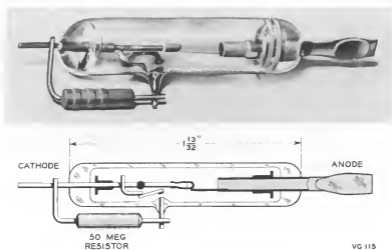

FIG. 1-11. Gas diode crosspoint element.

Gas Diode Crosspoint Elements

The transmission path through the switching network has no metallic contacting elements like those in crossbar switches. Instead, each crosspoint is a two-element gas tube or gas diode; the construction is illustrated in Fig. 1-11. In these tubes the gas breaks down when sufficient voltage is applied across

the electrodes. An electrical path is set up through this gaseous discharge. The speech current and the control signals for the connection are transmitted over this path. The diode has small amplification properties at talking frequencies. This makes up for transmission losses elsewhere in the switching network.

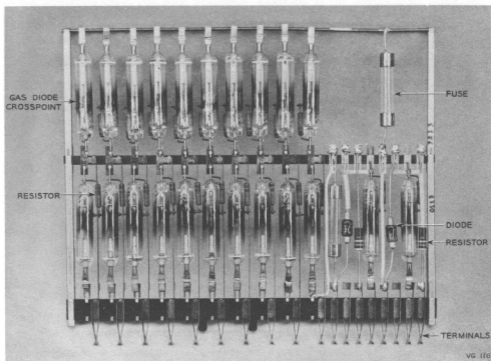

FIG. 1-12. Gas diode module.

Gas Diode Switch Modules

The gas diode crosspoint elements described above are assembled into plug-in packages or modules; a typical module is shown in Fig. 1-12. These packages range up to 5.5 inches by 6.5 inches in size. They contain terminals that mate with wires strung between molded supports, in a manner similar to that for package (c) described in subsection 1.4.1. One module constitutes a 2-by-10 switch; five of these switches are assembled to form a 10-by-10 switch.

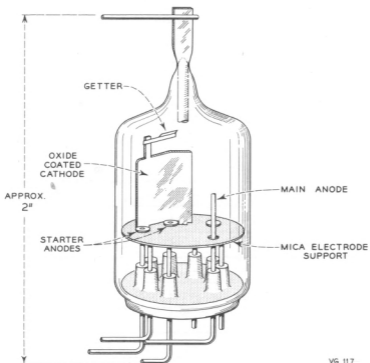

FIG. 1-13. Gas tetrode.

VG 117

Gas Tetrode

The gas tetrode is constructed as shown in Fig. 1-13. It is used in the junctor units at the center of the distribution switching network. The tube has three anodes. A pulse on both starter anodes and the main anode puts the junctor in the talking path. Pulses received by the starter electrodes from either side of the network release the junctor. This in turn disconnects the talking path.

1 . 4 . 5 Inventory of Major Apparatus Elements

The quantities of apparatus elements used in the ESS are shown in Table 1-5 (on page 24). This table shows the approximate number of major apparatus elements used in each of the ESS cabinets.

TABLE 1-5. INVENTORY OF MAJOR APPARATUS ELEMENTS

The quantities given in this table are approximate, and do not include spare apparatus.

Cabinet	Circuit Package	Gas Diode Cross-points	Gas Tube Modules	Vacuum Tubes	Relays	Transistors	Silicon Junction Diodes	Other Diodes
Switching Network	3,600	60,000	3,000	—	—	—	30,000	—
Märkers	6,883	—	—	—	49	2,234	—	4,280
Scanner	1,504	—	—	—	37	964	—	3,828
Signal Distributor	1,162	—	—	—	14	1,804	—	5,754
Central Controls	6,880	—	—	6	—	5,914	200	40,606
Standby Transfer	879	—	—	—	142	598	—	4,938
Barrier Grid Stores	180	—	—	576	—	36	—	13,890
Flying Spot Stores	220	—	—	522	19	—	—	
Trunks	75	—	—	—	185	107	—	195
Administration Center	94	—	—	—	135	86	—	375
FSS Plate Preparation	332	—	—	—	8	293	—	2,120
TOTALS	21,719	60,000	3,000	1,104	589	12,116	30,200	75,986

VG 118

1.5 POWER EQUIPMENT

The principal devices in the No. 5 crossbar system are relays and crossbar switches. These require 48 volts for their operation. For this system a centralized power plant is the most economical. Reliability is assured by floating the 48-volt storage battery. However, this type of power plant is not feasible for the ESS. The ESS uses chiefly transistors requiring low voltages and small amounts of power; electron tubes requiring filament, plate, and screen supplies in the range of $1\frac{1}{2}$ to 547 volts; and cathode-ray tubes requiring filament and accelerating voltages in the range of 1,000 to 10,000 volts. This number of voltages (80 different voltages, 247 power supplies), ranging from $1\frac{1}{2}$ volts to 10,000 volts, is best supplied by regulated rectifiers. These rectifiers, in many

cases, must be associated closely with the equipment they serve. For these reasons a decentralized power system is used to secure the reliability and precision required for the ESS.

The regulated power rectifiers, which are associated with the cabinets they serve, are explained in the chapters describing these cabinets. This section describes only the power equipment common to the electronic central office.

1.5.1 Motor Alternators—Source of A-C Power

Supplying d-c power with rectifiers requires an uninterrupted source of a-c power. To obtain continuous a-c power, the gap between commercial power failure and the starting of the stand-by diesel engine is bridged by motor alternators; a photo of this equipment is reproduced in Fig. 1-14. The motor alternators are arranged in a reliable a-c power plant to supply the three a-c buses, shown schematically in Fig. 1-15. The d-c motors of the motor alternators are driven from the 130-volt battery. This battery has sufficient capacity to drive three of the four motor alternator sets. The battery is recharged through a rectifier run from the commercial power.

The commercial a-c supply (208-volt, 3-phase, 60-cycle) for the motor alternators is divided into two buses, as shown in Fig. 1-16. Two automatically

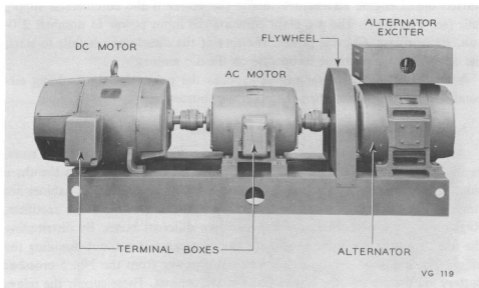

FIG. 1-14. Motor-alternator set with d-c and a-c drive motors and fly wheel.

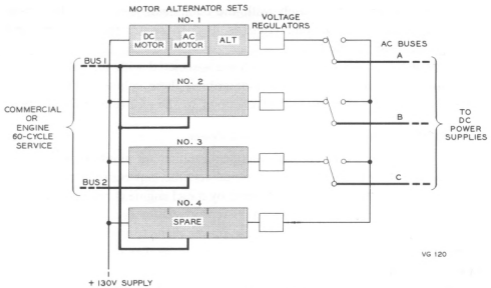

FIG. 1-15. A-C power plant.

started diesel engine alternators supply the power if the commercial supply fails (see Fig. 1-17). The a-c plant converts the input power to nominal 230-volt, single-phase, 60-cycle power. If either of the diesel engines fails to start, the office can still continue to operate on the d-c motors.

A manually started diesel engine supplies the power for the building air-conditioning equipment when the other a-c sources fail.

1.5.2 A-C Distribution for D-C Power Supplies

The cabinets of switching and power equipment are arranged in rows, as indicated by the plan shown in Fig. 1-18. Power feeders from the three single-phase 230-volt buses in the a-c and d-c power distribution cabinet are run overhead in each row. These buses supply the power to the rectifiers. Regular and spare rectifiers are connected to different buses. By distributing the rectifiers over the three buses, any one bus can fail without disabling the office. Three 48-volt d-c buses distribute d-c power from the No. 5 crossbar battery via the a-c and d-c power distribution cabinet. These supply the relays in the ESS equipment; Fig. 1-19 shows the arrangement.

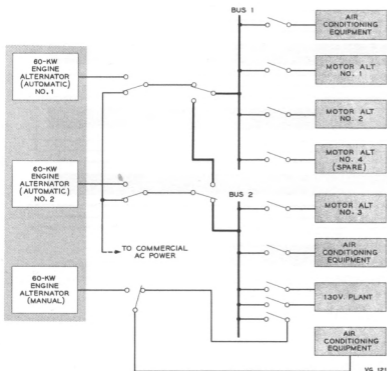

FIG. 1-16. Primary a-c distribution.

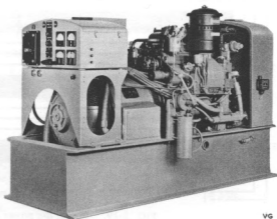

FIG. 1-17. Diesel engine alternator.

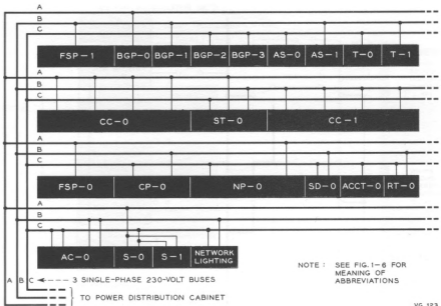

FIG. 1-18. A-c distribution for d-c power supplies.

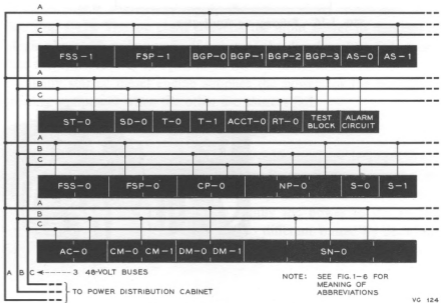

FIG. 1-19. 48-volt d-c power distribution.

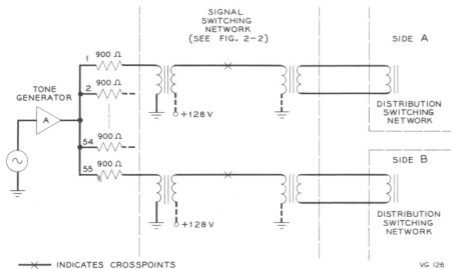

FIG. 1-20. Connection of audible ringing tone generator to the signal switching network.

1 . 5 . 3 Tone Power Supplies

The five tones required for the ESS are supplied by electronic tone generators. The tones and their frequencies are summarized in Table 1-6, on page 30. The method of applying the audible ringing tone is shown in Fig. 1-20. Here the tone generator is connected to 55 ringing switch terminations through 900-ohm matching resistors. The method of applying the dial, busy, and reorder tones is shown in Fig. 1-21. The generators for these tones are connected through 900-ohm matching resistors directly to the distribution switching network tone points. About fifteen tone points each are provided for dial, busy, and reorder tones.

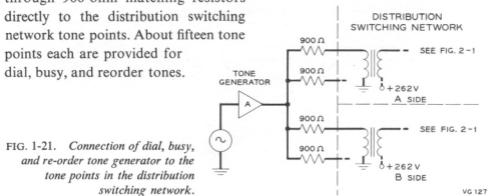

FIG. 1-21. Connection of dial, busy, and re-order tone generator to the tone points in the distribution switching network.

TABLE 1-6. TONE POWER SUPPLIES

Frequencies are given in cycles per second, cps.

Tones	Frequencies
Audible Ringing	430 cps + 454 cps; 2 seconds on, 2 seconds off
Dial Tone	560 cps + 690 cps; steady
Alert Tone	591 cps; steady
Busy Tone	560 cps + 690 cps; 0.5 second on, 0.5 second off
Re-order Tone	560 cps + 690 cps; 0.3 second on, 0.2 second off

VG 125

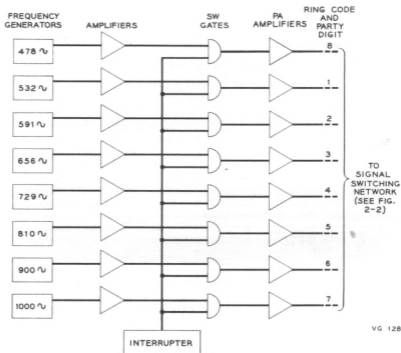

FIG. 1-22. Tone ringer power supplies.

1.5.4 Tone Ringing Power Supplies

A frequency-selective tone ringer in the customer telephone set is used to receive the tone ringing signal. This signal tone is obtained from eight frequency generators, as shown in Fig. 1-22. The ringing signal is a low-level interrupted (12.5 pulses per second) audio frequency with a duty cycle of 60 per cent "on" and 40 per cent "off." Ringing is tripped during the 40 per cent "off" period. The ringing cycle is 2 seconds on and 2 seconds off; in No. 5 crossbar it is 2 seconds on and 4 seconds off. It is applied to the customer's loop through the switching network. Eight different frequencies (478, 532, 591, 656, 729, 810, 900, and 1000 cps) are provided to operate tone ringers on single party, two-party, and eight-party lines.

1.6 STATION SETS

The power level of the audio signals that may be sent through the ESS is limited by the switching network. Therefore, a new telephone set is needed. This set, shown in Fig. 1-23, is like the 500-type set except for grilles in the side to emit tone. A partially disassembled view is given in Fig. 1-24. The set is



FIG. 1-23. Low-current tone ringer telephone set.

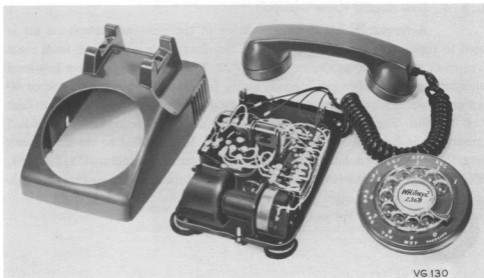

FIG. 1-24. Telephone set, internal view.

equipped with a tone-ringer circuit and a low-current transmission circuit. The dial is constructed to operate at 20 pulses per second.

The tone ringing signal on the line is received in the tone ringer circuit. A transistorized tuned-circuit amplifier and the sound radiator, Fig. 1-25, are a part of this circuit. The speech circuit uses the conventional carbon transmitter connected in a low-current transistorized transmission circuit.

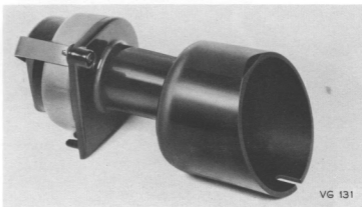

FIG. 1-25. Sound radiator.

1.7 TESTING AND MAINTENANCE PHILOSOPHY

There is a distinct difference between the No. 5 crossbar system and the ESS in maintenance and trouble-locating procedures. The No. 5 system has considerable duplicate equipment, such as senders, registers, and markers. It is possible, in the event of trouble, to stop a portion of the system, punch out a trouble recorder card, and even physically examine the apparatus before it is restored to service. In the ESS, where serial rather than parallel operation is used, this type of trouble locating is impossible. Testing and trouble locating must be done while the equipment is in operation. For this reason, the ESS has its testing features built right into the system.

Actually, the ESS is a dual system. It can detect any difference in operation between its duplicated units by making checks at a few critical points. From these checks it decides which unit is in error. Any disagreement in results triggers a test call and test patterns. These can locate at least the half of the system that is in trouble. Further diagnostic techniques using the equipment associated with the administration center help to locate the faulty equipment. As previously stated, the major portion of the ESS equipment consists of plug-in packages. This greatly simplifies the maintenance.

Two basic testing and maintenance units are furnished for the ESS: the administration center and the ESS local test cabinet. The administration center is used for testing within the office. The ESS local test cabinet is used for testing the outside plant facilities, in addition to some in-office testing. The administration center is described in subsection 1.2.8; the ESS local test cabinet is briefly described below. The office alarm system used in maintaining the office is described in Chapter 15.

ESS Local Test Cabinet

This cabinet is similar in physical appearance to the No. 3 local test cabinet used in the No. 5 crossbar system. Many of the testing operations of the ESS cabinet are the same as those of the No. 3 local test cabinet. The local test cabinets are located near each other in the No. 5 crossbar central office.

The ESS switching network does not provide a metallic path for testing customer lines. When a metallic path is needed, the ESS local test cabinet is used. It is connected to the customer's outside plant and station facilities, and to the central office equipment, by means of patching shoes. These are set up at

the vertical main distributing frame. The method of operating the local test cabinet is described in CD 1A037-01, *Telephone and Test Circuit*, and CD 1A062-01, *Jack, Key, and Lamp Circuit*.

Service Observing

Service observing for the ESS is handled in the same room as the service observing for the No. 5 crossbar system. Three No. 4A service observing sets are provided for observing on ESS lines. Each 4A set has a capacity of 40 S.O. lines. These lines terminate on jacks in the set. Thus, the three 4A sets will provide 120 S.O. lines for observing on 120 ESS lines.

The ESS lines terminate on the main distributing frame (MDF) on the first floor. These lines are connected by patching cords to a jack box at the MDF. Each patching cord has a shoe on one end for connecting to ESS lines at the MDF. The other end of the cord terminates in a jack in the jack box at the MDF. A second set of jacks in this box is wired directly to a set of jacks in the jack box in the service observing room on the second floor. This box is located close to the 4A S.O. sets.

You can easily connect any of the ESS lines to any of the S.O. lines. This is done by connecting a patching cord between the proper jacks in the box at the MDF, and then connecting another patching cord between a jack in the S.O. jack box and a jack in the 4A service observing set.

An incoming or outgoing call will light a lamp at the No. 4 S.O. set. The observer operates a key associated with the S.O. line to monitor both the conversation and the dialing. A tape recorder may be connected to the No. 4 S.O. sets.

For customer group service (CGS) installations, seven lines are provided so that one line out of seven can be connected automatically to a monitoring and dial pulse register.

Chapter 2

Method of Operation

Perhaps the best way to describe the operation of the ESS is to trace various types of calls through the system. This chapter tells, without detailed reference to circuit operations, how calls are handled by the ESS. Such descriptions are given for five types of calls, namely: an intraoffice call, a reverting call, an outgoing call, an operator call, and an incoming call. These calls are defined briefly in the paragraphs below. Dial tone and dialing connections, shown in Fig. 2-1, are set up for all but the incoming calls.

An intraoffice call is a call between two customers who are served by the ESS on different lines. Figure 2-2 shows the connections for regular ringing, audible ringing, and talking.

A reverting call is a call between two party-line customers served by the same line. The ringing and talking connections for this call are shown in Fig. 2-3.

An outgoing call from a customer to another office is connected to an outgoing trunk. The talking connection for such a call is shown in Fig. 2-4.

An operator call is a call or call condition that results in calling in the operator at the 3CL switchboard. Operator calls include calls for assistance (zero operator) and such call conditions as permanent signal, partial dial, vacant code, and denied service. The talking connection is like that shown for an outgoing call in Fig. 2-4.

An incoming call is connected to the called customer over an incoming trunk from the connecting office. Figure 2-5 shows the connections for regular and audible ringing, and for talking.

Generally the calling and called customers are connected to opposite sides of the distribution switching network. Sometimes this cannot be done, and two A sides or two B sides must be used. In this case, a skew ringing connection is set up, as shown in Fig. 2-6. When the called customer answers, the skew connection is then used as the talking path.

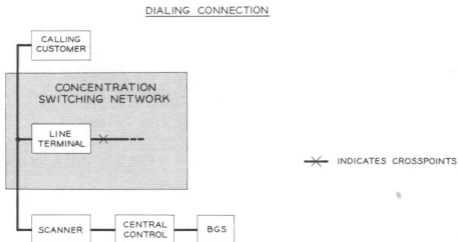
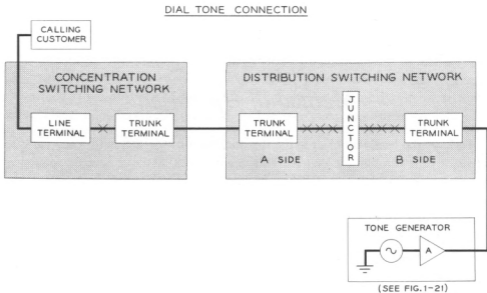

FIG. 2-1. Connections for dial tone and for dialing.

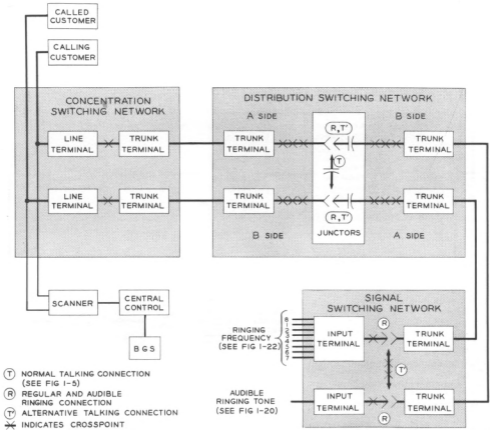
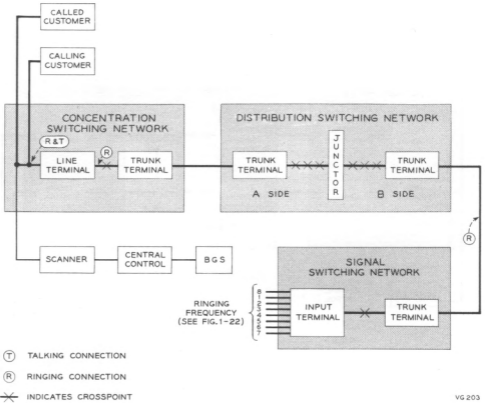

FIG. 2-2. Connections for an intraoffice call, showing the paths for regular ringing, audible ringing, and talking.

VG 202



VG 203

FIG. 2-3. Connections for a reverting call: ringing and talking paths.

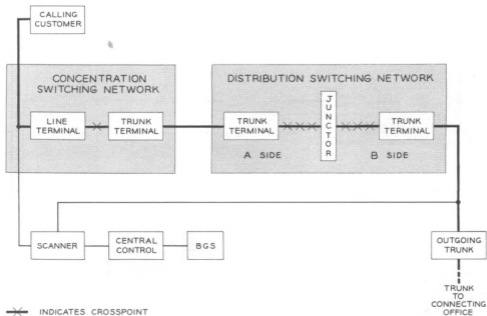

FIG. 2-4. Talking connection for an operator call or an outgoing call.

VG 204

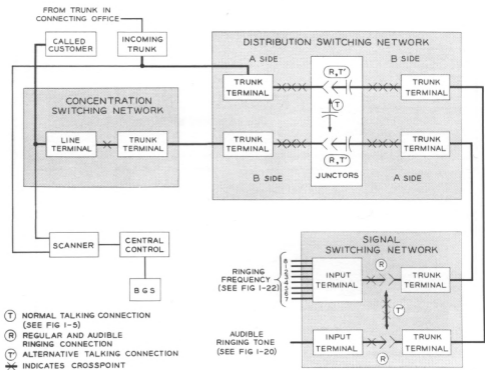

FIG. 2-5. Connections for an incoming call, showing the paths for regular ringing, audible ringing, and talking.

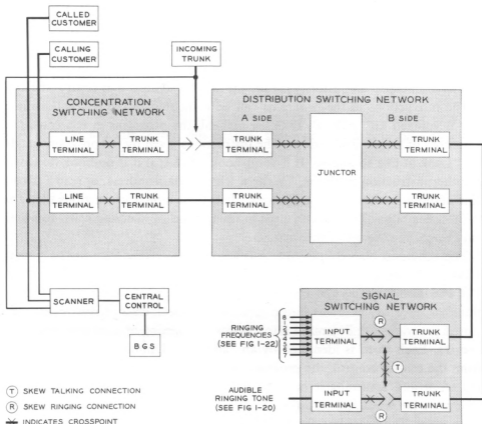

FIG. 2-6. Skew ringing and talking connections for an intraoffice call or an incoming call.

VG 206

The Stored Programs

Chapter 1 was concerned mainly with the actions of the major components used in handling a telephone call. These actions are tied together by a series of instructions known as the stored "programs." Before tracing a call, let us discuss the programs for a moment.

These programs contain orders or instructions for handling a particular system routine and for processing calls. They determine the sequence and time limitations, if any, for the individual routine and instructions. A main program acts as a timetable and priority list for the other programs that control the ESS.

The instructions in the programs can be compared to the instructions in a "do it yourself kit" manual. Like the manual, the programs in ESS consist of a number of simple instructions. The instructions given by the programs might be, "Look at line so-and-so. If it is off-hook do this; if it is on-hook do that." Another instruction might be, "Write a 1 in a certain address, or read a particular address in the barrier grid store." It is these stored instructions that give the ESS flexibility. To make changes in the method of handling calls, you need only to change the set of instructions.

The programs also contain the instructions for making tests of the system.

All programs are stored on photographic plates in the flying spot store (FSS). The FSS also contains the translation information that makes it possible to translate directory numbers into equipment numbers, class of service, etc. The stored programs are organized into "words" consisting of combinations of 1's and 0's. Each word is identified by an "address." Upon receiving an address from the central control, the program storage (FSS) reads out the corresponding word and transmits it back to the central control. The central control interprets the word and transmits an appropriate request to the other units in the system. The programs are described in more detail in Chapter 9.

2.1 ESTABLISHING THE DIALING CONNECTION—FIG. 2-7

Each customer line has two spots assigned to it in the barrier grid tube (BGT). We will call these the line spots, L1 and L2. By a charge or no charge on these spots, the ESS can determine the state of the customer line. In the language of the ESS, which is all in terms of 1's (charge) and 0's (no charge), we use the combination 00 to mean "the line is idle"; the combination 10 to

mean "the line is in the busy or talking state"; and the combination 01 to mean "the line is presently being served by the system."

The system is not designed to look at any one line continuously, but to look at all the lines periodically. The stored program directs a scan of each customer line on a one-at-a-time basis every 100 milliseconds. The system compares the line to the line spots in the BGT. The system then knows whether any change has occurred on a customer line since the last previous look. If no change has occurred, it proceeds with the scan of the other lines. Suppose the scanner detects a change (off-hook) in a customer line, and a comparison of the line spots with the scanner reading indicates that on the last previous look the line was idle. From this change, the system now concludes that this line has just made a service request; see Fig. 2-7, connection 1.

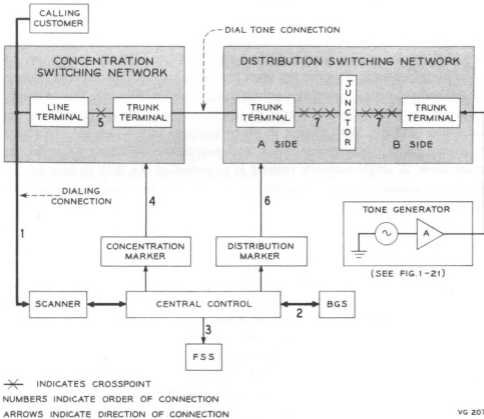

FIG. 2-7. Establishing a dialing connection.

Some way is needed to keep track of this line and to record the information received from it. This is done by taking a vertical column of spots in the erasable memory (BGT) and giving it the job of recording the information on the origin of a call. This column of spots is called an originating register. Enough originating registers are provided to handle all the calls that are in the originating state at the same time. The system selects an idle originating register, makes it busy, and assigns it to the customer line; this is done through connection 2 in the figure. The calling customer scanner address (equipment number) is stored in this originating register. Now the central control directs the scanner to continue with a 100-millisecond scan of the next line.

2.1.1 Dial Tone Connection—Fig. 2-7

The central control starts to prepare the dial tone connection as soon as the equipment number of the calling line is stored in the originating register. The dial tone trunks have T3 spots assigned to them in the BGT. These spots are used by the central control to find and select an idle dial tone trunk. A translation program using the FSS gives the central control the network address of the dial tone trunk selected; connections 2 and 3 in Fig. 2-7. The next step is to connect the calling customer to the dial tone trunk in the distribution switching network. With respect to other functions in the ESS, the operations that take place in the concentration and distribution switching networks are quite slow. A single network register is provided in the BGT to care for all functions associated with these slower actions, so the more rapid functions in the office can continue.

On a program order from the FSS, the central control directs the concentration marker to set up a connection in the concentration switching network, connection 4. The concentration marker places a voltage on the calling customer line terminal address, and places ground on the idle concentrator trunks to either the A or B side of the distribution switching network, as directed. A gas diode crosspoint fires and sets up a path from the customer line terminal to the concentrator trunk; connection 5. The figure shows the connection to the A side of the distribution switching network. The distribution marker sets up the connections in the distribution switching network, through connection 6. The addresses of the concentrator trunk and the dial tone trunk selected are known by the central control. Voltages are placed on these address points. These points are the concentrator trunk, A side, and the dial tone trunk, B

side, of the distribution switching network. All idle gas diode crosspoints between the marked ends fire. However, only one junctor is made active for this connection; thus only one complete path is set up. The concentrator trunk is connected to a dial tone trunk through six fired gas diode crosspoints and one junctor; this is connection 7.

2 . 1 . 2 Dialing Connection

Having given the calling customer dial tone, and having assigned an originating register to the line, the system now waits to record the dial pulses. As mentioned before, each customer line is scanned every 100 milliseconds. But during dialing, the pulses have a width of some 50 milliseconds. Scanning the line every 100 milliseconds is not often enough to be sure that all pulses are detected. Some pulses might slip through the 100-millisecond scanning rate. So the program must prescribe that the system scan, *every 10 milliseconds*, each line that is in an originating register. Changes on the line due to dialing are detected by providing a "last look" spot in the originating register. Here is recorded the state in which the line was when last seen. The "last look" spot is compared with the line condition as found by the scanner. When a change is found, the system takes appropriate action. Thus, it can detect and count the pulses of a digit; and by timing, it separates the pulses of one digit from the pulses of the next digit. These digits are stored in a group of spots in the originating register called digit slots.

After the first digit is dialed, the central control consults the "recent change" register in the BGT and the translation area of the FSS, to determine the class of service of the calling customer. This information is then stored in the originating register. The central control also examines the digit slots in the originating register after each digit to see whether any action need be taken.

While the calling customer is receiving dial tone, a follow-up procedure is undertaken by the system. The distribution marker reports back to the central control that the connections in the distribution switching network have been set up. When the first dial pulse is detected, the program directs the central control to knock down the dial tone connection. This prevents the calling customer from hearing dial tone while dialing.

The basic operations for starting any type of call now have been completed. The operations that set up the connections for different types of calls are described in the following sections of this chapter.

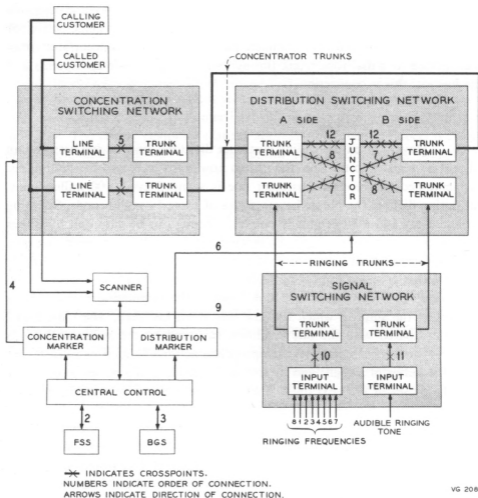

VG 208

FIG. 2-8. Establishing an intraoffice call.

2.2 INTRAOFFICE CALL—FIG. 2-8

Now let us trace an intraoffice call within the ESS. The calling customer connection to the A side of the distribution switching network, via a concentrator trunk, Fig. 2-8, connection 1, was described in subsection 2.1.2 on the dialing connection. The following description covers the action after the seventh digit has been dialed.

Through a translation program, the system consults the "recent change" register in the BGT and the translation area of the FSS. Here the directory number of the called customer is translated to an equipment number. This translation also informs the central control of the class of service and ringing code of the called customer. The called customer line spots in the BGT are then examined. Their address is also found from the translation. The condition of the line spots informs the central control of the state of the called customer line, such as idle, busy, or dialing. If the called customer line spots show "idle" (00), they are put in the "line being served" condition (01). This temporary record tells the central control that this address is being served by the system; connections 2 and 3, Fig. 2-8.

If the called customer line is idle, the central control orders the concentration marker, via address leads, to set up a connection in the concentration switching network, using connection 4. A talking and signaling path is now set up between the called customer line terminal and a concentrator trunk having an appearance on the B side of the distribution switching network; this path is connection 5. The next step is to set up a ringing frequency to the called customer, and audible ringing tone to the calling customer.

The central control consults the FSS to locate the activity (T3) spots of the ringing trunks and then directs this number to the BGT. By selectively looking at the activity spots of the ringing trunks, the central control is able to obtain the address of an idle one. The central control takes this address and orders the distribution marker to set up, through connection 6, the ringing connections in the distribution switching network. A voltage is placed on the concentrator trunk terminal on the B side of the distribution switching network, and on the ringing trunk terminal on the A side. The gas diode crosspoints fire, and a path is set up between them, connection 7. The same action takes place between the concentrator trunk terminal on the A side and the ringing trunk terminal on the B side of the distribution switching network. Again, gas diode crosspoints fire, and a connection is made, connection 8. The central control then directs the concentration marker to set up, through connection 9, the proper ringing frequencies to the ringing trunk. The concentration marker first sets up the proper ringing frequency to the called customer and audible ringing tone to the calling customer. Conducting gas diode crosspoints connect the ringing frequency and the audible tone to the ringing trunks, through connections 10 and 11. When the ringing connection is set up, the calling customer

line spots in the BGT are put in the "talking" state. The called line number is put into a ringing register in the BGT, and the originating register is released. The program specifies that any line in a ringing register shall be scanned periodically for an answer.

When the called customer answers, the network is requested to take down the ringing connections, connections 7 and 8, and put up a talking connection. This is done in a series of steps under control of the network programs in the FSS. The distribution marker places a mark voltage on the called and calling customer concentrator trunk terminals on the A and B sides of the distribution switching network. The mark voltage on each concentrator trunk terminal causes the gas diode crosspoints on many idle paths to fire. But only one junctor is made active; thus only one complete path through the distribution switching network is set up, connection 12. The line spots of the called customer, in the BGT, are put in the "talking" state. During the "talking" state, no registers are needed for the call.

After the talking path is set up, the program directs the concentration marker to release the ringing frequency and audible tone connections to the ringing trunk terminals, connections 10 and 11. If no idle paths are available through the distribution switching network, the ringing trunk is used as the talking path (see Fig. 2-2).

A scanner comparison of the customer line with the line spots in the BGT indicates when a disconnect occurs on a line. To make sure this is a valid disconnect and not a hit, a disconnect register in the BGT is assigned to the disconnecting customer. The disconnect register contains the disconnecting customer's scanner address. If, after three 100-millisecond scans, a disconnect condition still exists, the network register is directed to remove the talking connection.

2.3 REVERTING CALL—FIG. 2-9

As mentioned previously, a reverting call is a call between two customers (parties) on the same line. This call differs from other local calls in that eight digits are dialed. The last digit identifies the calling party. The calling party connection to a concentrator trunk was described in subsection 2.1.2 on the dialing connection; this connection is shown in Fig. 2-9 as connection 1. The calling party line is assigned to an idle originating register in the BGT, which stores the dial pulses.

5/17
6-29-62
→

After receiving the seventh digit, the system consults, via the translation program, the "recent change" register in the BGT and the FSS. This translation informs the central control of the line equipment number and the ringing code of the called party. These it stores in the originating register, connections 2 and 3. The called party line spots in the BGT are examined, using the address obtained from the translation. If the scanner addresses (equipment numbers) of both the calling and called parties match, the central control knows that this is a reverting call. The originating register is directed to wait for ten to twenty seconds for the eighth digit. This digit gives the central control the ringing

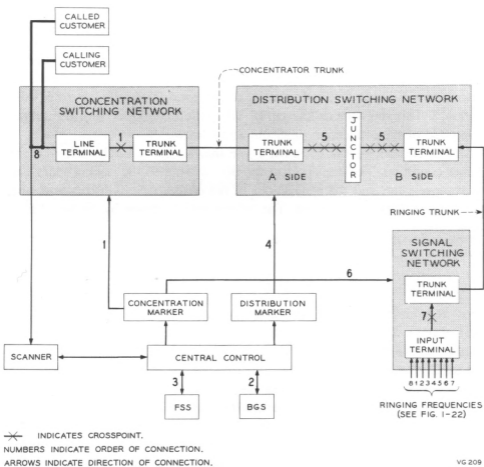

FIG. 2-9. Establishing a reverting call.

code of the calling party. If the eighth digit is not dialed, the calling party is directed to a partial dial trunk. After the eighth digit, the information stored in the originating register is transferred to an idle reverting call register, and the originating register is released.

When the calling party hangs up, the scan of the calling line detects the on-hook condition and informs the central control. The central control directs the distribution marker, over address leads, to set up the ringing connection, connection 4. A mark voltage is put on the calling party's concentrator trunk terminal on the A side and the idle ringing trunk terminal on the B side of the distribution switching network. Gas diode crosspoints fire and set up a path between them, connection 5.

The central control directs the concentration marker to set up the correct ringing frequency in the signal switching network, connection 6. Gas diode crosspoints connect the ringing frequency to the called party, connection 7. After one ringing interval, the connection in the signal switching network is released and a different ringing frequency is connected to the ringing trunk, connection 7. This rings the calling party. This action continues until the answer is detected or the connection times out and releases.

A directed scan of the customer's line informs the central control of the answer condition. The line spots in the BGT are put in the talking state. The reverting register, and the connections in the concentration, distribution, and switching networks are released. The talking path is shown by the heavy line, connection 8.

2.4 OUTGOING CALL—FIG. 2-10

Outgoing calls are calls that originate in the ESS and terminate in another office. Calls to the Morris extended area offices, and to Morris customers not assigned to the ESS, are switched by the No. 5 crossbar office. The signaling and talking path between the two offices is set up over an outgoing trunk.

For example, let us assume an ESS customer dials the number of a customer terminating in the No. 5 crossbar office. The calling customer connection to a concentrator trunk, connection 1 in Fig. 2-10, was described in subsection 2.1.2 on the dialing connection. After receipt of the seven digits, the central control consults the "recent change" register in the BGT and the translation area of the FSS, through connections 2 and 3 in Fig. 2-10. The translation it receives

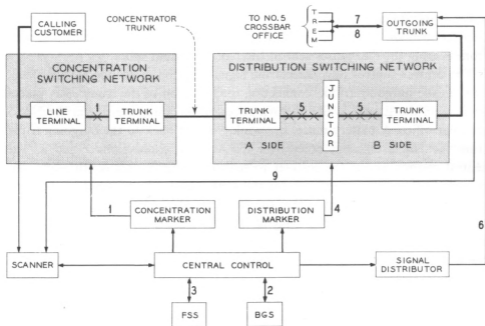

✕ INDICATES CROSSPOINT.
 NUMBERS INDICATE ORDER OF CONNECTION.
 ARROWS INDICATE DIRECTION OF CONNECTION.

VG 210

FIG. 2-10. Establishing an outgoing call.

informs the central control that this is a customer in the No. 5 crossbar office. The information stored in the originating register, the originating line class of service, the scanner address, and the dialed digits are now transferred to an outpulsing register in the BGT. The originating register is then released. A translation program gives the location of the activity spots (T3) in the BGT of the outgoing trunks. The activity spots (T3) of the outgoing trunks to the No. 5 office are then examined to find an idle trunk. An idle outgoing trunk is found, made busy, and its equipment address determined from the FSS. The central control passes the outgoing trunk address to the distribution marker to set up a connection in the distribution switching network, connection 4. A connection is set up from the calling customer's concentrator trunk terminal on the A side to the outgoing trunk terminal on the B side of the distribution switching network, connection 5. Another translation program (using the outgoing trunk terminal address) provides the central control with the scanner

address and the signal distributor address of the trunk. The network connection (connection 5) is then released. This is to prevent the calling customer from hearing the dial pulses sent to the No. 5 crossbar office.

The central control now directs the signal distributor to operate the trunk relay in the outgoing trunk, connection 6. Operation of the trunk relay places ground on the E lead, which in turn seizes an incoming register in the No. 5 crossbar office. A battery pulse, or "wink," is sent back to the outgoing trunk from the No. 5 crossbar office over the M lead, connections 7 and 8. The central control directs the scanner to scan the outgoing trunk (through connection 9) every 50 milliseconds for the wink signal. The presence of the wink signal tells the central control that the No. 5 crossbar office equipment is ready to receive dial pulses. After a delay of 70 to 80 milliseconds, the system directs the signal distributor to pulse the digits stored in the out-pulsing register. Only the last four digits are outpulsed. The signal distributor pulses the trunk relay in the outgoing trunk at 20 pulses per second, through connection 6. The relay operation in turn transmits ground pulses over the E lead to the No. 5 crossbar office. Before pulsing the last digit, the central control directs a scan of the calling customer line to check whether it is still "off-hook."

After the last digit has been pulsed, the central control directs the distribution marker to set up, through connection 4, a connection in the distribution switching network. A path is set up again between the calling customer concentrator trunk terminal and the outgoing trunk terminal, connection 5. The network register and outpulsing register are then released. On EAS point calls, seven digits are outpulsed.

A directed scan of the outgoing trunk by the scanner informs the central control of the answer and disconnect of the called customer in the No. 5 crossbar office. This answer or disconnect signal is given through connection 9 by the presence or absence of battery on the M lead from the No. 5 crossbar office.

2.5 INCOMING CALL—FIG. 2-11

Since there are no direct trunks from other offices terminating in the ESS, all incoming calls are routed through the No. 5 crossbar office. Connections are set up to the ESS over incoming trunks. A call from a customer in the No. 5 crossbar office or from an operator to a customer in the ESS is also treated as an incoming call.

A No. 5 crossbar customer dials the directory number of an ESS customer. The number group translation in the No. 5 crossbar office directs its completing marker to route advance from an intraoffice to an outgoing call and to seize an idle outgoing trunk to the ESS. This seizes an incoming trunk in the ESS by placing battery on its M lead. The scan of the incoming trunk by the scanner detects this battery, through connection 1 on Fig. 2-11. The ESS now knows that this is an incoming call.

The central control examines the activity spots of the incoming registers in the BGT, selects one, makes it busy, and assigns it to the incoming trunk;

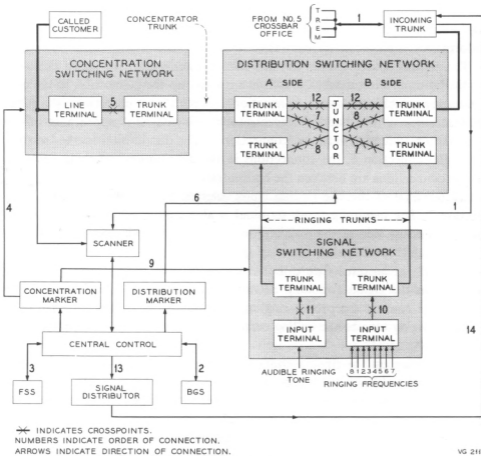

FIG. 2-11. Establishing an incoming call.

connection 2. The incoming trunk spots (T1-T2) in the BGT are marked to indicate that it is being served by the system. Four digits are outpulsed from the No. 5 crossbar office. These pulses are stored in digit slots in the incoming register in the BGT. After receiving the fourth digit, the central control examines the "recent change" register in the BGT and the translation area in the FSS; connections 2 and 3. The directory number is translated to obtain the scanner address, class of service, and ringing code of the called customer. The line spots of the called customer in the BGT are examined to see whether the called customer line is idle. If idle, the line spots are marked to indicate the line is being served by the system.

The central control seizes the network register and gives it the scanner address of the incoming trunk. A translation of the scanner address is made to obtain the address of the incoming trunk in the distribution switching network. This information is stored in the central control.

The central control passes the line terminal address of the called customer to the concentration marker, which in turn sets up the connection in the concentration switching network, connection 4. A path is set up between the called customer line terminal and a concentrator trunk with an A appearance on the distribution switching network, connection 5. The distribution marker sets up, through connection 6, the connections in the distribution switching network. These connections are between the concentrator trunk terminal and the ringing trunk terminal of the idle ringing trunk selected by the central control, connection 7. The incoming trunk terminal is also connected to a ringing trunk on the opposite side of the distribution switching network, connection 8. The selection and operation of the ringing trunks are the same as described in Section 2.2 for an intraoffice call. The concentration marker sets up the connections in the signal switching network, connection 9. Operated gas diode crosspoints connect the proper ringing frequency to the called customer, and audible ringing tone to the calling customer in the No. 5 crossbar office, connections 10 and 11.

After setting up the ringing connections, the information stored in the incoming register (the called line address, the signal distributor address, etc.), is all transferred to a ringing register, and the incoming register is released. The incoming trunk spots in the BGT are put in the "talking" state. The called customer line is scanned periodically for an answer.

When the scanner detects the answer of the called customer, the central control directs the network to take down the ringing connections, connections

7 and 8, and set up the talking connection, connection 12. This connects the called customer to the incoming trunk as shown by the heavy lines on Fig. 2-11. The called customer line spots in the BGT are put in the "talking" state. The central control now calls upon the signal distributor to indicate an answer condition to the No. 5 crossbar trunk, connection 13. The signal distributor address of the incoming trunk is stored in the ringing register. The signal distributor operates the trunk relay in the incoming trunk, connection 14. The trunk relay places ground on the E lead to hold up the connection in the No. 5 crossbar office. The signal switching network, connections 10 and 11, and the ringing register are released.

If the called customer disconnects first, the comparison of the called line condition with the called line spots in the BGT indicates a disconnect. A disconnect register is then assigned to the disconnected customer. If the disconnect condition still exists after three 100-millisecond scans, the network register is directed to remove the talking connection.

If the No. 5 crossbar customer disconnects first, battery is removed from the M lead and the incoming trunk scan point. A comparison of the incoming trunk scan address with its trunk spots in the BGT indicates a disconnect from the No. 5 crossbar office.

2 . 6 CALLS TO THE 3CL SWITCHBOARD—FIG. 2-12

2 . 6 . 1 Recording-Completing ("Zero" Operator)

When an ESS customer dials "0" (zero), he is connected through the distribution switching network over a separate group of recording-completing trunks to the 3CL switchboard. The operator answers these calls in the same manner as the No. 5 crossbar customer calls.

The calling customer connection to a concentrator trunk, shown as connection 1 in Fig. 2-12, was described in subsection 2.1.2 on the dialing connection. After the first digit has been dialed, the central control examines the digit slots in the BGT originating register. It finds that a "0" has been dialed. This tells the system to proceed with the program that deals with the handling of operator calls.

The central control consults the "recent change" register in the BGT and the translation area of the FSS, connections 2 and 3 of Fig. 2-12. This translation gives the central control the class of service of the calling customer. The central

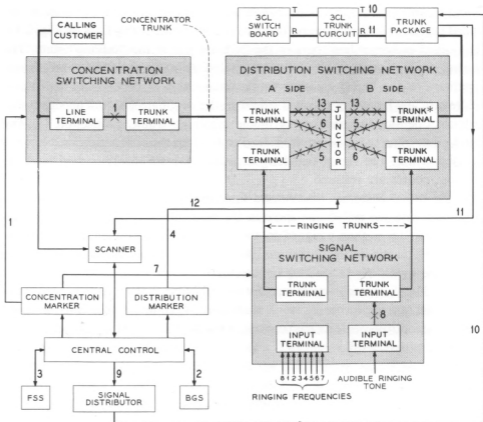

✕ INDICATES CROSSPOINTS.

NUMBERS INDICATE ORDER OF CONNECTION.
ARROWS INDICATE DIRECTION OF CONNECTION.

* REPRESENTS AN OPERATOR TRUNK, DENIED SERVICE TRUNK,
PARTIAL DIAL TRUNK, OR PERMANENT SIGNAL TRUNK.

VG 212

FIG. 2-12. Establishing calls to the 3CL switchboard.

control looks at the activity (T3) spots of the ringing trunks in the BGT. These spots are used to tell the busy-or-idle condition of the trunks. The central control selects an idle trunk, makes it busy, and consults the FSS to obtain the address in the distribution switching network of the ringing trunk it has selected.

In addition to the trunk spots (T1 and T2), a T3 spot is assigned to the operator trunks. The central control selects an idle operator trunk in the same manner that it selected a ringing trunk. Now it has the addresses of the ringing

trunk and the operator trunk, and it directs the distribution marker to set up the ringing connection, connection 4.

The distribution marker, via marking leads, places mark voltages on the ringing trunk terminals, the concentrator trunk terminal, and the operator trunk terminal in the distribution switching network. Gas diode crosspoints fire and set up a connection between the customer concentrator trunk and a ringing trunk, connection 6; they also set up another connection between a ringing trunk and the operator trunk, connection 5.

The concentration marker directs the connections in the signal switching network, connection 7. A voltage on the ringing trunk terminal and on the input terminal causes a gas diode to fire. This connects the audible ringing tone to the calling customer, connection 8. The connection between the ringing frequency input terminal and the ringing trunk terminal is not made on this call because we don't want to send ringing toward the 3CL switchboard.

A translation program determines the scanner address and the signal distributor address from the network selector address of the selected operator trunk. The trunk spots (T1 and T2) in the BGT are put in the talking state, and the central control directs the signal distributor to signal the operator, connection 9. A ground from the signal distributor, through the trunk package and over the tip lead, operates a relay in the 3CL trunk circuit, connection 10. The operated relay lights the incoming lamp at the 3CL switchboard. The calling customer line spots (L1 and L2) in the BGT are put in the talking state.

A ringing register is assigned to the call, and a directed scan is made of the trunk scanner address every 80 milliseconds. When the operator answers the signal, ground is placed on the trunk lead to the scanner, connection 11. The scan of the trunk, with the presence of this ground, tells the central control that the operator has answered. The ringing register is then released. The central control directs the distribution marker to release the ringing connections and to set up a talking path, connection 12. The ringing connections 5 and 6 are released; and the talking path, connection 13, is set up between the calling customer and the operator trunk. If a talking path cannot be set up through the distribution switching network, the ringing trunk is used for the talking path.

An operator trunk register in the BGT is permanently associated with each operator trunk, each denied service trunk, each partial dial trunk, and each permanent signal trunk. It stores the information concerning an operator call such as the address of the connected line. Calls to the operator require a complete disconnect of both the line and the associated trunk to release the connec-

tion. This arrangement is made so that the operator can hold a connection while attempting to complete a call.

When the calling customer disconnects, it is detected by the supervisory scan of the customer line. A disconnect register in the BGT is assigned to the call, and the system enters a program to release the talking connection. The L1 and L2 line spots of the customer line are put in the "line being served" state (01). The disconnect register waits through three 100-millisecond scans to see that it is an actual disconnect and not an accidental hit. However, in the process of releasing the talking connection, the system learns that the customer was connected to an operator. An operator disconnect timing register is then assigned to the call, and the disconnect register is released. The talking path through the network between the customer and the trunk is set up again. The signal distributor removes the ground from the 3CL trunk circuit, connection 10. This causes a disconnect signal on the operator's cord. The operator trunk register is informed of the customer disconnect. The operator removes her cord, and the supervisory scan of the trunk tells the system that she has disconnected. Another operator disconnect timing register is assigned to the operator trunk end of the call. The T1 and T2 trunk spots are put in the "trunk being served" state (01). After a timing interval, the operator trunk register finds that the customer has disconnected, but the talking connection through the network still exists. Now the network connections are released, and the operator trunk register is informed that the operator has disconnected and that the network connections have been released. The customer line spots and the trunk spots are put in the "idle" state (00), and the operator disconnect timing registers are released.

When the customer disconnects, and after an operator disconnect timing register is assigned to the call, the program directs a scan of the customer line every 100 milliseconds. This is to see whether the customer goes off-hook again to flash the operator. If the off-hook condition is noted within 700 to 800 milliseconds, a one-half second on-off flashing of the operator trunk is started. The timing continues for another second, and if the customer is still off-hook, the flashing is stopped. The operator disconnect register is released and the network connections retained. If the scan of the customer line does not show an off-hook condition within 800 to 900 milliseconds (not flashing), a disconnect is assumed. The program continues with the disconnect operations as previously described.

There is no re-ring feature provided in the ESS. On delayed calls, therefore, the operator must recall the calling customer over a No. 5 crossbar toll switching trunk by dialing the last four digits of the customer's telephone number.

2 . 6 . 2 *Permanent Signals*

As mentioned before, the scan of the customer line informs the ESS of a request for service. If, after 10 to 20 seconds, the scan of the line shows no change (no dialing taking place), a time-out occurs, and the system enters a program to direct the line to permanent signal. The dial tone connection is released, and the customer line is connected through the distribution switching network to a permanent signal trunk. The selection and operation is the same as for the recording-completing trunks, subsection 2.6.1, Fig. 2-12. The ESS trunk circuit for permanent signals is the same as that used on the zero operator calls.

The operator answers a permanent signal trunk by plugging a cord into the switchboard ANS jack. Only the regular cord circuit is used. The permanent signal cord circuit which provides for testing, ringing, and howler tones to the permanent signal trunks in the No. 5 crossbar office *should not* be used with ESS trunks. If the customer is contacted, he is instructed to hang up. When he hangs up, the operator removes her cord and the line is restored to normal. If the customer can not be contacted, or in case of line troubles, the operator plugs another cord into the switchboard TST jack associated with the trunk. This causes the teletypewriter at the administration center to print a trouble record. This tells the maintenance man which line has a permanent signal. The operator then removes both her cords. The permanent signal connection is released, but the line spots in the BGT are put into the "busy" state. The line will remain in the busy state until the customer hangs up, or until the trouble is corrected. If the customer line number is desired, and if the operator wants to hold the permanent signal trunk, she does not remove the cord from the ANS jack. If she wants the line number of the permanent signal, she calls the administration center.

If all the permanent signal trunks are busy, or if the connection in the network is blocked, the system tells the teletypewriter to print a record of all the permanent signals.

2.6.3 *Partial Dial*

If an ESS customer fails to dial the required number of digits within the time-out period (10 to 20 seconds), the call is routed to a partial dial trunk. The same type of ESS trunk circuit is used as for the zero operator trunks. The selection and connections through the switching networks are also the same.

The partial dial trunks terminate in the miscellaneous answering jacks at the 3CL switchboard. Two sets of jacks are provided, ANS and TST, so the operator may hold the connection and signal the teletypewriter to print a trouble record.

2.6.4 *Vacant Codes*

A separate group of trunks for vacant codes is not provided in the Morris ESS. When the system translation finds that a vacant code has been dialed, the call is routed to the operator over a regular ESS zero operator trunk. The operator answers, and decides how the call should be handled. The connection is released when the customer hangs up and the operator removes her cord.

2.6.5 *Denied Service*

The same type of ESS trunk circuit is used for the denied service as for the zero operator calls. If an ESS customer, to whom outgoing service is denied, attempts a call, he will be routed, after dialing, to a denied service trunk. The operator answers, and follows the usual method for handling these calls. The connection is released when the customer hangs up and the operator removes her cord.

Chapter 3

The Switching Networks

The concentration switching network, the distribution switching network, and the signaling switching network are collectively called the switching networks. These networks provide the voice transmission and signaling paths between telephone customers.

The concentration switching network has direct access to every customer line. Through gas diode crosspoints, it can connect any customer line to a concentrator trunk on either the A side or the B side of the distribution switching network.

Each concentrator trunk has an appearance in the distribution switching network. The distribution switching network has two sides called A and B (see Fig. 1-5, Chap. 1). There are 135 concentrator trunks appearing on the A side and 135 concentrator trunks appearing on the B side. The calling customer and called customer lines terminate on opposite sides of the distribution switching network (A and B). Operated gas diode crosspoints connect them together. The transmission and signaling path through the concentration switching network and the distribution switching network is over one wire to ground.

Other trunks, such as the dial tone, busy, and ringing trunks, as well as trunks to the 3CL switchboard and the No. 5 crossbar office, also have appearances on the A and B sides of the distribution switching network. Operated crosspoints connect them to the customer via a concentrator trunk on each side of the distribution switching network.

The signal switching network connects the ringing frequencies to the called customer line. The concentration, distribution, and signal switching networks are each described separately in this chapter.

The network plan objective, traffic-wise at least, is to permit connections among many lines or trunks with as few crosspoints as possible. A crosspoint

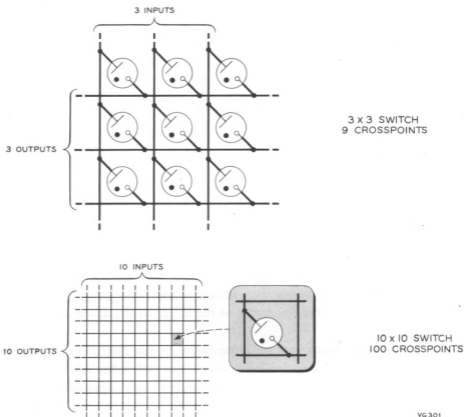

FIG. 3-1. A typical 3-by-3 switch and a typical 10-by-10 switch.

is simply a switch element. In No. 5 crossbar offices this is a metallic contact at the intersection of a horizontal and vertical in a crossbar switch. In the Morris ESS the crosspoint is a gas diode.

Two typical gas diode switches are shown on Fig. 3-1. Here you see a 3-by-3 switch that will switch between 3 inputs and 3 outputs. It contains 9 crosspoints. By selectively making these crosspoints conducting, paths are set up as desired between any input and any output. Likewise, a 10-by-10 switch constructed in this manner contains 100 crosspoints. As the number of inputs and outputs greatly increases, the number of crosspoints required becomes enormous. For example, a switch to handle a thousand input terminals and a thousand output terminals in this way would require a million crosspoints.

The number of crosspoints required can be reduced substantially, however, by using switches in successive stages. The method of achieving such a reduction can be demonstrated with the aid of Fig. 3-2. This figure represents a network with 27 inputs and 27 outputs. To give each input terminal access to each output terminal through a single switch would require a total of 27×27 or 729 crosspoints.

In the figure (Fig. 3-2) are shown thirty-six 3-by-3 switches organized in four stages. There are nine of those switches in each stage. Each input terminal has access, through its first-stage switch, to three switches in the second stage. Each switch in the second stage has access to three switches in the third stage. Thus each input terminal has access, through the switches in the first and second stages, to *any* switch in the third stage. The lines connecting the switches in the drawing show these access paths. One set of lines has been made heavy to indicate that three paths exist between any input terminal and any output terminal in this four-stage arrangement.

36
324
324 - 36 small
729 - one cross.

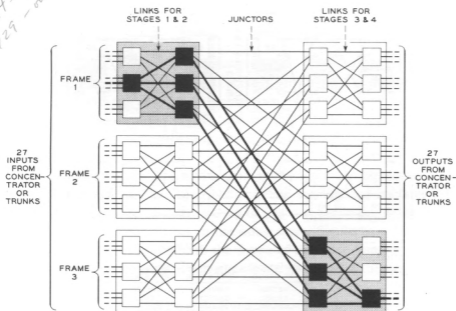

FIG. 3-2. Four-stage network wiring pattern.

VG 302

The thirty-six switches in the network of Fig. 3-2 have nine crosspoints each. This makes a total of 36×9 or 324 crosspoints to take care of 27 input terminals and 27 output terminals, instead of the 729 crosspoints which would be needed in a single-stage 27-by-27 switch. For a thousand input terminals and a thousand output terminals, a four-stage network could be designed with four hundred 10-by-10 switches, using 40,000 crosspoints instead of the million crosspoints required by a single-stage switch. Such an arrangement would represent a 25-to-1 reduction in the number of crosspoints required.

3.1 THE DISTRIBUTION SWITCHING NETWORK

The Morris ESS contains a six-stage switching network. Stages 1, 2, 5, and 6 contain 10-by-10 switches (ten inputs and ten outputs in each switch). There are twenty switches to a frame, and four frames (numbered 0, 1, 2, and 3). Stages 3 and 4, which make up the junctor wiring, each contain ten half-frames (numbered 0 through 9). Stages 3 and 4 contain both 4-by-4 and 4-by-2

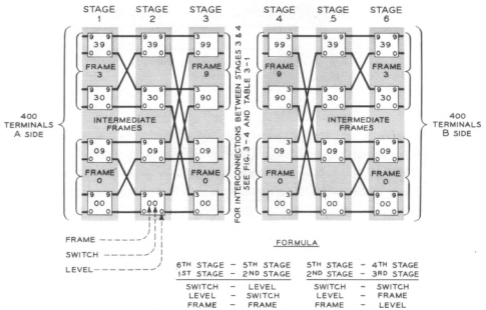

FIG. 3-3. Distribution switching network, six-stage wiring pattern.

switches. Frames 0, 2, 3, 7, and 9 have 4-by-4 switches, and frames 1, 4, 5, 6, and 8 have 4-by-2 switches.

This arrangement provides 400 terminals on each side of the network with a maximum of 300 junctors. The wiring pattern is shown in Fig. 3-3. Ten switches in the first stage are wired to ten switches in the second stage in each frame. The wiring between these stages follows the standard crossbar pattern. If we refer to these stages by switch and level (as in No. 5 crossbar) we see that switch and level in the first stage are wired to level and switch, respectively, in the second stage within the same frame. For example, switch 0 level 9 in the first stage is wired to switch 9 level 0 in the second stage. Between the second and third stages the pattern changes; the wiring is distributed between frames. Switch 0 is wired to switch 0; the output level on the switch in stage 2 coincides with the frame it is wired to; and the frame of stage 2 determines the level in stage 3. So we can say that between stage 2 and stage 3, switch is wired to switch, level is wired to frame, and frame is wired to level. Since the output of stage 2 carries its frame number to the corresponding level input in stage 3, and since there are only 4 frames, there are only 4 inputs in stage 3. For example: frame 3 level 0 switch 9 of stage 2 is wired to the input of switch 9 level 3 in frame 0 and so on. The same pattern is followed on the other side of the network in stages 4, 5, and 6.

The Junctor Circuit

The junctor circuit, which connects stage 3 with stage 4, is perhaps the most complex circuit in the network. It performs most of the switching functions. A slip wiring arrangement is used between the junctors as shown on Figs. 3-4A, 3-4B, and 3-4C. Frames 0, 1, and 2 only are shown, but frames 3 through 9 follow a similar pattern.

The wiring connections between stage 3 and stage 4 can be worked out by following a formula which is described here and summarized in Table 3-1. In going from one stage to another, a level of any number in one stage connects to the level of the same number in the other stage. Similarly, a frame of any number in one stage connects with the frame of the same number in the next stage. But the switch number in one stage is not the same as the switch number in the next stage.

In going from stage 4 to stage 3, you add together the switch number and the level number in stage 4; then you add the frame number in stage 4. The

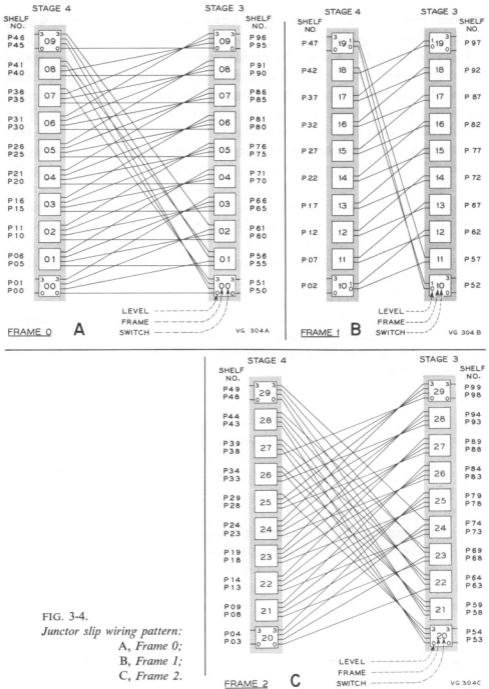

FIG. 3-4.
Juncior slip wiring pattern:
A, Frame 0;
B, Frame 1;
C, Frame 2.

sum of these quantities gives you the switch number in stage 3. (If this sum is greater than 9, subtract 10.)

For example, to go from frame 0, switch 6, level 3, of stage 4, you add the switch number and level number, $6+3$, getting 9; then you *add* the frame number, $0; 9+0=9$. This is the switch number in stage 3, namely: frame 0, switch 9, level 3, in stage 3.

In going from stage 3 to stage 4, you add the frame number and the level number in stage 3; then you *subtract* this total from the switch number in stage 3. This gives you the switch number in stage 4. (If the number should be negative, add 10.)

For example, to go from frame 2, switch 6, level 1, of stage 3, you add the frame number and level number, $2+1$, getting 3; then you *subtract* this total from the switch number, $6; 6-3=3$. This is the switch number in stage 4, namely: frame 2, switch 3, level 1, in stage 4.

The procedures are summarized in Table 3-1.

TABLE 3-1. FORMULA FOR JUNCTOR SLIP PATTERN

LEVEL-TO-LEVEL CONNECTIONS	
Any level in stage 4 connects to the level of the same number in stage 3.	
FRAME-TO-FRAME CONNECTIONS	
Any frame in stage 4 connects to the frame of the same number in stage 3.	
SWITCH-TO-SWITCH CONNECTIONS	
Going from stage 4 to stage 3	Add together the level number and switch number in stage 4. Then <i>add</i> the frame number in stage 4. The result is the switch number in stage 3. (If this number is more than 9, subtract 10.)
Going from stage 3 to stage 4	Add together the level number and frame number in stage 3. <i>Subtract</i> this total from the switch number in stage 3. The result is the switch number in stage 4. (If this number is negative, add 10.)

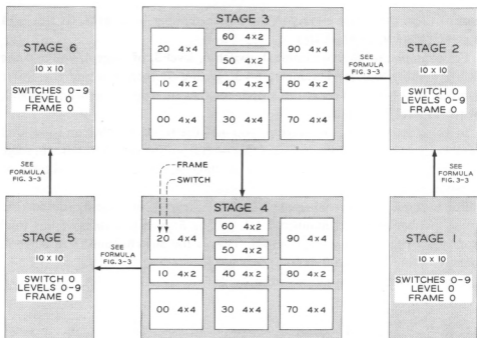

FIG. 3-5. Distribution switching network, wiring pattern.

VG 306

Wiring Arrangement of the Distribution Switching Network

A block diagram of the wiring arrangement of the distribution switching network is shown in Fig. 3-5. Vertical wiring connects stages 1 and 2, and stages 5 and 6. Stage 2 is wired horizontally to stage 3, and stage 4 is wired horizontally to stage 5. Stages 3 and 4 are wired together vertically. Only switch 0 in frames 0 through 9 in both stages 3 and 4 is shown. From the formula in Fig. 3-3, we learned that in the wiring between stages 2 and 3, switch is wired to switch, level is wired to frame, and frame is wired to level. With this arrangement, levels 0 through 9 of switch 0 in frame 0, are wired horizontally to the switch modules 0 in stage 3. Switches 1 through 9 in frames 0 through 9 follow the same pattern. Some of the stage 3 and stage 4 switches are 4-by-4, and some are 4-by-2. In stage 3, switches 0 in frames 0 through 9, contain 30 junctors; and as there are 10 sets there is a maximum of 300 junctors. For the Morris ESS, however, only 200 junctors are required for the distribution switching network with 400 terminals on each side.

3.2 CONCENTRATION SWITCHING NETWORK

The concentration switching network is a one-stage network. It is used to concentrate traffic from customer lines, on a ratio of 4 to 1. Traffic from forty customers is switched on to ten trunks. This provides a smaller number of trunk circuits with higher usage. An important consideration in network layout is to use the apparatus as heavily as possible.

A 40-by-10 concentration switch is shown on Fig. 3-6. This figure shows how forty customers have access to ten concentrator trunks to the distribution switching network. Each customer line has its individual line circuit. The gas diode crosspoints are shown by an X. We see that the first eight customers have access to six concentrator trunks, namely: trunks 0, 1, and 3 on the A side and trunks 5, 6, and 8 on the B side of the distribution switching network. With a slip multiple wiring, the next eight customers have access to concentrator

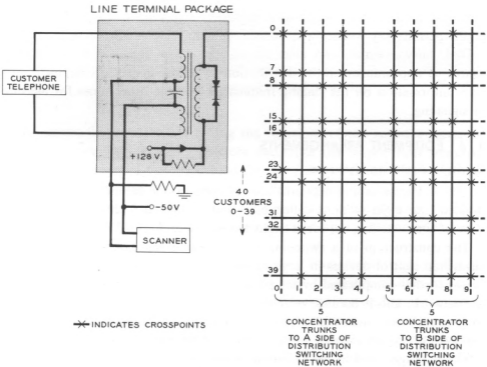

FIG. 3-6. Concentration switching network, 40-by-10 switch.

trunks 0, 2, 3, and 5, 7, 8. Fig. 3-6 shows the pattern for the five groups of customers. Normally, calls are handled so that the calling customer is connected to either the A side or the B side of the distribution switching network, and the called customer to the opposite side. Should blocking occur at any stage, the order of connections may be reversed, or the order may be modified in a search for idle paths.

3.3 SIGNAL SWITCHING NETWORK

The signal switching network is a one-stage network containing ten 60-by-10 switches. The switches are located in the switching network cabinet in bay 2 between the concentration and the distribution switches. The outputs of the ringing switches are evenly distributed on the A and B sides of the distribution switching network. They provide the tone ringer frequencies to ring the called customer, and the audible ringing tone to the calling customer. Two ringing trunks are used on each ringing connection. The inputs to the ringing switches are wired to the ringing frequencies, voice announcements, and audible and miscellaneous tone supplies. A multiple arrangement of gas diode crosspoints permits any frequency or tone to be connected to any trunk.

Dial, busy, reorder, and alert tones have direct appearances from their source to appearances on the distribution switching network. Chapter 1 provides information on the ringing frequencies and the other tones for alerting or signaling.

3.4 EQUIPMENT ARRANGEMENTS

3.4.1 *Switching Networks*

The switching networks are enclosed in one cabinet. The cabinet is divided into eight sections called bays and numbered 0 through 7. A front view of the switching networks cabinet is shown in Fig. 3-7.

The construction of a switching network using gas diode crosspoints and electronic control devices in large numbers was a major equipment problem. It was further complicated by the possibility of crosstalk between paths within the network. This is because switching is done with one conductor, unbalanced to ground, rather than with a pair of conductors. As a result, the wiring is in the form of spaced grids of wires, or shielded wiring.

The packages used in the switching networks are summarized in Table 3-2, on page 74.

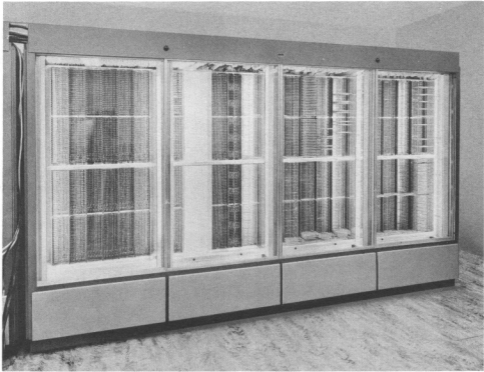
FIG. 3-7. *Switching networks cabinet, front view.*

VG 308

The electronic packages controlling the functions of the network (such as the propagators, links, enablers, junctors, and input and output trunk terminal packages) are mounted directly behind the gas diode switches. This keeps the wiring leads short. The office concentrator line terminal package is shown in Fig. 3-8. There are two circuits on a package. This is the package through which the customer gains access to the concentrator trunks. A junctor package is shown in Fig. 3-9.

The gas diode crosspoints are mounted on small frameworks called modules; one such module is shown in Fig. 3-10, on page 75. Each module has two inputs and ten outputs. Five of these modules stacked one on top of the other make a 10-by-10 switch. A schematic of the 2-by-10 crosspoint module is shown in Fig. 3-11. We can see how the two inputs have access to any of the ten outputs through the gas diode crosspoints. Using this arrangement, all the switches in one stage can be stacked on top of each other. The outputs from each switch

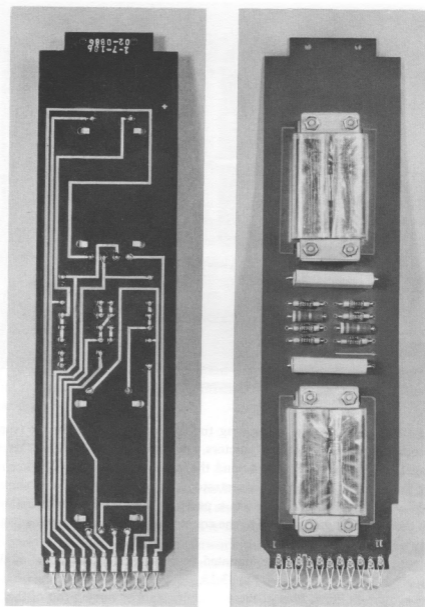

REAR

TWO CIRCUITS PER PACKAGE

FRONT

VG 309

FIG. 3-8. Office concentrator line terminal package.

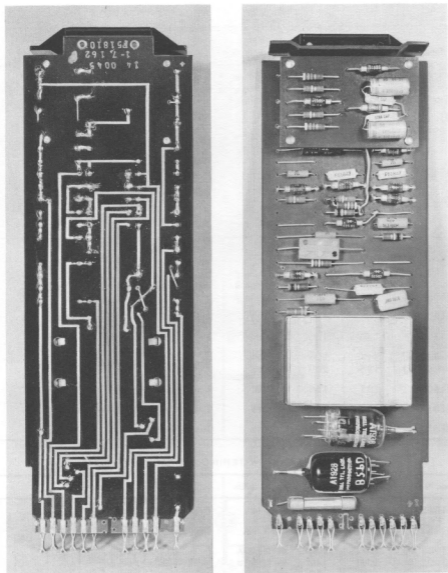

REAR

FRONT

VG 310

ONE CIRCUIT PER PACKAGE

FIG. 3-9. Junction package.

TABLE 3-2. PACKAGES USED IN THE SWITCHING NETWORKS

CONCENTRATION SWITCHING NETWORK				
F-Spec. Number	CPS* No.	Quantity	Abbreviation	Name
F-51899	101	500	LINE TERM	Office Concentrator Line Terminal Package
F-51849 (A)	111	250	X PT	Concentrator Crosspoint Modules
F-51984 (B)	112	250	X PT	
F-51850	121	56	TRK ENAB	Trunk Enabler Package
F-51851	122	56	RLS SEL	Release Selector Package
F-51900	102	140	TRK TERM	Concentrator Trunk Terminal Package
DISTRIBUTION SWITCHING NETWORK				
F-Spec. Number	CPS* No.	Quantity	Abbreviation	Name
F-51805	103	190	TRK TERM A	Trunk Terminal Packages
F-51896	104	14	TRK TERM B	
F-51897	106	162	TRK TERM D	
F-51806	113	400	X PT	Crosspoint Module (Stages 1 or 6)
F-51807	130	400	PROP	Propagator Package
F-51809 (A)	114	200	X PT	Crosspoint Modules (Stages 2 or 5)
F-51985 (B)	115	200	X PT	
F-51808	131	160	LINK	Link Package
F-51811	116	250	X PT	Crosspoint Module (Stages 3 or 4)
F-51810	132	200	JCTR	Junctor Package
SIGNAL SWITCHING NETWORK				
F-Spec. Number	CPS* No.	Quantity	Abbreviation	Name
F-51852	117	45	X PT	Crosspoint Module
F-51853	123	45	LINE SEL	Line Selector Output Package
F-51901 (A)	107	200	IN TERM A	Input Terminal Packages
F-51902 (B)	108	40	IN TERM B	
F-53038 (C)	110	30	IN TERM C	
F-51850	121	18	TRK ENAB	Trunk Enabler Package
F-51855	124	18	RLS SEL	Trunk Release Selector Package
F-51934	109	45	TRK TERM	Trunk Terminal Package

*CPS means Circuit Package Schematic.

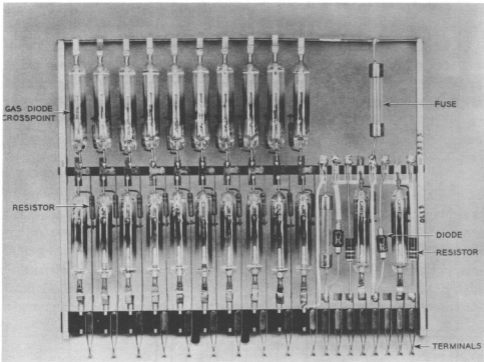

FIG. 3-10. Crosspoint module.

VG 311

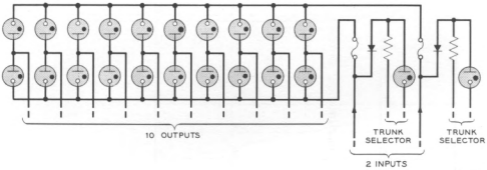
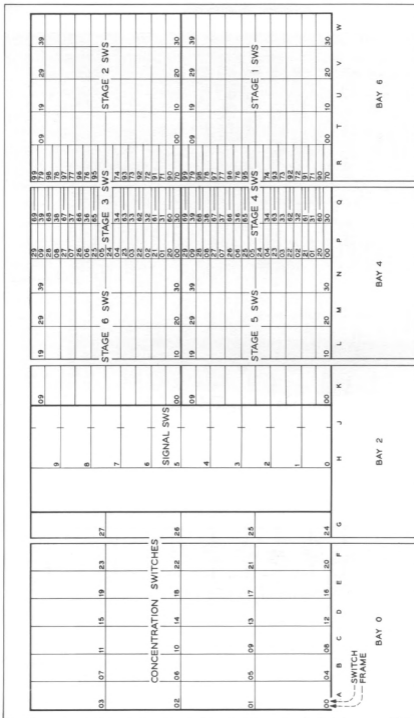

FIG. 3-11. 2-by-10 crosspoint module.

VG 312



VG 313

FIG. 3-12. Switching networks cabinet, front equipment.

are wired from one stage to another with tape wiring. This tape wiring consists of ten parallel conductors, with a ground lead between every two conductors to minimize crosstalk.

The switches in the cabinet are arranged in vertical columns. The columns are designated A to W, left to right, as indicated on Fig. 3-12. The concentration switches occupy columns A to G, the signal switches columns H and J, and the distribution switches columns K to W. The three types of switches are different in size. As shown, there are four concentration switches per column, ten signal switches in two columns, and twenty distribution switches per column.

In the switching networks, the external connections to the packages are made on terminal boards located across the top of the cabinet as shown in Fig. 3-13. Local cabling makes the connections from the underside of these terminals to the connectors of the various circuit packages within the cabinet. Input and output leads of the packages on the terminal board at the top of each bay are located thus: "TS" means terminal strip, this being one row of terminals running from the front to the rear of the cabinet. They are numbered from left to right. The numbers are stenciled on the terminal boards. "TERM" refers to an indi-

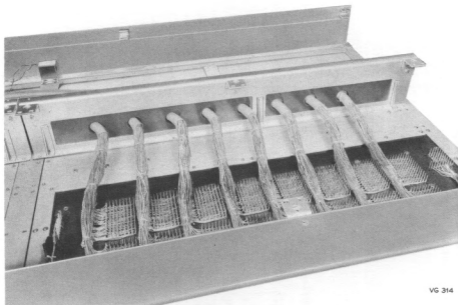
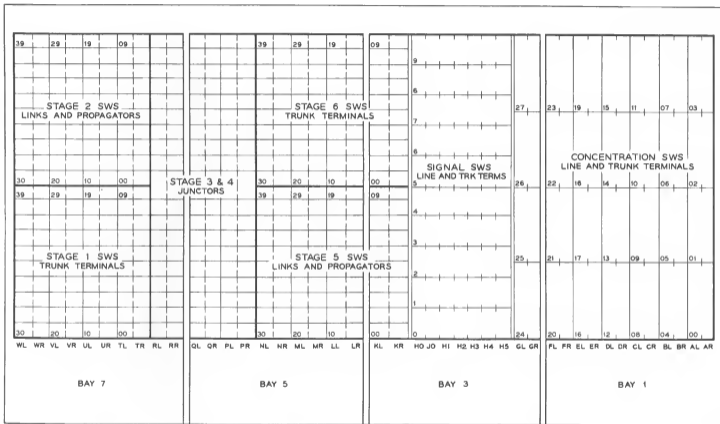

FIG. 3-13. *External wiring to switching networks cabinet.*

FIG. 3-14. *Switching networks cabinet, rear equipment.*

vidual terminal on a terminal strip. These terminal numbers are also stenciled on the terminal boards, with the lowest number toward the front of the cabinet.

To locate a particular package within the switching networks, refer to Fig. 3-14. This sketch shows the rear equipment of the switching networks cabinet. Here each switch frame from A to W is divided again into two columns. For example, Column A is divided into two columns stenciled AL (left) and AR (right). In the signal switching network, frame H has six columns stenciled

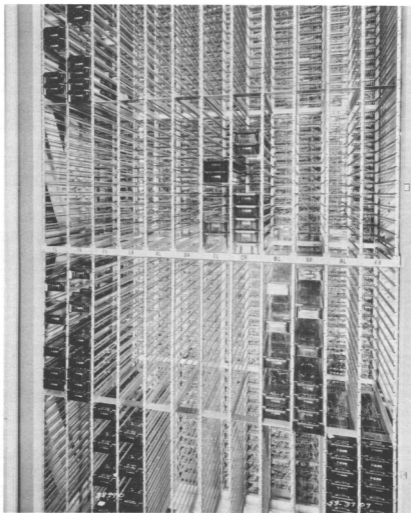

FIG. 3-15. *Switching networks cabinet, rear view.*

VG 316

TABLE 3-3. TYPICAL ASSIGNMENT OF TRUNKS ON THE DISTRIBUTION SWITCHING NETWORK

Name of Trunk	Code*	Number of Trunks			Signal Distributor Points	Scan Points	T3 Spots†
		Single-Ended A Side	Single-Ended B Side	Double-Ended			
Concentrator	1	135	135	—	—	—	—
Incoming from No. 5 Crossbar (Local and EAS Tandem)	8	31	—	8	39	39	—
Incoming from No. 5 Crossbar (Dialed Toll Tandem)	9	20	—	5	25	25	—
Outgoing to No. 5 Crossbar (Local)	10	—	31	8	39	39	✓
Outgoing to No. 5 Crossbar (EAS Tandem)	30	—	17	4	21	21	✓
Customer Group Service (CGS) Tie Lines	32	—	—	3	3	3	✓
Outgoing to 3CL Switchboard (Zero Operator and Recording-Completing)	12	—	9	4	13	13	✓
Outgoing to 3CL Switchboard (Perm. Sig.)	13	—	2	1	3	3	✓
Outgoing to 3CL Switchboard (Part. Dial)	14	—	2	1	3	3	✓
Outgoing to 3CL Switchboard (Den. Serv.)	15	—	3	1	4	4	✓
Outgoing to 3CL Switchboard (Repair and Business Office Night Transfer)	33	—	2	—	2	2	✓
Incoming from 3CL Switchboard (No Test)	16	—	—	1	1	1	—
Incoming from Test Cabinet	17	—	—	2	2	2	—
Outgoing to Test Cabinet	34	—	2	—	2	2	✓
Outgoing to 7A Information Desk	18	—	3	2	5	5	✓
Outgoing to 7A Intercept Desk	19	—	9	1	10	10	✓
Three-Line Conference Circuit	5	—	—	7 x 3	21	—	✓
Indicator Signal Trunk	20	—	—	5	15	—	✓
CGS Tone Signal Points (Alert Tone)	22	3	3	—	—	—	✓
Order Announcement	6	—	—	3	—	—	✓
Normal Ringing	3	—	—	15	—	—	✓
Skew Ringing	4	8 x 2	8 x 2	—	—	—	✓
Half-Second Ringing	28	—	—	2	—	—	✓
Dial Tone	23	3	7	—	—	—	✓
Busy Tone	24	2	5	—	—	—	✓
Re-Order Tone Points	25	1	3	—	—	—	✓
Toll Termination	26	5	5	—	—	—	✓
PBX Toll Tie Line	36	—	—	1	2	1	—
Network Noise Test Trunk	37	—	—	1	—	—	—

*This code identifies the location of the trunk on the distribution switching network.

†A check mark (✓) in this column indicates trunks or trunk groups that have network selector addresses in the flying spot store, and busy-idle spots in the barrier grid store.

H0 to H5; frame J has one column stenciled J0. The distribution switching network has two package columns stenciled L and R as in the concentration switching network.

A typical package location might be AR24. This is the package in the socket position slot stenciled 24 of the equipment frame stenciled AR in the rear of the cabinet. Fig. 3-15 is a rear view of the concentration switching network showing the stenciling and the packages inserted into the sockets. The package connector sockets are numbered from 1 to 11, left to right, looking from the rear. These numbers are molded into the socket.

The assignment of trunks on the distribution switching network is shown on Table 3-3. Listed are the numbers of single-ended A side trunks, single-ended B side trunks, and double-ended trunks in each trunk group. Table 3-3 also lists the number of scan points and signal distributor points for each trunk group. Trunk groups that have hunting lists (network selector addresses in the flying spot store, and busy-idle spots in the barrier grid store) are indicated by a check mark in the column headed "T3 Spots."

Each trunk group is given an arbitrary code, also shown in Table 3-3. This code identifies the location of the trunk on the distribution switching network. A double-ended trunk is assigned to the corresponding terminals on the A and B sides of the distribution network. The trunk termination circuits for any two trunks terminating on the same network module are mounted on a single plug-in package. Trunks of any given trunk group are spread over the network.

3 . 4 . 2 *Distributing Frames*

Main Distributing Frame (MDF)

A portion of the main distributing frame in the No. 5 crossbar office is reserved for the ESS. To conform with the No. 5 crossbar office practice, the terminal strips with the ESS equipment numbers are also located on the horizontal side of the main frame. Cross connections from the ESS equipment are run to the customer cable and pair in the usual manner. In the ESS the customer is assigned to input terminals on the MDF. These input terminals are designated with the switch and terminal number on which they terminate in the concentration switching network.

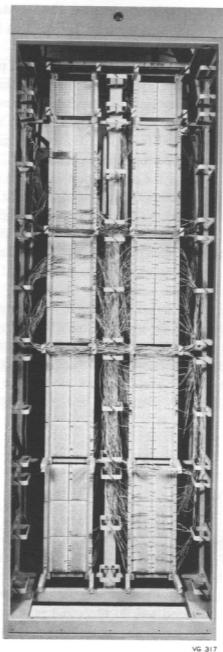

FIG. 3-16. *Trunk distributor.*

Trunk Distributor (TD)

The inputs and outputs of the switching networks are cabled to the TD, as shown in Fig. 3-16. These cables terminate on 8-by-20 wire-wrapped terminal blocks. The inputs and outputs of the distribution switching network are split into two verticals stenciled the A side and the B side, respectively. The stenciling locates the forty switches and their ten terminals on each side. The signal switching network and concentration switching network are also stenciled with the switch and terminal numbers. The scan points for the trunk and customer line circuits are not cross-connected but are wired direct. A few scan points, however, are terminated on the TD and cross-connected to the markers for test points. Cross-connections permit flexibility in assigning the concentrator trunks and signaling trunks in the distribution switching network. The trunks, such as incoming and outgoing to the No. 5 crossbar office, 3CL switchboard, etc., have an appearance on the TD and are cross-connected to the distribution switching network.

3 . 5 METHOD OF OPERATION

3 . 5 . 1 *Establishing a Talking and Signaling Path in the Concentration Switching Network*

Figure 3-17 shows one customer on a concentrator switch terminating on an office concentrator line terminal package. He has access, through gas diode crosspoints, to six concentrator trunks. Three of these concentrator trunks have appearances on the A side and three on the B side of the distribution switching network. Paths are established in the concentration switching network by various controlling circuits in the concentration marker.

On a customer service call, either originating or terminating, the line selector in the concentration marker receives an eleven-bit binary number from the central control. It translates this number into a two-digit address, one a positive and the other a negative pulse. These pulses permit the line selector gas diode A, associated with the customer line terminal address, to ionize. The selector verifier informs the central control that the right line selector gas diode has fired. When the gas diode A fires,* it raises the anode voltage of the gas diodes B from an idle condition of +128 volts to a potential of +171 volts.

*The word "fires" in this connection means "ionizes and conducts."

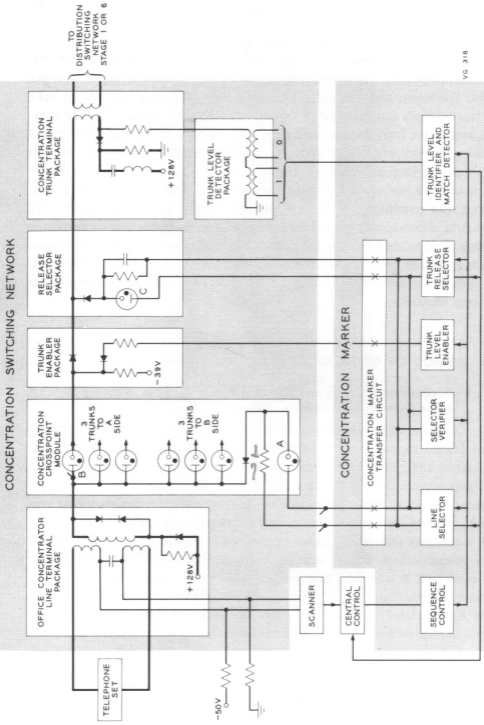

VG 318

FIG. 3-17. Talking and signaling path through the concentration switching network.

The trunk-level enabler sequentially supplies a negative 39-volt pulse to each of the three trunks on either the A or B side appearance as ordered by the central control. This pulse appears simultaneously with the pulse from the line selector on the gas diode B to the idle trunk; the gas diode B fires. The trunk-level detector receives a surge of this current and sends it to the trunk-level identifier and match detector. This informs the central control of the level, or input, in the distribution switching network, of the concentrator trunk selected. The trunk-level identifier notifies the sequence control to stop all operations and to turn off the trunk enabler and line selector. The holding path for this connection is from the + 128 volts in the concentrator line terminal through the gas diode crosspoint B to ground at the trunk-level detector. The talking and signaling path to the customer through the concentration switching network is shown by the heavy lines on Fig. 3-17.

The release of the path through the concentration switching network is as follows. The line terminal address is relayed to the central control via the scanner when the customer hangs up. The central control sends a trace order, or pulse, via the line selector through the trunk-level identifier to identify the trunk level of the concentrator trunk in the distribution switching network. The central control then gives a release order, or pulse, to the trunk release selector. This sends a negative and a positive pulse to fire the correct trunk release selector gas diode C. This causes the gas diode B to deionize and break the holding path. The path through the concentration switching network is now released.

3 . 5 . 2 *Establishing a Talking and Signaling Path in the Distribution Switching Network*

The talking and signaling path through one half of the distribution switching network is shown by the heavy line on Fig. 3-18. The path through the other half is similar. Connections are set up through the distribution switching network by applying a mark (changing the voltage) to the trunk terminals on each side between which a transmission path is desired. This change of voltage is propagated through the network from each side toward the junctor on all idle paths. At the junctor, only one of many paths is permitted to connect itself to the hold supply. Connections are set up in the distribution switching network by the central control via the distribution marker.

All trunks, such as concentrator, ringing, or outgoing trunks to the No. 5 crossbar office and 3CL switchboard, have appearances on the distribution

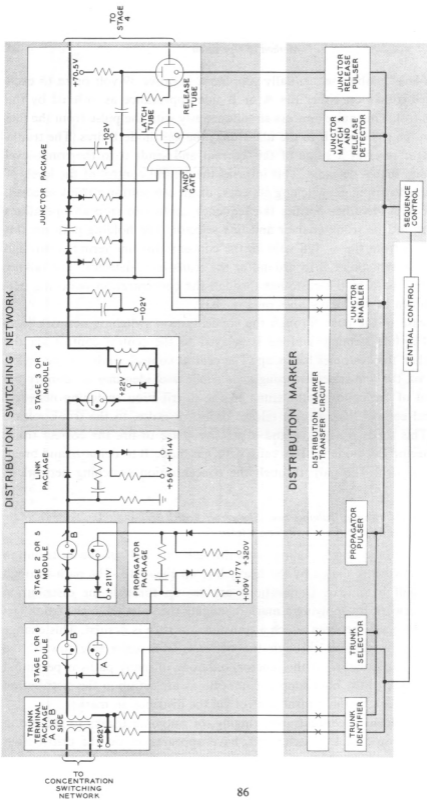

VG 319

FIG. 3-18. Talking and signaling path through the distribution switching network.

switching network. They also have terminal addresses so that the central control may, via the stored memory and the marker, select them. Ringing and concentrator trunks must have appearances on both the A and the B sides of the distribution switching network. The reason for this is so that a calling or called customer may be directed to either side. All trunk connections can be set up only through the network from the A to the B or from the B to the A side. For ringing trunk connections, two complete paths are set up through the distribution switching network. The ringing trunk is connected between the calling and called customer as shown in Fig. 3-19, on page 88. A talking connection between two customers is shown in Fig. 3-20.

Referring back to Fig. 3-18, let's see how a connection is set up through the distribution switching network. The central control passes a nine-bit binary number to the trunk selector. This in turn sends a positive and a negative pulse, respectively, to the anode and cathode of the trunk selector diode A, causing it to fire. When A fires, it applies a mark (change of voltage) to the selected trunk terminal. This mark is also sent to the trunk identifier which notifies the central control which trunk has been selected. At the same time a trunk is also selected on the opposite side of the network in the same manner. The mark voltage, supplied by the firing of gas diode A, raises the anode voltage of the first-and sixth-stage crosspoints B from an idle voltage of +276 volts to a potential of +317 volts. On a fully equipped idle network, a mark on one trunk terminal will ionize ten first-stage gas diodes. Each of these will ionize ten second-stage gas diodes, in turn ionizing two or four third-stage gas diodes, thus making a total of 200 or 400. Propagators are inserted in the links between the first and second, and between the fifth and sixth stages. The propagators furnish the additional fan-out current to fire the diodes in the intermediate stages.

The junctor enabler conditions the junctors, one at a time. A junctor must receive a mark from each side of the network, as well as an enable pulse from the junctor enabler, before it can connect to the hold supply. This combination of three pulses allows the latch tube in the junctor to fire and conduct. The holding path through the distribution switching network is from the +262 volts on the A and B side trunk terminals, through the gas diode crosspoints, and through the junctor latch tube to -205 volts in the junctor match-and-release detector.

On a release order from the central control, the sequence control in the distribution marker turns on the junctor release pulser. The trunk selector is ener-

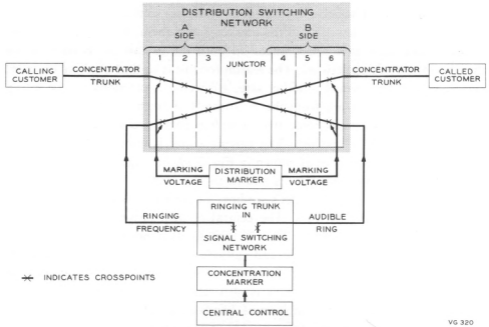

FIG. 3-19. Ringing trunk connection.

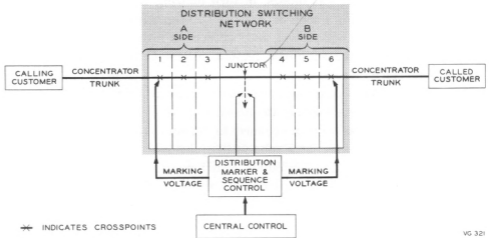

FIG. 3-20. Talking connection.

gized, which fires the gas diode A of the selected trunk. This pulse passes through the three conducting gas diode crosspoint tubes. The selector pulse, in combination with the junctor release pulse, fires the junctor release tube in the junctor. This removes the current from the latch tube. No holding path now exists for the A and B side termination, and the connection is released. With this arrangement, a release pulse on only one trunk terminal causes the entire connection through the distribution switching network to release.

3 . 5 . 3 *Establishing a Signaling Path in the Signal Switching Network*

A 12-by-2 ringing module in the signal switching network is shown in Fig. 3-21. Each module has twelve inputs and two outputs. Five modules make up one 60-by-10 switch. The ten ringing trunks are evenly distributed on the A and B sides of the distribution switching network. The figure shows trunk 0 with an A and B appearance. Trunks assigned as skew ringing trunks have both outputs assigned to only one side of the distribution switching network. The eight ringing frequencies, audible ring, and miscellaneous tones are the inputs to the module. The ringing frequencies connect to the trunk through operated crosspoints. The ringing trunk has leads to the trunk-level enabler, trunk release selector, and trunk-level identifier. Paths are set up in the signal switching network by the line selectors in the concentration marker.

For example, let's connect a called customer to a ringing frequency on the B side of the distribution switching network. The line selector in the concentration marker receives a binary address from the central control. It in turn sends a positive and a negative pulse to fire the line selector gas diode A. A mark voltage now appears on the gas diode crosspoint B. The trunk-level enabler C applies a negative pulse to the idle ringing trunk selected by the central control. This pulse with the mark voltage from the line selector causes the gas diode B to fire. The holding and signaling path is from the +128 volts, through the gas diode crosspoint B, to ground in the trunk-level identifier. The ringing frequency is induced, through transformers, to the B side appearance of the trunk. The called customer is connected to it through the distribution switching network. Audible ringing tone is then connected to the calling customer on the A side of the distribution switching network. The audible ringing tone is selected via the line selector gas diode E, gas diode crosspoint F, and trunk-level enabler G. This holding and signaling path is from the +128 volts, through the gas diode crosspoint F, to ground in the trunk-level identifier H.

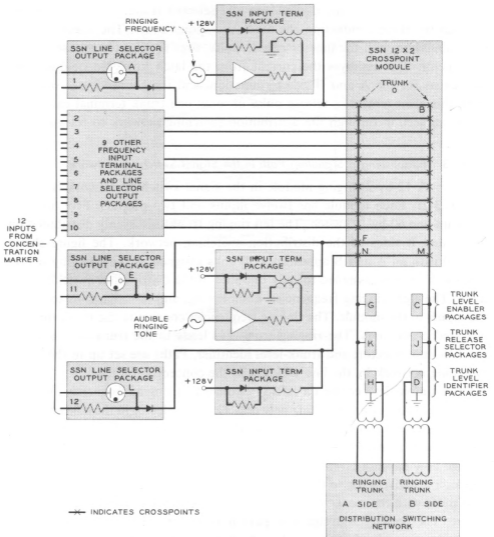

FIG. 3-21. Signaling path through ringing switch.

VG 322

On a release order from the central control, a pulse from the trunk release selector J causes the gas diode B to deionize and break the connection on the ringing side. A release pulse on the audible ringing side from the trunk release selector K causes the gas diode F to deionize and break its connection.

3.6 POWER

3.6.1 *Power Requirements*

All the power required by the switching networks is supplied by direct current. This power may be sustained for long periods or applied in pulses. The power supplies for the switching networks and the markers occupy the same cabinets. This power is supplied by regulated and unregulated rectifiers operating from a 230-volt, 60-cycle, single-phase, continuous a-c source. For reliability in the d-c supply, all the rectifiers are furnished in duplicate. Some of the d-c outputs are connected in parallel but are powered from separate a-c buses. The concentration and distribution switching networks are powered from different supplies. The switching network cabinets contain only the 1½ volt rectifiers. All other power is supplied directly from the power cabinets through fuses at the base of the switching network cabinets.

Some rectifiers have their d-c outputs connected in series with both terminals above ground potential. This is called stacking supplies. An assembly of stacked supplies is called a composite power supply. The use of composite power supplies is illustrated by Fig. 3-23. For example, positive potentials of 276 volts and 262 volts are required. By adding the auxiliary +14-volt rectifier to the +262-volt supply we obtain a +276-volt supply. This system of stacking is considerably cheaper than providing a separate rectifier for each voltage needed.

3.6.2 *Power Equipment*

A schematic diagram of part of the rectifiers and outputs used also is shown on Fig. 3-23. Here we see the +262 volts 0 and 1 feeding a common bus bar through the switches S4-0 and S4-1 on the control panel. The manual switches are shown in the open position, but with the system in operation all these switches are closed. Certain packages in the network require a voltage present at all times; any interruption may destroy the package. For this reason, the +262 volts is further supplemented by a battery reserve, on switch 12. If for some reason switches S4-0 and S4-1 are turned off, or if the a-c supply to both rectifiers should fail, the +262 volts is still maintained to the switching networks.

The reserve batteries are nickel cadmium; and, since they float across the rectifier outputs, they are at full charge all the time. No maintenance is required.

Some outputs are not connected in parallel but are individual from each rectifier, such as the +276 volts 0 and 1. Failure of one of these rectifiers will

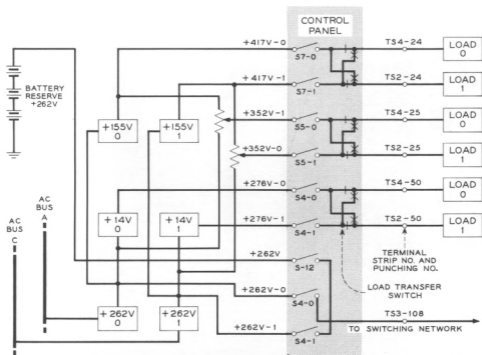
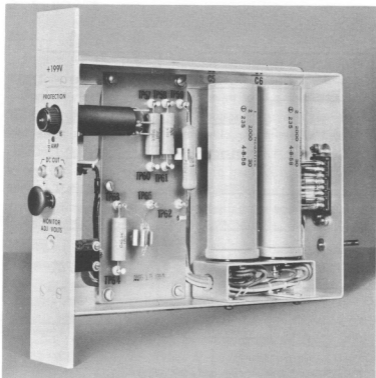

FIG. 3-23. Power supplies and their outputs.

VG 324

not affect service, because the duplicate load that is served by a different rectifier will still function. However, if a rectifier, and a marker not associated with it, should fail, service is restored by the manual load transfer switch on the panel. This transfers the good rectifier output to the good marker.

Extensive use of voltage dividers is possible in this power arrangement. A voltage divider is simply a resistor with taps, connected across a power supply output. The voltage at each tap then depends on the amount of resistance across the circuit or the voltage drop: You can see in Fig. 3-23 how the use of voltage dividers makes it possible to obtain a +352 volts. These outputs are also through the panel switches and load transfer switch. A voltage divider is shown in Fig. 3-24 and Fig. 3-25. Those rectifiers having their outputs connected in parallel do not go through the load transfer switch. Diodes in the rectifier outputs prevent reverse battery from the other rectifier in case of failure.

FIG. 3-24. *Voltage divider.*

VG 325

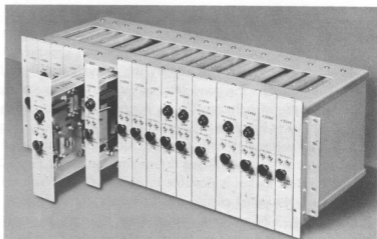
FIG. 3-25. *Voltage divider assembly.*

VG 326

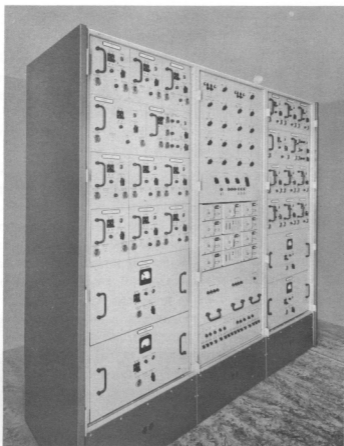
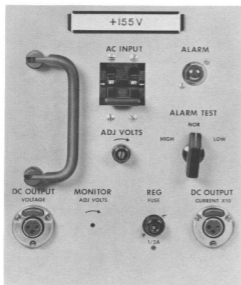

FIG. 3-26. *Power cabinets for distribution switching network and distribution markers 0 and 1; front view.*

VG 327

Power Cabinets for Distribution Switching Network and Distribution Markers

The power supplies for the distribution switching network and the distribution markers are shown in Fig. 3-26. These cabinets are designated NP-0 (Network Power-0). The cabinet bay numbers are stenciled on the metal framework above the appliance outlets (not shown on the photograph). The two end cabinets are identical. The center cabinet is the control cabinet. Each end cabinet contains thirteen regulated rectifiers. Their outputs are wired to the



VG 328

FIG. 3-27.
Individual power supply, front view.

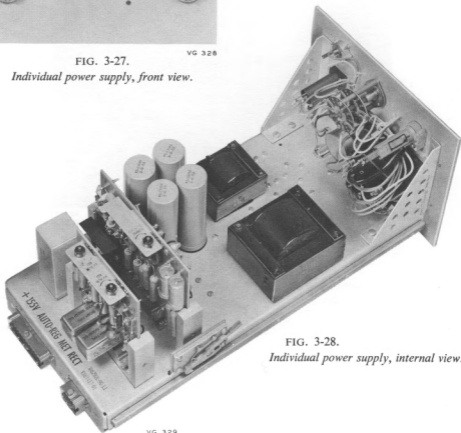

FIG. 3-28.
Individual power supply, internal view.

VG 329

center control cabinet, and then distributed to the distribution switching network and distribution markers. The rectifiers can be removed from the cabinets by disconnecting the input and output plugs in the rear, loosening the retaining bolt, and sliding the unit out the front.

A rectifier is shown in Fig. 3-27 and Fig. 3-28. A detailed sketch of the control cabinet is shown on Fig. 3-29, on page 98. At the upper left and right hand corner of the control panel are the switches for the a-c circuit breakers. The switch marked DIST in the upper left corner controls the a-c to the rectifiers in the left cabinet, and the DIST switch on the right controls the a-c to the right cabinet.

The NET CON switch on the left controls the a-c to the first five rectifiers just below the control panel, and the NET CON switch on the right controls the a-c to the next five rectifiers. The first five rectifiers supply group 0 or distribution marker 0, and the next five supply distribution marker 1.

The panel switches control the outputs of the stacked rectifiers, and the voltages are stenciled above the switch. In the test position, a test load is placed on the outputs for measuring and adjusting the individual supplies. When the power is turned on, the switches must be turned to the normal position, beginning at the top and following the sequence shown by the arrows. When removing a rectifier from service, the switches are returned to the test position in reverse order. This holds for both groups 0 and 1.

Directly below these switches are the switches for the battery reserve, load transfer switch, alarm switches for each cabinet, and the 48-volt d-c supply for each cabinet.

Below the ten rectifiers mentioned previously we see the battery reserve panels. Pin jacks are provided for voltage measurements. The bottom panel in the cabinet contains the voltage dividers, each stenciled with the output voltage and the jacks for voltage measurements.

Each rectifier has a high-voltage and a low-voltage alarm. A high-voltage alarm trips the circuit breaker for that rectifier. This is a visual alarm on the rectifier and the center control panel. The alarm is also given at the administration center. A low-voltage alarm does not trip the circuit breaker but it does give an alarm. There is an alarm test switch in each rectifier to simulate a high or low voltage. This lights the alarm lamp in the rectifier unit but does not give an alarm at the administration center. The output voltage of each rectifier is periodically monitored by the system.

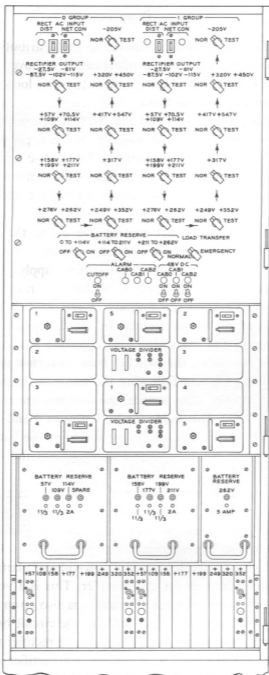

FIG. 3-29. Power panel for distribution switching network and distribution markers 0 and 1; front equipment.

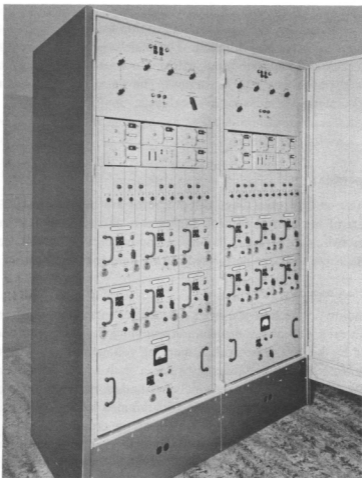

FIG. 3-30. Power cabinets for concentration network, signal switching network, and concentration markers 0 and 1; front view.

*Power Cabinets for Concentration and Signaling Switching Networks,
and Concentration Markers*

The power cabinets for the concentration and signaling switching networks and for the concentration markers are shown on Fig. 3-30. These cabinets are designated CP-0. Each cabinet contains five low-voltage nonregulated rectifiers, seven regulated rectifiers, and fourteen voltage dividers.

The cabinet on the left with the load transfer switch is the main distributing cabinet. The cabinet on the right has its outputs wired to the cabinet on the left. These are also stacked supplies. The panel switches perform the same function as those in the distribution switching network power cabinets and the sequence followed as shown by the arrows. The alarm system is also the same. There are no reserve batteries in these cabinets.

3.7 MAINTENANCE

Testing and trouble diagnosis programs are built into the ESS as an integral part of the central control. Included in these are several tests of the distribution switching network, namely, a "no-connection" and a "low-break-down" test. These tests are performed during light load periods.

3.7.1 *No-Connection Test*

The no-connection test works in this manner. One input and output terminal on each side of the distribution switching network, and one junctor, are selected by the central control. A marking voltage placed on the terminals, and an enable pulse on the junctor causes a path to be set up through the network. By selecting a known terminal and junctor, each gas diode crosspoint is tested for breakdown. This test is programmed by the system from test information in the flying spot store. To test all the crosspoints in the network, each terminal of each switch is tested ten times, and each junctor twenty times.

When a no-connection occurs, the system causes the information to be printed out by the teletypewriter at the administration center. By taking the typed information and referring to the "dictionary," the actual path and packages in the network that failed can be determined. If a crosspoint in a selected path is busy, a no-connection test read-out will occur. The test is made twice at intervals of one half hour. One read-out on a particular no-connection test is ignored as it assumed that on one of the tests the path was busy. One tenth of the network is tested each night.

A typical typed read-out might be ▲SNRT HBT 399 891. The symbol ▲ indicates a trouble report. SNRT means a switching network routine test, and HBT indicates that it is a high breakdown test (no-connection). The first three digits (399) give the terminal number used, and 891 is the junctor number.

3 . 7 . 2 Low-Breakdown Test

The low-breakdown test determines whether the gas diode crosspoints fire on less voltage than specified. Such an action can cause false connections and releases. The low-breakdown test requires a series of twelve tests during the time when the test connection called for in the no-connection test is held. It checks a specific gas diode crosspoint for low-breakdown into the already established path. A failure is typed out at the administration center. Reference is made to the dictionary to determine the location of the failure.

Chapter 4

Concentration and Distribution Markers

There are two markers in the ESS—the Concentration Marker (CM) and the Distribution Marker (DM). The name “marker” comes from the operation of *marking* terminals in the switching networks. The marking is done by applying voltage pulses on the terminals between which a transmission path is to be connected.

The CM and DM, as a team, set up and take down all connections in the switching networks. The marker operations are under the direction of the central control. The markers may be thought of as robots, since they do not know whether the connections being set up or released are a part of a dial tone path, a ringing path, or a talking path.

On receipt of a connect or release order from the central control, the markers translate the address into an equipment location in the switching networks. After the markers have acted upon the network terminal, they translate its equipment location back into the original address form, and return it to the central control for verification.

The CM and DM are furnished in duplicate. Because all four markers are electrically independent of each other, they can be used in any paired combination of one CM and one DM. While one pair is in service, the other pair is in stand-by condition. The stand-by pair is continuously performing self-checking operations which insure that it is trouble-free and ready for service. If an in-service marker develops any trouble, a signal is sent to the system via the scanner. On receiving such a trouble report, the ESS arranges to switch into service a stand-by marker.

The cabinet line-up of the markers and their associated networks is shown in Fig. 4-1. From left to right, the first two cabinets contain the two concentration markers, which are designated CM-0 and CM-1. The third and fourth cabinets, which are designated DM-0 and DM-1, contain the two distribution markers. The other cabinets shown in this view contain switching networks.

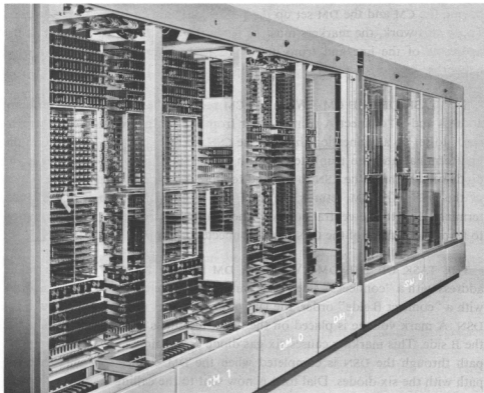

FIG. 4-1. Marker cabinets, front view.

4 . 1 INTRODUCTION TO THE CM AND DM OPERATIONS

Perhaps the best way to introduce you to the CM and DM operations is to describe their functions in setting up a typical call. An intraoffice call is selected for this purpose and is briefly described in this section. The sections following this one will describe in more detail the CM and DM operations.

4 . 1 . 1 Dial Tone Connections

Establishing a Connection

When a customer originates a call, the scanner notifies the ESS of the off-hook condition. The ESS arranges to have dial tone connected to the line, by

having the CM and the DM set up the needed paths in the switching networks. To do this work, the markers must be given the connect orders as well as the addresses of the line and trunk terminals to be connected in the switching networks.

THE TASK OF THE CM—When the CM receives the customer line terminal address and a “connect A trunk” order from the central control, the CM proceeds to set up a connection through the CSN. A mark voltage is placed on the line terminal and the trunk terminal in the CSN. This marking causes a gas diode crosspoint in the CSN to fire and to close a path to a trunk on the A side of the DSN. The CM returns the CSN line terminal location and the trunk terminal level to the central control. The central control uses this information to form the address of the CSN trunk connected to the A side of the DSN.

THE TASK OF THE DM—When the DM receives the CSN trunk terminal address with a “connect A side” order and the dial tone trunk terminal address with a “connect B side” order, the DM proceeds to set up the path through the DSN. A mark voltage is placed on the trunk terminals on both the A side and the B side. This marking causes six gas diode crosspoints in the DSN to fire. A path through the DSN is completed when the DM connects a junctor in the path with the six diodes. Dial tone is now sent to the calling customer through these seven crosspoints in the switching networks.

Releasing a Connection

When the customer starts to dial, the scanner detects the change in the line condition and notifies the ESS. The ESS arranges to have the dial tone removed from the line. The CSN path is not released at this time, since it is needed later in the call, for the ringing and the talking connections. The DM, on receipt of the dial tone trunk terminal address and a “release B side” order, proceeds to release the DSN path. A release mark voltage is placed on the trunk terminal. This causes a pulse to be sent through the three gas diodes forming this part of the dial tone connection. This pulse, in combination with the junctor release pulse, causes the release of the entire connection in the DSN, thus removing the dial tone. The identity of the dial tone trunk appears in the DM and is passed to the central control.

4.1.2 *The Ringing Connections*

After the calling customer has dialed seven digits, the ringing connections are set up. There are two stages in this operation, namely: (1), connecting audible ringing tone to the calling customer; and (2), connecting tone-ringing current to the called line.

Connection for Audible Ringing Tone

In connecting the audible ringing tone, the central control obtains the address of an idle audible ringing trunk in the signal switching network (SSN). It passes this information to the CM, which sets up a connection from the SSN to a trunk on the B side of the DSN. The equipment location of this trunk is identified by the CM and passed to the central control. When the central control receives the equipment location, it passes this information to the DM, which proceeds to set up the connection in the DSN. The calling customer now receives audible ringing tone.

Connection for Tone-Ringing Current

To set up the ringing connection to the called line, the central control passes "connect" orders to the CM and DM. The markers set up the connections for tone-ringing current through the CSN and DSN. Tone ringing is thus connected to the called line.

4.1.3 *The Called Customer Answers*

After the called customer answers, the central control passes to the CM and DM orders to release the ringing connections. The calling customer connection in the CSN is not released, however.

When the "release" orders have been carried out, the central control passes the "connect" orders for setting up the talking connection. The conversation between the two customers can now proceed.

4.1.4 *Disconnect*

When either the calling customer or the called customer hangs up, the ESS detects this change in condition. The central control passes "release" orders to the CM and DM to release the talking connection.

This completes the marker operations involved in setting up and releasing an intraoffice call.

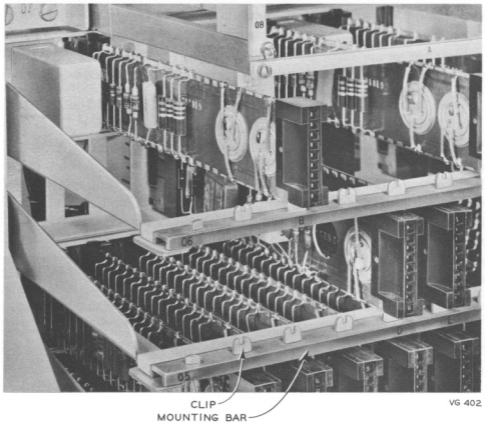

FIG. 4-2. Mounting arrangements for the 1½-inch packages.

4.2 EQUIPMENT ARRANGEMENTS

4.2.1 Apparatus Elements

Each marker consists of many small circuits interconnected in patterns to perform desired functions. The small apparatus and components in these circuits are packaged on printed-wiring boards. The markers use two sizes of such packages, as listed below:

- (1) A 1½-inch package is used for all transistor and miscellaneous circuitry. The method of mounting such packages is shown in Fig. 4-2, and described below.

- (2) A 7-inch package is used for ferrite core matrices and gas-diode circuitry. The mounting arrangement for such packages is shown in Fig. 4-3, and described below.

Other items of marker apparatus whose size makes it impracticable to mount in packages are shown in Fig. 4-4.

4 . 2 . 2 Apparatus Mounting Arrangements—Figs 4-2 and 4-3

Various mounting arrangements are used in the markers. Two of the methods used are shown in Figs. 4-2 and 4-3.

The 1½-inch packages are mounted vertically on their long edges and are plugged into connectors. The packages are aligned and supported by a bar and a clip on the end opposite to the connectors, as shown in Fig. 4-2. The connectors are mounted into mounting plates and are spaced at intervals of either ¾ inch or 1 inch along the plate.

The 7-inch packages are mounted horizontally in vertical columns that consist of horizontal shelves and guides. Fig. 4-3, in a view looking upward, shows how they are arranged. The packages are plugged into rigid wire terminals located on the shelves. Two edge guides and a center guide provide alignment for the mating of the terminals on a package with the terminals on its shelf. These guides also serve to hold the plate securely in position.

The transformers, relays, terminal strips, and other pieces of apparatus not mounted as packages (some examples are shown in Fig. 4-4) are secured to mounting plates.

4 . 2 . 3 Cabinet Layout of the Concentration Marker

Front View (Fig. 4-5, page 110) and Front Equipment (Fig. 4-6, page 111)

The apparatus layout is the same for both the upper and lower parts of the cabinet. Therefore, only the upper apparatus layout is described.

The upper half of the cabinet consists of seven mounting plates for the 1½-inch packages. The plates are numbered bottom to top, on the left frame up-right. Each mounting plate has space for mounting twenty-eight 1½-inch packages. The plate positions are lettered left to right, A to Y, and AA to AF, omitting I, O, S, and Z.

Directly below these seven mounting plates are four vertical columns. Each column has a capacity of twelve 7-inch packages mounted horizontally. The shelves are numbered bottom to top. The columns are lettered left to right.

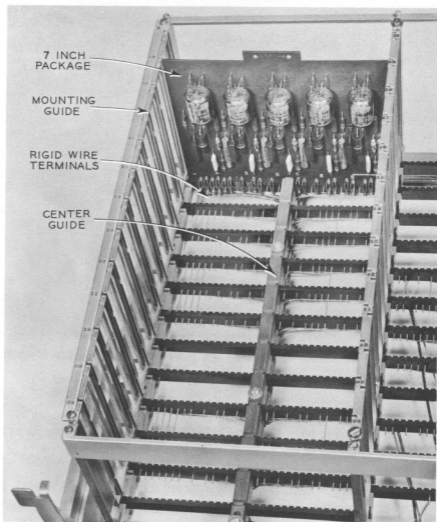

FIG. 4-3. Mounting arrangements for the 7-inch packages, seen from below.

The power cut-in relays in the power interrupter circuit (door interlocks) are mounted on the bottom inside panel of the cabinet. This panel is hinged to allow access to the wiring side and the voltage filter panel located behind it. The wire-spring relays switch all power of 350 volt-amperes or less. The power relays switch all power greater than this.

The bottom front cabinet panel, beneath the sliding door, is hinged to allow access to the fuses.

The relays in the marker transfer circuit are mounted on the framework between the pair of markers. These relays connect the markers to the CSN.

The two concentration markers contain identical pieces of apparatus. But in order that the circuits in each marker be electrically the same as the circuits in its mate, the apparatus layout of marker 1 is reversed; that is, it is a mirror image of marker 0. Therefore, corresponding pieces of apparatus do not have the same location designations. For example, the apparatus in mounting plate position B in marker 0 will be in mounting plate position AE in marker 1.

The layout of the circuits in the front portion of the cabinet is shown in Fig. 4-6, on page 111.

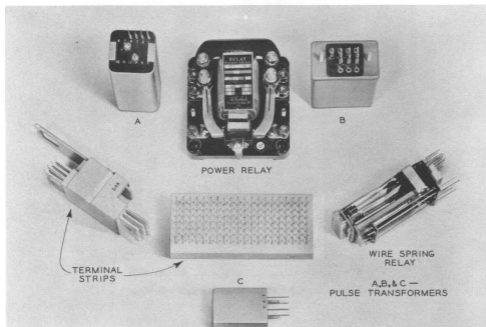

FIG. 4-4. *Miscellaneous marker apparatus.*

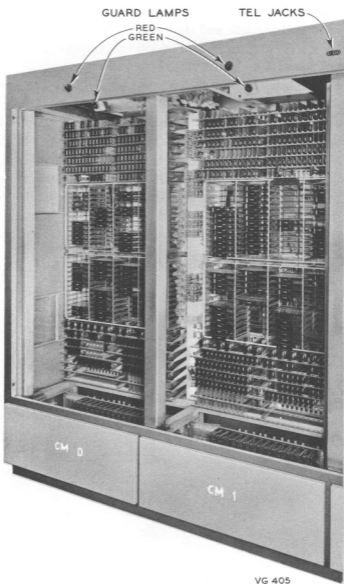

FIG. 4-5. Concentration marker, front view.

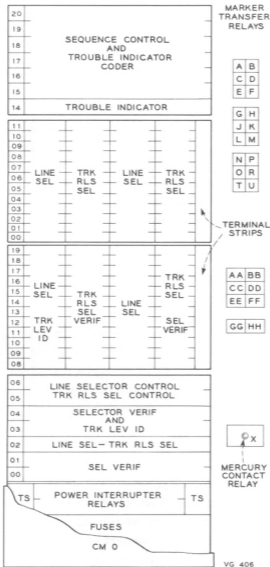

FIG. 4-6. Concentration marker, front equipment.

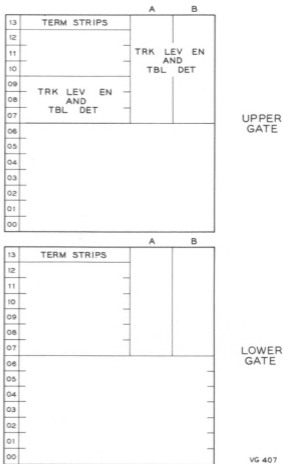

FIG. 4-7. Concentration marker, rear equipment.

Rear Equipment (Fig. 4-7)

The rear equipment is mounted on an upper and a lower hinged gate, as shown in Fig. 4-7. This arrangement allows easy access to the wiring side of the equipment. The mounting arrangement of the top and bottom gates are the same. Therefore, only the top gate arrangement is described.

There are fourteen mounting plates. Terminal strips are mounted on the top plate, and the 1½-inch packages are mounted on the other thirteen plates. The plates are numbered bottom to top. The bottom seven plates extend across the width of the gate. The top seven plates are half-length plates. There are

two vertical columns to the right of those seven half-length plates. The 7-inch packages are mounted horizontally in those columns.

4.2.4 Cabinet Layout of the Distribution Marker

Front View (Fig. 4-8, page 114) and Front Equipment (Fig. 4-9, page 115)

The apparatus in the upper half of the cabinet controls the A side of the distribution switching network (DSN). The apparatus in the lower half of the cabinet controls the B side of the DSN. The apparatus layout in the upper part is the same as the layout in the lower part. Therefore, only the upper apparatus layout is described.

The upper half of the cabinet consists of four vertical columns. Each column has a capacity of twelve 7-inch packages mounted horizontally. The shelves are numbered from bottom to top. The columns are lettered left to right.

Directly below these four columns are seven mounting plates for 1½-inch packages. The plates are numbered from bottom to top, on the left frame upright. Each mounting plate has space for mounting twenty-eight 1½-inch packages. The plate positions are lettered left to right, A to Y, and AA to AF, omitting I, O, S, and Z.

The power cut-in relays in the power interrupter circuit (door interlocks) are mounted on the bottom inside panel of the cabinet. This panel is hinged to allow access to the wiring side and the voltage filter panel located behind it. The wire-spring relays switch all power of 350 volt-amperes or less. The power relays switch all power greater than this.

The bottom front cabinet panel, beneath the sliding door, is hinged to allow access to the fuses.

The relays in the marker transfer circuit are mounted on the framework between the pair of markers. These relays connect the markers to the DSN.

The two distribution markers contain identical pieces of apparatus. But, in order that the circuits within each marker be electrically the same (as to wire length, capacities, etc.), the apparatus layout of marker 1 is reversed. Marker 1 is a mirror image of marker 0. Therefore, corresponding pieces of apparatus do not have the same location markings. For example, the apparatus in mounting plate position B in marker 0 will be in mounting plate position AE in marker 1.

The layout of the circuits in the front portion of the cabinet is shown in Fig. 4-9, on page 115.

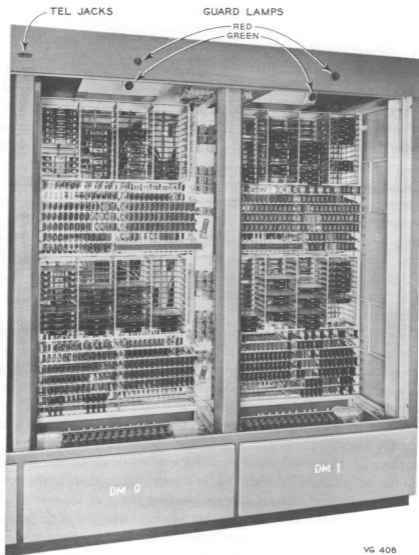
FIG. 4-8. *Distribution marker, front view.*

VG 408

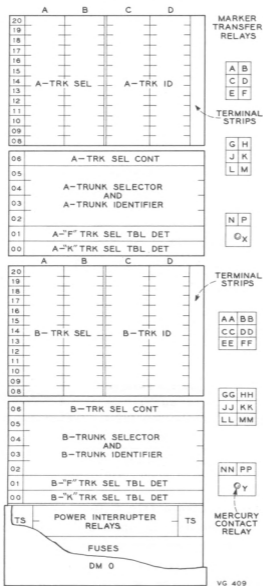

FIG. 4-9. Distribution marker, front equipment.

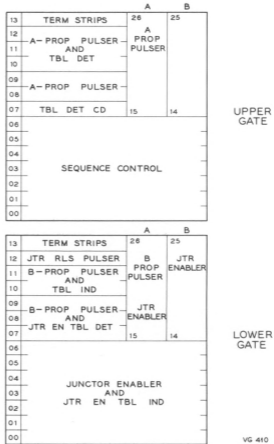

FIG. 4-10. Distribution marker, rear equipment.

Rear Equipment (Fig. 4-10)

The rear equipment is mounted on an upper and a lower hinged gate, as shown in Fig. 4-10. This arrangement permits easy access to the wiring side of the equipment. The equipment layout of the top and bottom gates are the same. Therefore, only the layout of the top gate is described.

There are fourteen mounting plates for the 1½-inch packages. The plates are numbered bottom to top. The bottom seven plates extend across the full width of the gate. The top seven plates are half-length plates. There are two vertical columns to the right of the seven half-length plates. The 7-inch packages are mounted horizontally in these columns.

4.2.5 Cabinet Doors and Gates

Door interlocks are provided on the rear gates and on the front sliding doors of all markers. When a door or gate on an in-service marker is opened, a signal is sent to the central control. An open door or gate on a stand-by marker shuts off the power. A "door open" report is recorded on the teletypewriter at the administration center.

4.2.6 Power Supply Cabinets

The power cabinets are used jointly by the switching networks and the markers. Chapter 3, *Switching Networks*, covers the operation and use of these power supplies.

4.3 METHOD OF OPERATION OF THE CONCENTRATION MARKER

The concentration marker (CM) controls the connections through the concentration switching network (CSN) and the signal switching network (SSN). The connections through these two networks are covered in Chapter 3, *Switching Networks*.

4.3.1 Network Orders

The concentration marker operations described in this section are based on the network orders received from the central control. These orders are: "connect"; "release"; "clear"; "trace"; "override busy"; and "reset". The marker handles such network orders in a basic operational sequence as follows:

- (1) The marker receives a network order from the central control.
- (2) Returns a check signal to the central control indicating receipt of an order.
- (3) Completes the order work in the switching networks.
- (4) Returns an "operation successful" signal to the central control.
- (5) Returns an "operation ended" signal to the central control.
- (6) Returns a signal indicating whether the network terminal is idle or busy.

- (7) Receives a "reset" order (clear out) when the central control recognizes the "operation ended" signal. This order resets all marker circuits that returned to the central control all such information as "operation successful," "operation ended," "busy," etc. The marker does not return a signal to indicate receipt of the "reset" order. The "reset" order is sent in advance of all orders except the "clear" order.

Typical switching network orders required by the marker when setting up a normal connection between two customers are shown in Table 4-1.

TABLE 4-1. TYPICAL SWITCHING NETWORK ORDERS TO THE MARKERS

Call Sequence	Orders to Markers
Customer starts call	<p>(Scanner detects the off-hook condition). <i>Connect order and line address to CM.</i> <i>Connect orders and trunk addresses to DM, to give dial tone to calling customer.</i></p>
First dial pulse	<p>No action in CM. <i>Release order and trunk address to DM, to take down dial-tone connection in DSN.</i></p>
Called customer number translated by ESS	<p><i>Connect order and ringing tone terminal address in SSN to CM.</i> <i>Connect orders and trunk terminal addresses in DSN to DM, for ringing tone connection.</i> <i>Connect order and audible ringing terminal address in SSN to CM.</i> <i>Connect orders and trunk terminal addresses in DSN to DM, for audible ringing connection.</i></p>
Called customer answers	<p><i>Release order and ringing tone terminal address in SSN to CM.</i> <i>Release orders and trunk terminal address in DSN to DM (for ringing tone connection).</i> <i>Release order and audible ringing terminal address in SSN to CM.</i> <i>Release order and trunk terminal address in DSN to DM (for audible ringing connection).</i> <i>Connect order and outgoing trunk terminal address in DSN to DM, to set up a talking path between the customers.</i></p>
Operation successful in setting up talking path through network	<p>No further operations required until the customers hang up.</p>

4.3.2 Functions of CM Circuits (Fig. 4-11)

The major units within the CM are shown in Fig. 4-11, on page 120, and their functions are listed in Table 4-2 below.

TABLE 4-2. FUNCTIONS OF THE CIRCUITS IN THE CM

Name of Circuit	Function of Circuit
Line Selector Verifier	Returns the customer line equipment location in the switching network to the central control.
Line Selector	Marks the customer line network equipment location in the switching network.
Line Selector Control	Controls the operating sequence of the line selector and line selector verifier.
Trunk Level Enabler	Marks idle trunks between the CSN and the DSN
Trunk Release Selector	Marks the trunk equipment location to be released.
Trunk Release Selector Control	Controls the operating sequence of the trunk release selector
Trunk Level Identifier and Match Detector	Detects when the customer line is connected to an idle trunk, and identifies the equipment location of the trunk.
Trouble Detector Coder	Returns detected marker trouble to the scanner.
Sequence Control*	Furnishes pulses in sequence to the marker circuits, to set up and take down network connections.
CONNECTING CIRCUITS	
Marker Transfer	The relays in this circuit switch the network leads to either marker 0 or marker 1.
Stand-By Transfer	The relays in this circuit switch the central control leads to either marker 0 or marker 1.

*The sequence control is the key circuit of the CM.

4.3.3 Sequence Control, 0 or 1 Marker (Fig. 4-11)

The concentration marker (CM) sequence control, on receipt of a network order, furnishes pulses to control the various circuits within the marker. These pulses tell the circuits when to set up connections in the CSN and SSN, and when to release them.

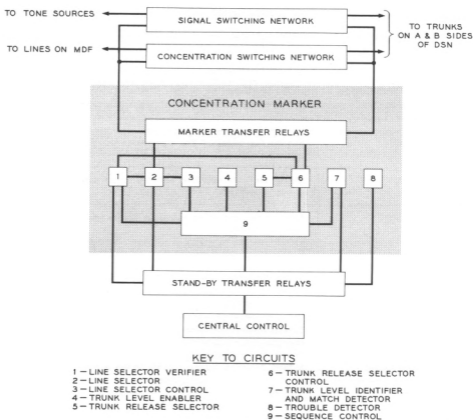

FIG. 4-11. Concentration marker, block diagram.

VG 411

The speed with which the circuits in the switching network will operate is much slower than that of the circuits in the central control. The sequence control can, however, accept the high-speed signals (network orders) from the central control. It passes them at a slower rate of speed to the marker circuits that control the switching networks.

After leaving an order with the marker, the central control continues its work with other system programmed tasks. The system program arranges periodically for the central control to check the progress of the marker in setting up the CSN connections. When the central control recognizes the "operation ended" signal, it sends the next order for continuing the path through the CSN.

The sequence control may be considered, for the purpose of illustration, as consisting of a number of circuits each having its own input from the central control. Also, for this purpose, it may be considered that all the circuits use the same four common outputs to the central control.

The inputs (orders) to the sequence control are:

- (1) Connect A trunk (i.e., a trunk to the A side of the DSN).
- (2) Connect B trunk (i.e., a trunk to the B side of the DSN).
- (3) Trace.
- (4) Release.
- (5) Override busy.
- (6) Clear.
- (7) Reset.

The outputs from the sequence control that report the progress of the marker to the central control are:

- (1) Check (indicates the receipt of an order).
- (2) Operation successful.
- (3) Busy.
- (4) Operation ended.

In order that you may understand the operation of the sequence control, each type of order it serves is described separately.

“Connect A Trunk” Order—Line-to-Trunk Connection

The first order described is a “connect A trunk” order: i.e., a line-to-trunk connection in the CSN. This order enables a path to be set up from a customer line through the CSN to a trunk leading to the A side of the DSN. It is assumed that the central control has passed the binary address of the customer line to the line selector, and the “connect A” order to the sequence control. The line selector will translate the binary address into a terminal equipment location in the CSN, on receipt of a signal from the line selector control which is under command of the sequence control. Before describing how the sequence control handles this “connect” order, one more job remains to be done. That is to reset the sequence control flip-flops that are used to indicate “operation ended,”

“operation successful,” etc., to the central control. This resetting is done by sending a “reset” order in advance of each order, excepting the “clear” order.

The “connect” order sequence of operations is as follows:

- (1) The central control sends a positive voltage on the “connect A” input lead to start the sequence control.
- (2) A check (CK) signal is returned to the central control, indicating receipt of the order. The central control, on receiving the CK signal, removes the “connect” order input voltage. No change in the sequence control takes place.
- (3) The 2-millisecond timer is started (the “connect” order time-out).
- (4) The 250-microsecond timer is started (the busy-test time-out).
- (5) A voltage pulse is sent to the trunk level identifier and match detector circuit, and to the line selector verifier control circuit, to clear out these circuits.
- (6) The line selector control is started. This circuit controls the operation of the line selector. The line selector translates the binary address, which it received from the central control, into the line terminal equipment location in the CSN. The selector then causes a marking voltage to be placed on the selected line terminal.
- (7) If a busy condition exists, a surge current operates an amplifier in the CSN trunk level detector.

A single pulse then operates gates in the sequence control. This sets the busy flip-flop and starts an “internal clear” sequence.

The trunk level identifier operates and identifies the trunk level to which the busy line is connected. The trunk level is coded into binary form and returned to the central control.

- (8) If the customer line is not busy, the sequence control recognizes this condition, since it will not receive a busy signal during the busy-test timing interval.
- (9) The 250-microsecond busy-test timer resets.
- (10) The trunk enabler circuits are started.

The line selector verifier monitors the outputs of the line selector to obtain the translated line terminal equipment location. It translates

this information back into a binary address and returns it to the central control for verification.

The trunk level enabler marks in sequence the level of each of the five trunks in the A group to the DSN. The trunk level detector, in the CSN, recognizes when the line-to-trunk connection is completed, and informs the trunk level identifier and match detector. The trunk level identifier codes into binary form the trunk level on which the connection was completed, and returns this information to the central control.

- (11) A pulse from the trunk level identifier and match detector circuit causes the sequence control to return the "operation successful" signal to the central control.
- (12) The sequence control "internal clear" sequence is started.
- (13) The "operation ended" signal is returned to the central control.
- (14) The sequence control is now ready for the next order.

"Connect B Trunk" Order—Trunk-to-DSN Connection

This network order is identical with that for the A trunk. The sequence control may be considered as divided into three parts:

- (1) The equipment to serve side A.
- (2) The equipment to serve side B.
- (3) The equipment to serve both the A and the B sides.

"Trace" Order

The purpose of the "trace" order is to find out whether a connection exists from the line through the CSN, and if so, to what CSN trunk. The "trace" order is given before a "release" order. To illustrate, assume that the first customer hangs up. The line equipment number in the CSN is known by the central control. The trace operation applied to the line identifies the CSN trunk, and hence, the DSN connection. After these are determined, a "release" order is given to take down all the connections from this trunk side.

After the second customer hangs up, the line will not test busy because the connection has already been taken down. Thus, when the "trace" order is given by the central control, there will be no match trace pulse from the trunk level

identifier and match detector circuits within the busy-test interval. At the end of the timing interval, the "internal clear" sequence is started.

The sequence of operations for a "trace" order is as follows: A "reset" order is sent along with the "trace" order to reset the sequence control flip-flops that indicate "operation ended," "operation successful," etc., to the central control.

- (1) The central control sends a positive voltage on the trace input lead to start the sequence control.
- (2) A CK signal is returned to the central control indicating receipt of the order. The central control, on receiving the CK signal, removes the trace input voltage. No change in the sequence control takes place.
- (3) The 2-millisecond timer is started.
- (4) The 250-microsecond busy-test timing is started.
- (5) A voltage pulse is sent to the trunk level identifier and match detector circuit and to the line selector verifier to clear out these circuits.
- (6) The line selector control is started. This circuit controls the operation of the line selector. The line selector translates the binary address, which it received from the central control, into the line terminal equipment location in the CSN. The selector then causes a marking voltage to be placed on the selected line terminal.
- (7) During the busy-test timing interval, if a busy condition exists, the trunk level detector circuit in the CSN sends a pulse to the sequence control. The busy flip-flop is set and the "internal clear" sequence is started.

The trunk level identifier operates and codes the trunk level into binary form, and returns this information to the central control.

- (8) If no path exists through the terminal traced, a match pulse is not sent to the sequence control.
- (9) At the end of the busy-test timing interval, the timer is reset and the "internal clear" sequence is started.
- (10) On a "trace" order, the "operation successful" flip-flop is not involved, and the central control reads only the busy indication.
- (11) The "operation ended" signal is returned to the central control.

“Release” Order

When a path through the CSN is to be taken down because of a completed call or for some other reason, a “release” order is sent to the CM. The release is always made from the trunk side and never from the line side of the CSN.

A “reset” order is sent along with the “release” order to reset the sequence control flip-flops that indicate “operation ended,” “operation successful,” etc., to the central control. The sequence of operations for the “release” order is as follows:

- (1) The central control sends a positive voltage on the release input lead to the sequence control to start the circuit.
- (2) A CK signal is returned to the central control indicating receipt of the “release” order.
- (3) The central control, on receiving the CK signal, removes the release input voltage. No change in the sequence control takes place.
- (4) The 2-millisecond timer is started (the “release” order time-out).
- (5) A voltage pulse sent to the trunk release selector, causes it to clear out the line selector verifier circuit and the trunk level and match detector circuit.
- (6) The trunk release selector also causes a diode in the talking path of the line to be back-biased. This deionizes the gas diode tube, and thus opens the path through the crosspoint.
- (7) The resulting current change is detected in the trunk level identifier and match detector circuit. This causes a pulse to be sent to the sequence control to start:
 - (a) The “operation successful” signal to the central control.
 - (b) The sequence control “internal clear” sequence.
 - (c) The “operation ended” signal to the central control.

“Over-Ride Busy” Order with “Connect” Order

The necessity to use the “over-ride busy” order arises under special circumstances. Under ordinary operation, attempting to break into a busy path will cause a busy indication, and the sequence control will clear itself. By the use of the “over-ride busy” order, on “connect” orders, a special gate in the sequence control prevents clear out during the busy-test interval. Thus, a pulse

that comes because of a busy path cannot clear out the sequence control, and the trunk enabler is started. This sets up a new connection into the busy path.

The pulse that is received when the new connection is made, causes the setting of the "operation successful" flip-flop, and starts the "internal clear" sequence.

This order is used to set up a talking path through the SSN. A special SSN input terminal is provided for each ringing trunk. When this input terminal is connected to the two ends of the ringing trunk a "talking path" is set up between the two ends of the ringing trunk. The first connection between the input terminal and one end of the ringing trunk uses a standard "connect" order. The second connection between the input terminal and the other end of the ringing trunk requires the "over-ride busy" with a "connect" order.

"Clear" Order

A "clear" order is used for testing, or for analyzing trouble. The central control does not require the return of a check signal to indicate the receipt of this order. Unlike all other orders, a reset signal is not sent in advance of a "clear" order.

The "clear" order consists of a positive voltage from the central control. It resets the busy-test delay, and starts the "internal clear" sequence.

If an order is in progress in the sequence control, and the central control wishes to cancel that order, a "clear" order can be given to the sequence control. A "clear" order may also be given if the check (CK) output to the central control remains positive (because of some circuit fault) after the operation is ended.

"Internal Clear" Sequence

The "internal clear" sequence within the sequence control occurs under the following conditions:

- (1) When the marker has successfully completed its work in connection with a network order.
- (2) When the marker cannot complete its work within the time allowed (a time-out starts the "internal clear" sequence).
- (3) When the central control sends a "clear" order, as explained under *"Clear" Order*.

The operational sequence of clearing the sequence control, when it receives a "clear" order from the central control, is as follows:

- (1) The trunk level enabler is turned off.
- (2) The 2-millisecond timer is reset.
- (3) A 250-microsecond timer is started.
- (4) At the end of the 250-microsecond delay, the timer is reset.
- (5) The release voltages are removed from the anodes of the release and line selector gas tubes. Deionization of the gas tubes starts.
- (6) Another 250-microsecond timer starts.
- (7) At the end of the 250-microsecond delay, the timer is reset.
- (8) Normal voltage is restored on the anodes of the gas tubes in the release and line selectors.

The trunk and line identifier cores are read out.

- (9) The 50-microsecond timer is started. This delay insures that the identifier cores are properly set before the "operation ended" signal is returned to the central control.
- (10) The 50-microsecond timer is reset.
- (11) The "operation ended" signal is returned to the central control.
- (12) The sequence control is now ready for the next call.

4.3.4 Line Selector Control, 0 or 1 Marker (Fig. 4-11)

The line selector control consists of amplifiers, flip-flops, set gates, ferrite cores, and release pulsers.

The line selector control acts on signal orders received from the sequence control to operate and control the line selector. It sets and reads the vertical and horizontal translator cores, and turns on and off the memory amplifiers in the F and K sections of the line selectors.

4.3.5 Line Selector, 0 or 1 Marker (Fig. 4-11)

The line selector is used to mark the line terminal in the CSN or the tone source terminal in the SSN. To do this, the selector translates a coded

signal (a binary address) into a switch and terminal equipment location in the CSN or the SSN. The translation is made through a combination of positive and negative amplifiers, and core matrices. The selector is divided into two parts, F and K, with F and K input leads from the central control, and F and K output leads to the CSN and SSN. Signals through the F part of the selector determine the network switch location. Signals through the K part of the selector determine the terminal (level) within the network switch.

The central control sends a twelve-bit binary address over F and K leads to the selector. This address is translated within the selector into two output signals, F and K, to the network. These signals fire the gas diode crosspoint associated with the selected network terminals.

4.3.6 *Line Selector Verifier, 0 or 1 Marker (Fig. 4-11)*

The line selector verifier is used to monitor the line selector output leads to the network. It translates this network terminal equipment location back into a binary address, and returns it to the central control. The network terminal equipment location is received by the line selector verifier as a two-part input address, i.e., F and K. This address is passed through a combination of amplifiers, flip-flops, and translator core matrices. The translation provided by the verifier is passed as a twelve-bit binary address to the central control. The central control can compare this address with that of the line selector verifier in the stand-by CM. When a mismatch is recognized, the central control arranges to have it recorded by the teletypewriter at the administration center.

4.3.7 *Trunk Level Enabler, 0 or 1 Marker, (Fig. 4-11)*

The trunk level enabler marks the first idle trunk in the CSN to which the customer line has access. The enabler also serves the SSN in the same way, marking the first idle trunk to which the selected tone ringing or audible ringing tone circuit has access.

The trunk level enabler is under command of the sequence control. It consists of amplifiers, core matrices, delay circuits, and pulse amplifiers. It applies, in sequence, a negative pulse to each CSN trunk level in the A or B group. This negative pulse appears with the pulse from the line selector on the gas diode crosspoint to the idle trunk, firing the gas diode. The trunk level detector in the CSN receives a surge of this current and sends it to the trunk level identifier and match detector.

4.3.8 *Trunk Level Identifier and Match Detector, 0 or 1 Marker (Fig. 4-11)*

On receipt of a pulse from the trunk level detector, the trunk level identifier and match detector circuit recognizes that the customer line is matched to an idle trunk, after which it identifies the equipment level of the trunk.

The circuit consists of a combination of amplifiers, flip-flops, positive and negative identifier core matrices, and coupling and shunting networks. The trunk level translation that this circuit provides is passed to the central control as a binary address. This circuit also notifies the sequence control to stop all operations, and to turn off the trunk level enabler and line selector.

The talking and signaling path to the customer through the CSN is now complete. The path is held by a voltage through the gas diode crosspoint to ground at the trunk level detector in the CSN.

4.3.9 *Trunk Release Selector Control, 0 or 1 Marker (Fig. 4-11)*

The trunk release selector control is made up of amplifiers, flip-flops, setgates, and release pulsers.

The trunk release selector control circuit acts on orders from the sequence control to operate and control the trunk release selector. It sets and reads the cores, and turns on and off the memory amplifiers in the trunk release selector.

4.3.10 *Trunk Release Selector, 0 or 1 Marker (Fig. 4-11)*

The trunk release selector circuit starts the release of the connection in the CSN. The selector does this work upon orders from the sequence control.

The trunk release selector translates a coded signal (a binary address) into the trunk equipment location of the trunk to be disconnected. The translation is made through a combination of positive and negative amplifiers, and core matrices. The selector equipment is divided into two parts, F and K, with F and K input leads from the sequence control, and F and K output leads to the CSN and SSN. Signals through the F part of the selector determine the network switch location. Signals through the K part of the selector determine the terminal (level) within the network switch.

The trunk release selector receives a ten-bit binary address from the central control over the F and K leads. The input address is translated into two output signals. The two output signals are then passed to the network, as positive and negative outputs, over the F and K leads. This "disconnect" mark causes a back-bias to be placed on a diode in the talking path, thus deionizing the crosspoint diode. This results in the release of the SSN or the CSN connections.

4.4 METHOD OF OPERATION OF THE DISTRIBUTION MARKER

The distribution marker (DM) controls the connection and disconnection of the paths through the distribution switching network (DSN) under command of the central control. The DSN has trunks connected to both its A side and its B side. The connections through the DSN are covered in Chapter 3, *Switching Networks*.

The two principal jobs handled by the DM in connection with the distribution switching network are: (1), connections; and (2), disconnections.

The DM is also capable of reporting on the following:

- (1) Whether a busy condition exists on a network connection.
- (2) Whether the network operation was successful or unsuccessful.
- (3) Whether a trouble condition exists in the marker.
- (4) And when the marker work is finished (*operation ended*).

The DSN paths set up by the distribution marker are:

- (1) Dial tone.
- (2) Ringing.
- (3) Talking.
- (4) Other signals and tones such as busy, reorder, etc.

A path through the DSN is obtained by putting marking voltages on the equipment terminals between which a transmission path is requested by the central control. As a result of these marking voltages, several possible network paths are made available between the two marked terminals. However, only one of these paths is set up by enabling only one junctor at a time.

4.4.1 Functions of the DM circuits (Fig. 4-12)

The major units within the DM are shown in Fig. 4-12, on page 132, and their functions are listed in Table 4-3, opposite.

4.4.2 Sequence Control, 0 or 1 Marker (Fig. 4-12)

The sequence control circuit in the DM is similar to the sequence control circuit in the CM. However, in the following text no cross-referencing has been used, although many of the features and circuit operations are the same. The cross-referencing was omitted to provide continuity of reading.

TABLE 4-3. FUNCTIONS OF THE CIRCUITS IN THE DM

Name of Circuit	Function of Circuit
Trunk Identifiers, A or B	Return the trunk equipment location in the DSN to the central control.
Trunk Selector, A or B	Mark the trunk network equipment location in the A or B side of the DSN.
Trunk Selector Controls, A or B	Control the operational sequence of the trunk selectors.
Propagator Pulser, A or B	The A propagator pulser furnishes the fan-out current for the linkage between switching stages 1 and 2. Propagator pulser B similarly serves stages 5 and 6.
Juncor Enabler	Controls the completion of the path from the A to the B side of the network by selecting a juncor to connect the two halves of the network.
Juncor Release Pulser	Controls the release of the juncor path in the network.
Trouble Detector Coder	Returns troubles detected in the markers to the scanner.
Sequence Control*	Furnishes pulses required by the markers to set up and take down connections in the DSN.
CONNECTING CIRCUITS	
Marker Transfer	The relays in this circuit switch the network leads to either marker 0 or marker 1.
Stand-By Transfer	The relays in this circuit switch the central control leads to either marker 0 or marker 1.

*The sequence control is the key circuit of the DM.

The DM sequence control, on receipt of a network order, furnishes pulses to control the various DM circuits. These pulses cause the circuits to set up and release connections in the DSN.

The operating speed of the circuits in the DSN is in milliseconds, whereas the speed of the central control is in microseconds, a thousand times as fast. To match the slow speed of the DSN to the high speed of the central control, a sequence control circuit is used. The sequence control accepts the high-speed signals from the central control, and then passes them in sequence (and at a slower rate) to the marker circuits that control the DSN.

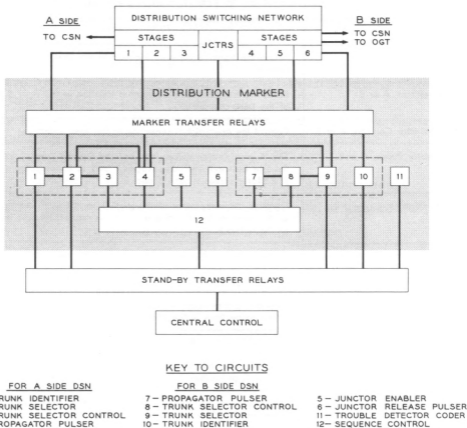
FIG. 4-12. *Distribution marker, block diagram.*

VG 412

After leaving an order with the marker, the central control continues its work with other system programmed tasks. The system program arranges periodically for the central control to check the progress of the marker in setting up the DSN connections. When the central control recognizes the "operation ended" signal, it sends the next order for continuing the path through the DSN. The answer signals from the marker permit the central control to follow the progress of the path through the DSN.

The sequence control may be considered, for the purpose of illustration, as consisting of a number of circuits each having its own input from the central

control. Also, for this purpose, it may be considered that all the circuits use the same four common outputs to the central control.

The inputs (orders) to the sequence control are:

- (1) Connect.
- (2) Release from the A side.
- (3) Release from the B side.
- (4) Connect for test.
- (5) Clear.
- (6) Reset.

The progress report returned to the central control covers three pieces of information:

- (1) The completion of an operation.
- (2) Its success or failure.
- (3) On unsuccessful connections, a progress report tells whether a failure was caused by encountering a busy terminal, or by failure to make a connection. This latter case may be caused by a fault in the system, or by the inability to find an idle path from an available junctor to the desired terminals (i.e., blocking).

To illustrate the operation of the sequence control, each type of order that it handles is described separately. The first order described is a "connect" order. This order enables a path to be set up from the A side of the DSN to the B side.

"A and B Side Connect" Order in DSN

Assume that the central control has passed a binary address to both the A and B trunk selectors. The trunk selectors will translate these addresses into trunk terminal equipment locations in the DSN, on receipt of a signal from the trunk selector control circuits. These control circuits are under command of the sequence control. Before the sequence control can handle the "connect" order, one other job remains to be done. That job is to reset the sequence control flip-flops that are used to indicate "operation ended," "operation successful," etc., to the central control. This resetting is done by sending a "reset" order in advance of each new order, excepting the "clear" order.

On receipt of the "connect" order, the sequence control sets the following marker circuits in operation:

- (1) A and B propagator pulser;
- (2) A and B trunk selector control; and
- (3) A and B trunk identifiers (to clear out the identifier cores).

A positive voltage on the CK check lead notifies the central control that the "connect" order has been received. The central control then removes the "connect" order input voltage. During the busy-test delay interval, the A and B trunk selector control circuits mark the end terminals of the trunk to be connected. If these trunk network terminals test busy, a surge current sent to the hold supply operates the junctor match and release detector circuit. This causes a pulse to be sent to the sequence control to start an "internal clear" sequence.

The junctor enabler is not started on a "connect" order when a trunk tests busy. The sequence control sends a positive voltage signal over the busy lead to the central control to indicate the busy trunk condition. At the end of the "internal clear" sequence, the sequence control sends a positive voltage signal to the central control over the OPE lead. At the end of this "operation ended" indication, the marker is ready for a new order.

When the trunk to be connected is not busy, and no idle path from a junctor to the selected trunk terminal is found, the busy-test delay interval passes. The busy-test delay is reset without a busy indication being sent by the junctor match and release detector circuit. The junctor enabler is started, since the sequence control received a "connect" order. However, at the end of the 20-millisecond time-out period, because the junctor enabler has not seized an idle junctor, an "internal clear" sequence is started in the sequence control. The sequence control returns the "operation ended" signal without an "operation successful" or a "busy" signal. The central control recognizes this condition as a block in the DSN. The DM is now ready for the next order.

When the trunk to be connected is not busy, and the junctor enabler has seized an idle junctor, the junctor latch tube (in the DSN) receives the mark voltages from both sides of the network; with the junctor enabler signal, it fires the tube. This completes the path through the DSN. A match pulse (from the junctor match and release detector in the DSN) is generated by the resulting holding current. It indicates the successful completion of the connection. The sequence control returns the "operation successful" and "operation ended" signals to the central control. The DM is now ready for the next order.

“Internal Clear” Order

The “internal clear” sequence within the sequence control occurs under the following conditions:

- (1) When the marker has successfully completed its work in connection with a network order.
- (2) When the marker can not complete its work within the time allowed (a time-out starts the “internal clear” sequence).
- (3) When the central control sends a “clear” order, as explained under “Clear” Order.

The “internal clear” sequences of operations within the sequence control, for a “connect” order and for a “release” order, are outlined below to show the circuits affected in each case.

“Internal Clear” Sequence for a “Connect” Order

- (1) The sequence control sends a pulse to the A and B trunk selector control circuits and the A and B propagator pulsers.
- (2) This starts the deionization of the gas triode tubes in the output of these circuits.
- (3) The 20-millisecond timer is reset.
- (4) The junctor enabler is turned off.
- (5) The 250-microsecond delay timer is started.
- (6) At the end of the 250-microsecond delay interval, the timer is reset.
- (7) A pulse is sent to the A and B propagator pulsers and the A and B trunk selector circuits to restore normal voltages.
- (8) The 50-microsecond delay timer is started.
- (9) At the end of this delay interval, a pulse is sent to the trunk identifiers.
- (10) This causes the A and B trunk identifier cores to be read.
- (11) The 15-microsecond timer is started to insure that the identifier cores are read out before the “operation ended” signal is sent to the central control.
- (12) At the end of this delay interval, this timer is reset.

- (13) A positive voltage signal is sent to the central control over the OPE lead to indicate "operation ended."
- (14) The sequence control is ready to receive the next order.

"Internal Clear" Sequence for a "Release" Order

- (1) The sequence control sends a pulse to the A and B trunk selector control circuits.
- (2) This starts the deionization of the gas triode tubes in the output of these circuits.
- (3) The 2-millisecond timer is reset (the "release" time-out).
- (4) The 250-microsecond delay timer is started.
- (5) The 250-microsecond timer times out.
- (6) A pulse is sent to stop the junctor release pulser.
- (7) A pulse is sent to the A and B trunk selectors to restore normal voltages.
- (8) The 50-microsecond timer is started.
- (9) At the end of this time interval, a pulse is sent to the A and B trunk identifiers.
- (10) The A and B trunk identifier cores are read.
- (11) The 1.5-millisecond timer is started.
- (12) The junctor release tube deionizes.
- (13) The 1.5-millisecond timer times out.
- (14) A pulse sets the "operation ended" flip-flops.
- (15) The sequence control is ready to receive the next order.

An over-all 30-millisecond time-out interval is provided. This timer is started upon receipt of an order. In the event that no voltage appears on the OPE "operation ended" lead before the end of this time-out interval, the order flip-flops will be cleared.

"Connect for a Test" Order

The juncctors in the DSN may be tested by a programmed test. This involves stepping the juncctors one at a time. The order sequence of setting up the test

connections is the same as for a regular "connect" order with the exception of the following:

- (1) The "connect for test" flip-flop is set.
- (2) The 1.5-millisecond busy-test timing is started.
- (3) A test set gate starts the junctor enabler. This permits the junctor to advance one step.
- (4) The test time-out delay is 2 milliseconds instead of 20 milliseconds.

"Release A Side" Order

When a connection in the DSN is to be released from the A side, the central control passes the binary address (of the trunk to be disconnected) to the A trunk selector. This selector translates the binary address into a trunk terminal equipment location on the A side of the DSN on receipt of a signal from the trunk selector control.

A "reset" order is sent along with the "release" order. This order resets the sequence control flip-flops that indicate "operation ended," "operation successful," etc., to the central control.

The central control then sends the "release A side" order to the sequence control. This order sets the RLA (release A side) flip-flop. The sequence control then sends a signal to the A trunk selector control. The trunk selector control signals the trunk selector to place a voltage mark on the trunk terminal to be disconnected. A 2-millisecond timer and a 250-microsecond busy timing interval is started. The junctor release pulser is started. The A and B trunk identifiers are cleared. The tube in the junctor that receives the end terminal mark is fired. This causes the hold current to shift to the release pulser. The change in the hold current causes the junctor match and release detector circuit to send a pulse to the sequence control.

During the first 250-microsecond time-out interval, if the marked terminal is busy, a pulse from the junctor match and release detector circuit sets the sequence control busy flip-flop.

The junctor match and release detector sends a signal to start the "internal clear" sequence of the sequence control. It also causes the "operation successful" flip-flop to be set. The operation of the "internal clear" signal is the same as on a "connect" order, except that a 1.5-millisecond delay is used instead of a 15-microsecond delay. The 1.5-millisecond delay is required to insure deionization

of the junctor release tube. This tube starts to deionize when the release pulser is turned off. On completion of this delay, a positive voltage is sent to the central control indicating "operation ended."

If the trunk network terminal is not busy, the sequence control recognizes this condition, since it will not receive a busy signal during the busy-test timing interval.

The 250-microsecond busy-test timer times out.

The sequence control returns the "operation ended", "not busy", and "operation not successful" signals to the central control.

"Release B Side" Order

The "release B side" sequence is the same as the "release A side" sequence except that the B trunk selector is energized instead of the A side trunk selector.

"Clear" Order

If an order is in progress in the sequence control, and the central control desires to change it (without waiting for completion of the time-out period), a "clear" order can be given to the sequence control. A "clear" order may also be given if the check (CK) output to the central control remains positive (because of some circuit fault) after the operation is ended.

The "clear" order consists of a positive voltage from the central control. It resets the busy-test delay, and starts the "internal clear" sequence. The "clear" order positive voltage is removed by the central control within 200 microseconds.

4 . 4 . 3 Trunk Selector Control, A or B Side, 0 or 1 Marker (Fig. 4-12)

A trunk selector control is connected to the A and B selectors. It is made up of amplifiers, flip-flops, setgates, and release pulsers.

The trunk selector control acts on signal orders received from the sequence control to operate and control the trunk selector. The trunk selector control sets and reads the vertical and horizontal translator cores. It also turns on and off the memory amplifiers in the F and K sections of the trunk selector.

4 . 4 . 4 Trunk Selector, A or B Side, 0 or 1 Marker (Fig. 4-12)

The trunk selectors A or B control the connection of trunks on the A and B sides of the DSN. Both selectors are identical.

The trunk selector receives a nine-bit binary address from the central control corresponding to a particular network trunk terminal in the DSN. It places a voltage mark on that network trunk terminal, and later removes it when ordered by the sequence control.

The selector translates the coded signal (a binary address) into the trunk equipment location in the network. The translation is made through a combination of positive and negative amplifiers, and core matrices. The selector is divided into two parts, F and K, with F and K input leads from the central control and F and K output leads to the DSN. Signals through the F part of the selector determine the network switch location. Signals through the K part of the selector determine the terminal (level) within this network switch.

The selector receives the nine-bit binary address from the central control over F and K leads. The input address is translated into two output signals. The two output signals are then passed to the network as positive and negative outputs, over F and K leads, to make active the network terminals selected. Each network terminal contains a resistor as well as a gas diode which completes the selected path.

4.4.5 *Trunk Identifier, A or B Side, 0 or 1 Marker (Fig. 4-12)*

The primary use of the trunk identifier is to obtain the second trunk terminal address in the DSN and send it to the central control. There are two trunk identifiers in the DM. One serves the A side, the other the B side of the DSN. The trunk identifiers, on obtaining the trunk terminal location in the DSN, process this information in the opposite order to that of the trunk selectors: i.e., the equipment location is translated back into the original order or address. The central control can compare the information received from the in-service marker trunk identifier with that received from the stand-by marker trunk identifier. When the central control recognizes a mismatch, it is recorded on the teletypewriter. Programmed routines are automatically started by the system.

The trunk identifier is made up of two sections, F and K. These consist of a combination of amplifiers, flip-flops, identifiers, and core matrices.

The trunk identifier receives the trunk terminal equipment location in the DSN as a two-part address over the F and K leads. The two-part input address is then translated, in the F and K sections of the trunk identifier, and passed as a nine-bit binary address to the central control. As previously explained, the central control compares this address with that received from the stand-by marker trunk identifier.

4.4.6 Propagator Pulser, A or B Side, 0 or 1 Marker (Fig. 4-12)

The description of the trunk selector covered the selection and marking of network trunk terminals in stage 1 of the A side and stage 6 of the B side of the DSN. The transmission path between these terminals is through switching stages 1, 2, 3, on the A side and 4, 5, 6, on the B side of the DSN. The propagator pulsers are made up of a combination of flip-flops, amplifiers, and release pulsers. The propagator pulsers receive their signal orders from the sequence control circuit. Ten A propagator pulsers furnish the fan-out current for the linkage between stages 1 and 2. Ten B propagator pulsers serve the linkage between stages 5 and 6. All ten A and ten B propagators are pulsed at the same time.

When a mark voltage is applied to the network trunk terminal at either end of the DSN, the voltage drop across the first tube exceeds the breakdown potential so that it fires. Firing the first tube in stage 1 or stage 6 shifts the input voltage to the associated propagator. This voltage shift is applied through a capacitor and superimposed on the anode of the propagator tube, causing it to fire. The propagator pulser then supplies a current into the link clamp. This sets up a fixed marking voltage for the second-stage crosspoint tubes. The voltage applied to the second-stage tubes causes them to fire. The firing of the tubes continues from each side of the DSN until the mark voltages reach the junctor circuits. The gas diodes leading to busy paths are not fired.

A voltage pulse is sent to the trunk release selector. This causes the clearing of the line selector verifier circuit and the trunk level and match detector circuit.

4.4.7 Junctor Enabler, 0 or 1 Marker (Fig. 4-12)

The description of the propagator pulser covered the transmission path from the opposite sides of the DSN through the intermediate stages of the network. The junctor enabler in the DM controls the completion of this path by selecting a junctor in the DSN to connect these two sides of the network.

The juncctors in the DSN function with the following circuits:

- (1) The junctor enabler (in the DM).
- (2) The junctor release pulser (in the DM).
- (3) The junctor match and release detector (in the DSN).

A general description of the junctor enabler operation is given in the following unnumbered paragraphs.

The junctor enabler consists of amplifiers, core matrices, delay circuits, and pulse amplifiers. One junctor enabler circuit is furnished per DM. The junctor enabler acts on orders received from the sequence control.

When the sequence is started by an order from the central control, the propagator pulsers are turned on, and the time-out pulser in the sequence control is set. This pulser measures the interval in which to set up a connection. The busy-check delay circuit in the sequence control is started. If either of the end trunk terminals is busy within the check period, the junctor enabler is not started, and the operation is concluded.

When both end trunk terminals are idle, the junctor enabler is set in operation. The junctor circuit in the DSN recognizes the arrival of marks (voltages) from the two ends of the network. The junctor enabler tests the junctors, in sequence, for the presence of the mark voltages. These two mark voltages in combination with the junctor enabler signal fire the junctor latch tube. This completes the paths from the marked trunk terminals through the six stages of the DSN to the holding potential. A match pulse is generated by the resulting holding current. It indicates the successful completion of the connection.

At the end of the time-out, if neither a successful match nor a busy signal is received, the time-out pulsers report this to the central control. Also, the network controls (selectors, identifiers, propagators, etc.) are cleared.

A clearing signal can be started by:

- (1) The match and release detector (in the DSN).
- (2) The connect or release time-out pulser (in the sequence control).
- (3) The central control.

4.4.8 Junctor Release Pulser, 0 or 1 Marker (Fig. 4-12)

The job of the junctor release pulser is to start the release of the junctor path in the network upon receipt of orders from the sequence control. The orders are carried out in sequence by a combination of flip-flops, amplifiers, and passive delay circuits. The release pulse is applied to all junctors. This fires a release tube in the junctor which received a pulse from the marked trunk terminal. The fired release tube removes the hold current from the latch tube. When the current in the latch tube has decreased below the minimum sustaining current, deionization takes place. Then the release tube in the junctor is deionized by the removal of the common release pulse. This completes the network release.

4.5 METHOD OF OPERATION OF MISCELLANEOUS CIRCUITS

4.5.1 Marker Transfer Circuit—Distribution Marker

The DM transfer circuit consists of a group of wire-spring relays connected in parallel. The operation of the relays is directed by the central control. The leads from the DSN are wired to the fixed contacts. Markers 0 and 1 are wired to the break and the make contacts, respectively. This arrangement permits switching all the network leads at the same time, to either marker 0 or marker 1.

The transfer relays have two windings. If one winding goes open, the second winding can be used. This eliminates the need to replace the relay during a busy period.

A mercury-contact relay under control of the administration center controls the operation of the transfer relays. The mercury-contact relay should be tested or replaced only when distribution marker 0 is in service. This is because the network leads to marker 0 are wired to the break contacts of the wire-spring relays.

4.5.2 Marker Transfer Circuit—Concentration Marker

The operation of the relay transfer circuit for the CM and the SSN network is similar to the operation described for the DM and the DSN.

4.5.3 Power Interrupter Circuit-Interlocks—Distribution Marker

The DM circuit contains twenty-five voltages ranging from +547 volts to -115 volts. To prevent hazardous maintenance conditions in the *stand-by marker*, all high voltages are automatically removed when either the front sliding door or one of the rear gates is opened. Green guard lamps in the front and rear of the cabinet light to indicate when the hazardous voltages have been removed. At this time, package changing and other maintenance work may proceed.

The voltages are *not* removed from the *in-service* marker when a sliding door or rear gate is opened. This is indicated by the absence of a lighted green guard lamp. Marker operation is not interrupted. An "open door" signal is recorded on the teletypewriter, in addition to visible and audible alarms at the administration center.

The power interrupter relay circuitry is arranged to remove and connect the voltages in a definite order. Removing the voltages in a definite order

prevents false operation of the gas tube amplifiers in the trunk selector. Re-connecting the voltages in a definite order insures that the flip-flops are put in their idle state; in addition, this prevents false circuit operations.

The +1.5 and -4.5 volts used for transistor biasing are *not* removed by the interlock circuit. This is done to prevent excessive current through the transistors when other voltages are removed or connected.

4.5.4 Power Interrupter Circuit-Interlocks—Concentration Marker

The power interrupter circuit (interlocks) for the CM is similar to that used in the DM.

4.5.5 Trouble Detectors 0 or 1, Concentration Marker (Fig. 4-13)

Trouble-detecting circuits are provided with the following CM circuits:

- (1) Line selector.
- (2) Trunk enabler.
- (3) Trunk release selector.

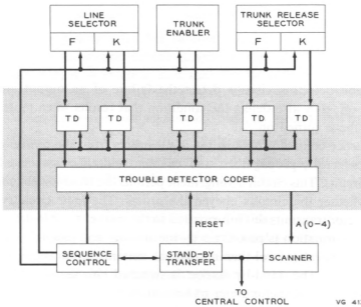

FIG. 4-13. Concentration marker, block diagram of trouble detector.

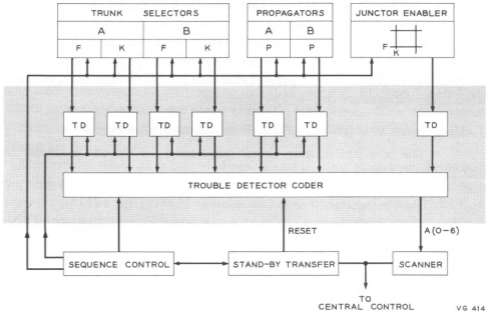

FIG. 4-14. *Distribution marker, block diagram of trouble detector.*

The trouble-detecting circuits detect the failure of an output amplifier to turn on or off; they also detect the condition that results when more than one amplifier tube is turned on.

The sequence control programs the input orders from the central control to the trunk selectors, propagators, and enabler, and their associated trouble-detecting circuits. This circuit arrangement permits the trouble-detecting circuits to check whether the circuits obeyed the orders. The *logic* circuitry within a trouble detector transmits this information to the marker trouble-detector coder. The coded information is picked up by the scanner and relayed to the central control. The central control then notifies the administration center to type out a trouble report. The stand-by marker is switched into service. A reset signal restores the trouble-detector coder to normal. A test program is automatically started to locate the trouble.

4.5.6 Trouble Detectors 0 or 1, Distribution Marker (Fig. 4-14)

Trouble-detecting circuits are provided with the following DM circuits:

- (1) Trunk selectors A and B.
- (2) Propagator pulsers A and B.
- (3) Junctor enabler.

The DM trouble-detecting circuits operate in the same way as those described for the CM in subsection 4.5.5 above.

4.6 MAINTENANCE

To avoid interruption of service, or contact with hazardous voltages in the markers, it is recommended that the following rules be observed before opening a marker cabinet:

- (1) Check the status of the marker lamps at the administration center.

<i>Marker Lamp</i>	<i>Marker Status</i>
White (lighted)	Active (in service)
Red (lighted)	Trouble (or made busy)
None Lighted	Stand-by (matching)

- (2) Upon opening a marker cabinet door, check that the *green guard lamp* in the marker cabinet is lighted. The lighted lamp indicates that the marker is inactive, and that the hazardous voltages have been removed. Maintenance work can now be started.
- (3) When the marker cabinet door is closed, the green guard lamp goes out.
- (4) Depending upon the nature of the maintenance work to be done, routine tests should be started at the administration center before placing the marker in the stand-by condition.

Terminal Strips and Wiring

The terminal strips (at the front of the cabinets) are mounted in a vertical column adjacent to the marker transfer relays (see Fig. 4-6). These terminal strips are associated with the adjacent apparatus.

All input, output, and voltage leads of a unit are terminated on unit terminal strips. One terminal strip on all units is used for the needed voltages and

grounds. A group of punchings on the terminal strip is assigned to each voltage and ground. This assignment is the same for all units. In the roof of the cabinet are mounted the terminal strips used for all input and output leads that interconnect to other frames. Terminal strips are also used for the output leads to the marker transfer. Terminal strips associated with the power interrupter circuit relays (door interlock) are mounted at each end of the power relay mounting plates located in the front lower section of the marker cabinet.

Chapter 5

The Scanner

A telephone switching system must know at all times what the state of each line is. It is the job of the scanner to detect this state. The scanner enables the central control to examine all lines and trunks that terminate in the central office. It tells the central control when the line is "off-hook" and when it is "on-hook." Besides lines and trunks, other points in the system have connections to the scanner. These are used for the system's self-checking program.

There are no "brains" built into the scanner. It works entirely under the command of the central control. And, since its output consists only of "yes" or "no" answers, these must be interpreted by the central control.

The scanning function requires no moving parts. Except for its transfer features, the scanner is completely electronic.

5.1 EQUIPMENT ARRANGEMENTS

The scanner consists of two cabinets designated SC-0 and SC-1*; see Figs. 5-1 and 5-2. These designations are marked near the bottom of the cabinets. Each cabinet contains equipment mounted in two bays. One bay is fixed; the other is movable to provide access to the inside of the scanner. The movable bay is designated 0 and the fixed bay is designated 1. These designations are marked on the lower part of the frame and cabinet. The equipment consists of apparatus assembled on mounting plates. Plate locations are designated by numbers marked on the left edge of the bay frame (00 through 31 on Bay 0, and 00 through 32 on Bay 1). We refer to plates by the use of three-digit numbers, in which the first digit indicates the bay, and the second and third digits identify the plate. Thus 023 indicates plate 23 in Bay 0; 127 indicates plate 27 in Bay 1; etc.

The scanner equipment layout is shown in Fig. 5-3. The rear equipment (Bay 1) is identical in both cabinets, so only one view is shown. Functional designations are marked on the right side of the bay frame opposite the equipment. Table 5-1 relates these equipment designations to the circuit designations.

*Since preparing the illustrations and text for Chapter 5, the designations for the cabinets have been changed to S-0 and S-1.

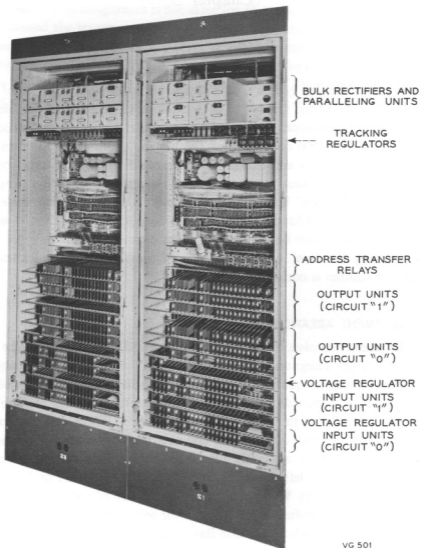

FIG. 5-1. Scanner, front view.

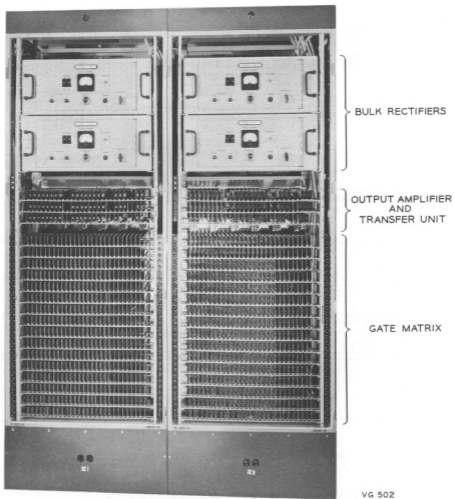

FIG. 5-2. Scanner, rear view.

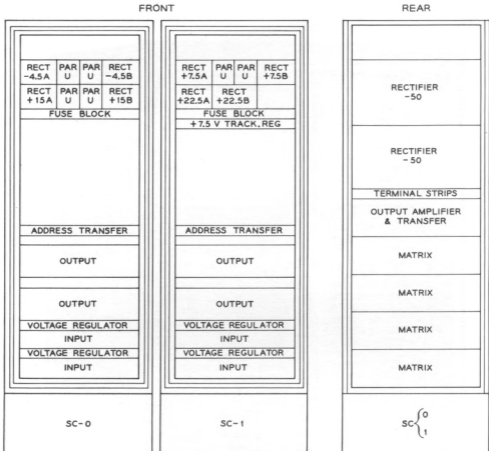

FIG. 5-3. Scanner equipment.

VG 503

5.2 METHOD OF OPERATION

The scanner examines the state of all lines, trunks, and test points on a one-at-a-time basis. Each line, trunk, or test point appears in the scanner as one or two inputs to a transmission gate. These gates are usually referred to as "scan points." They are biased in a forward direction by an "on-hook" condition of the line. They are biased in the reverse direction by an "off-hook" condition of the line. The scanner is directed by the central control, which says in effect, "Look at such-and-such a scan point and let me know whether its line is in the

TABLE 5-1. EQUIPMENT DESIGNATIONS

Functional Designations	Circuit Designations
A D D T R	Transfer Control Relays Address Transfer Relays
I N	Gate Input Transfer Relays Input Translators Input Selectors Gate Amplifiers Drivers Pulsers Cable Terminator Load-Sharing Resistors
O U T	Lock-Up Amplifiers Reset Amplifiers Emitter-Follower Amplifiers Output Translators Output Selectors Detectors
M A T R I X	Gate Matrices (partial)
O P A T R	Part of Gate Matrices Output Amplifiers Gate Output Transfer Relays

on-hook or the off-hook state." The scanner examines the scan point as directed and reports back to the central control a simple answer, "on-hook" or "off-hook."

Scanning—Fig. 5-4

This one-at-a-time sampling operation is carried on in two distinct types of scan. One, called "supervisory scan," samples each scan point every 100 milliseconds. This is often enough to supervise those lines in which there are no

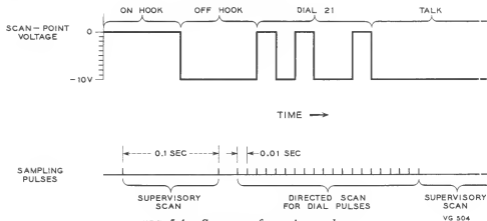

FIG. 5-4. Sequence of scanning modes.

rapid changes in state. The other scan, called "directed scan," is for lines having rapid changes in state (dial pulsing). During this directed scan, the central control directs the scanner to each dialing line every 10 milliseconds. It must sample these lines ten times as often as during the supervisory scan, to be sure that no changes in state representing dial pulses escape detection. With dialing at the rate of 20 pulses per second, each dial pulse is about 50 milliseconds in duration. You can easily see that a dial pulse could occur *between* scans at the supervisory rate of one scan every 100 milliseconds.

The scanning cycle, which repeats every 100 milliseconds, is made up of ten 10-millisecond periods (see Fig. 5-5). In each period, the central control directs the scanning of all lines that are being dialed, and 1/10th of all the scan points in the system. The balance of the 10-millisecond period is taken up with other functions of the central control external to the scanner.

We have said that the central control directs the scanner to look at these scan points and report their state. How is this sampling accomplished? Essentially, there are two things to be done: (1), a point must be selected; and (2), its state must be detected. To do this, the central control sets up a route through the point to be observed. It then sends out an interrogation pulse, called the enable scanner pulse (ENS). This pulse follows the route laid out in the scanner. If the line is on-hook, the pulse passes through the scan point and this will be indicated to the central control. If the line is off-hook, the pulse is blocked; this too is indicated to the central control.

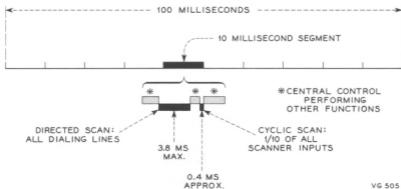

FIG. 5-5. Scanning cycle.

The arrangement of the scan points is in the form of a grid or "matrix" (see Fig. 5-6). Each scan point is connected between intersecting leads of the matrix. There are 32 horizontal and 32 vertical elements in this matrix. These would form 1024 points of intersection, or scan points, if completely equipped. But the Morris equipment provides for only 904 scan points.

There are *two* such matrices in this scanner, together with their associated input and output circuits. They have common input connections to the central control, so they are always working in parallel. But they put out separate answers, and the central control has the "sense" to pick the proper one. To simplify the explanation of scanner operation, let us consider the working of only *one* matrix. The other works in exactly the same way.

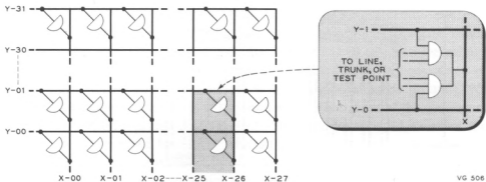

FIG. 5-6. Matrix of transmission gates.

Matrix—Fig. 5-6

The matrix is the heart of the scanner. We have said that it consists of 32 vertical and 32 horizontal buses, with a transmission gate across each of the working points of intersection. Each gate connects to a line, a trunk, or a test point. The idle or busy condition of each of these parts of the system results in a particular set of voltages at the input of its associated transmission gate in the matrix. These sets of voltages bias the gates either in a forward direction (idle) or in a reverse direction (busy). Forward biasing allows pulses to pass through the gate. Reverse biasing blocks the pulses. This passing or blocking of the pulse indicates to the central control the state of the line being scanned.

Now, how do we determine which one of the scan points will be interrogated at any given instant? In Fig. 5-6, notice that each transmission gate combines a particular horizontal bus with a particular vertical bus. So, when we interrogate a horizontal bus together with a vertical bus, the gate, or scan point,

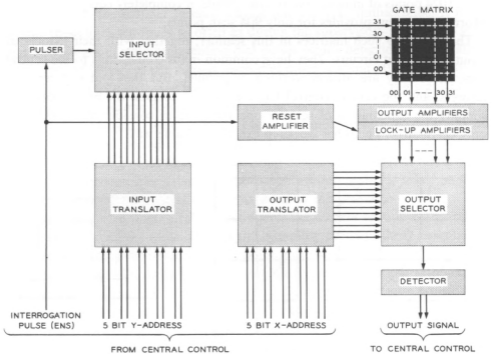

FIG. 5-7. Scanner block diagram.

common to these two buses is placed in the active circuit. The part of the scanner that steers the pulse to a particular horizontal bus is called the input selector (see Fig. 5-7). The parts that set up the return path from the vertical bus are the output selector and the detector.

Scan Point Selection—Fig. 5-7

The scan points are selected for interrogation by a coded signal from the central control, called an "address." This address consists of d-c voltages on ten pairs of leads. Each pair has a high-voltage lead (approximately 15 volts) and a low-voltage lead (approximately 1 volt). These voltage pairs are referred to as "bits." The ten bits of the scanner address are divided into two five-bit groups: "X-address" and "Y-address." The Y-address is applied to an input translator. This translator controls the input selector, which sets up a path to a horizontal bus of the matrix. The X-address is applied to an output translator. This output translator controls the output selector, which selects the output of the vertical buses of the matrix. The arrangement of these units is shown in Fig. 5-7. Now, let us see how these units operate to carry out the scanning function.

Input Selector—Fig. 5-8

The input selector sets up a path for the ENS pulse (enable scanner pulse) to a particular horizontal bus in the matrix. It does this according to the pattern of voltages received from the input translator. The input selector consists of a two-stage transistor "tree" arranged as shown in Fig. 5-8. The first stage consists of a group of eight transistors. It accepts pulses from the pulser. (The pulser restores the shape and amplitude of the pulses sent by the central control.) This stage performs a 1-out-of-8 selection. Each transistor acts as a gate, which is open when its base is at ground potential, and closed when a positive voltage is applied to the base. The input translator provides eight voltages, seven of which are high (+10v) and one of which is low (approximately ground). We apply these voltages to the bases of the transistors. Thus seven of the transistors are always cut off and one is conducting. Since the pulse is fed to all of the transistors at once, we have now selected one out of eight paths—the one through the conducting transistor.

The second stage of the transistor tree operates in a similar manner. It has a group of four transistors for each of the eight transistors in the first stage. The

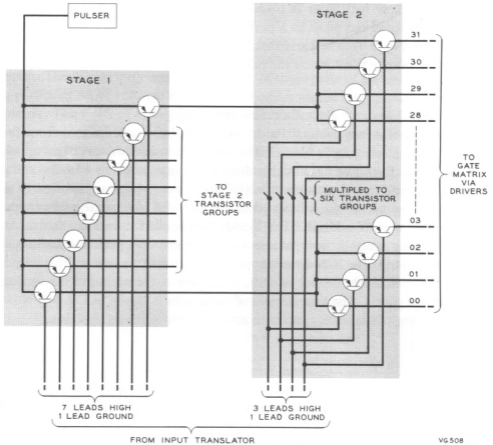
FIG. 5-8. *Input selector.*

pulse from the first stage is fed to the paralleled inputs of one of these groups. The base of each transistor is biased by another section of the input translator. This provides four voltages, three high and one low. As before, we find that there is one conducting path, while the rest are cut off. So we have selected one path out of four, each of which represented a selection of one path out of eight. Now we have made the required 1-out-of-32 selection.

Input Translator—Fig. 5-9

The input translator converts the coded signals of the Y-address into the proper voltage combinations to control the transistors of the input selector.

The input translator is essentially a type of matrix. It contains semi-conductor diodes, which connect horizontal and vertical buses of this matrix in a particular pattern. These diodes permit voltages appearing on the horizontal buses to be transmitted to certain vertical buses.

The input translator operates in two sections: One controls stage 1 of the input selector, and the other controls stage 2. The bits of the Y-address are shown applied to the horizontal buses of the matrix. As we have said before, each bit always has one lead at high voltage and one lead at low voltage. Three bits of the Y-address are applied to the first-stage section. The arrangement of diodes is such that one or more high-voltage address leads is coupled through to each of seven vertical buses. Therefore, these seven verticals are at a high potential. The remaining first-stage vertical is connected *only* to horizontal buses having a low potential, so its potential is low. The second-stage section

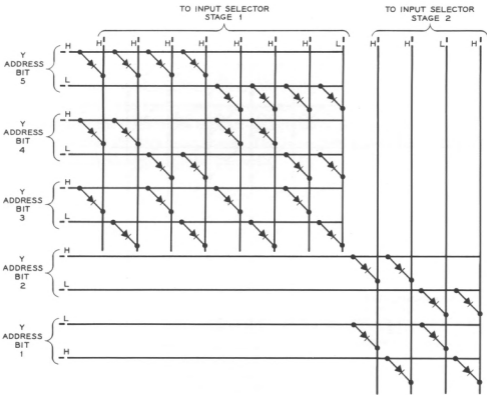

FIG. 5-9. Input translator.

works in the same way. Here we apply the two remaining bits of the Y-address to the horizontals and get out one low and three high voltages from the verticals.

Changes in the Y-address take the form of reversals of potential between leads of one or more address bits. These may occur in any random fashion, but in no case can both leads of a pair be at the same potential at the same time. The effect of these address changes, when applied to the input translator, is to change the location of the low output in one or both sections of the unit. You can see how this happens by observing (in Fig. 5-9), that, for any possible arrangement of address bits, one—and only one—output vertical in each section is connected *only* to low horizontals. All the rest are connected to at least one high horizontal. But *which one* of the verticals will get the low potentials? This is determined by the way in which the address bits are arranged at the time.

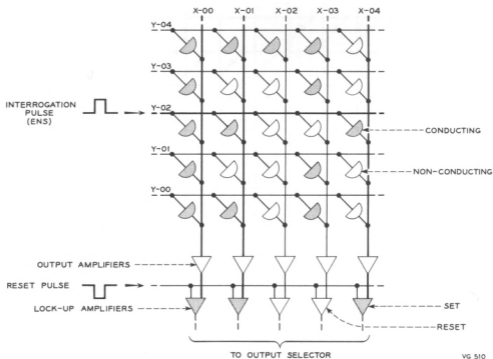

FIG. 5-10. Operation of gate matrix.

Operation of Gate Matrix—Fig. 5-10

The ENS pulse, when fed to a Y-bus of the gate matrix, passes through all of the active transmission gates connected to that bus. If all gates are active, the pulse current is divided among the 32 X-buses. This could cause the current on any one X-bus to be as small as 1 milliamperere. Such small currents must be amplified for effective use. We therefore provide a two-stage transistor amplifier at the output of each vertical, or X, bus of the matrix. This amplifier also discriminates against noise.

The amplified pulse is fed to one or more of the 32 lock-up amplifiers. This is a standard gate amplifier, with external feedback added to provide bistable* operation. It acts as a temporary memory by assuming a "set" state (+16v output) when triggered by a *positive* pulse, and a "reset" state (+1v output) when a *negative* pulse is applied to the input.

A pulse appearing on a Y-bus passes through the active transmission gates to their associated X-buses. The pulses are then amplified and used to set their respective lock-up amplifiers. A set amplifier, then, indicates an active scan point between its X-bus and the Y-bus which was addressed with the interrogation pulse. The lock-up amplifiers remain set until they receive a reset pulse. In this way, they "remember" the condition of the addressed scan points until told to "forget." The reset pulse is an inverted sample of the next ENS pulse. It occurs after the scanning of the lock-up amplifiers, and is timed to reset the amplifiers before the ENS pulse arrives. This is possible because the ENS pulse is delayed in passing through the scanner.

Output Selector—Fig. 5-11

The output selector examines the state of the lock-up amplifiers one at a time after each ENS pulse has been sent. On supervisory scan, it examines all lock-up amplifiers between pulses. On directed scan, it examines only the amplifier called for. It is controlled in this process by an output translator, which converts the X-address into two groups of voltage levels.

The output selector is a two-stage device. The first stage provides an 8-to-1 reduction in the number of possible paths, and the second stage gives a 4-to-1 reduction. The output of each of the 32 lock-up amplifiers is fed to one of the inputs to AND gates in the first stage of the output selector. (An AND gate transmits signals only when *all* of its inputs are activated.) The other input of

*Having two distinct states of stability.

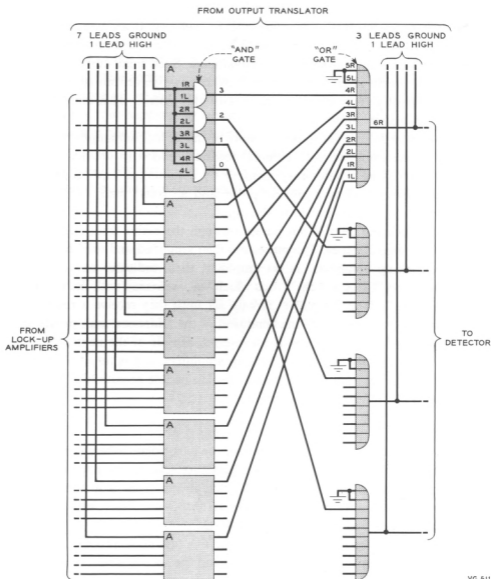

these AND gates receives a group of eight signals from one section of the output translator. These signals consist of eight voltages, one high and seven low. Each of the eight signals is connected to a group of four AND gates. Only the group receiving the high signal will pass information.

The output of these AND gates is connected to the second stage consisting of four OR gates. (An OR gate transmits any signal that appears at its input.) Since only *one* group of four AND gates is active at any given instant, only one signal can appear at each OR gate. The 1-out-of-4 selection of OR gates is done by the signals from the second stage of the output translator. These consist of a group of one high-level and three low-level signals. They are applied to the output of the OR gates, the three low signals effectively grounding out the signals at their gates. We now have only one signal left to give to the detector.

Detector

The detector and its associated amplifier have a simple function. This is to convert the single-rail* output of the selector to an amplified twin-rail† scanner output. This is the required scanner output for use by the central control.

Output Translator—Fig. 5-12

The job of the output translator is a lot like that of the input translator. It must take a five-bit twin-rail address and convert it to an eight-bit and a four-bit single-rail address. However, its output potentials are inverted. To operate the output selector we need a “one-high-and-seven-low” address for stage 1, and a “one-high-and-three-low” address for stage 2.

To obtain this output, three bits of the X-address are connected to AND gates. Note that each AND gate is connected to a different combination of address input leads. This means that, for any combination of address potentials, one and only one AND gate receives all three high voltages of the input address. This gate puts out the high signal. The other seven gates will remain blocked, their outputs being at about ground potential.

The other two X-address bits are connected to a group of four OR gates. To understand this operation, remember that its purpose is to ground out three of the four signals at the output of the selector. The way in which these gates

*A signal represented by the “voltage” or “no-voltage” state of a wire.

†A signal represented by a voltage appearance on one or the other of a pair of wires, the opposite member of the pair being always in the “no-voltage” state.

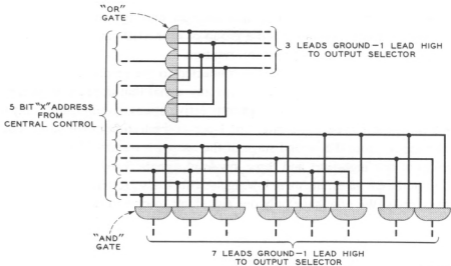

FIG. 5-12. Output translator.

VG 512

are connected causes the flow of information to be opposite in direction to the flow of current. The four signals from the output selector appear on the translator output leads. Two bits of the X-address appear at the output of the OR gates. The low, or ground, part of each bit grounds out all signals passing through the gate. Notice how these gates are connected to the output leads. You will see that for any possible combination of address inputs, three of the four output leads will be connected to gates having grounded outputs. Thus, we achieve the desired address to be applied to the output selector: seven leads ground and one high, and three leads ground and one high.

5.3 DUPLICATION AND TRANSFER

To insure the continuous operation of the system, certain equipment and apparatus are furnished in duplicate. Some power supplies are on a shared load basis. Other duplicated units make up a stand-by circuit. When trouble occurs in a duplicated unit in active service, the stand-by circuit is automatically switched into the system. The circuit containing the faulty unit is switched to stand-by. The fault can then be located and repaired without affecting service.

The duplicated facilities are designated as "0" and "1". These are identified by color coding. Zero circuits are identified by *blue* marking, and "1" circuits are identified by *yellow* marking. The input, voltage regulator, and output units have their functional designation markings color-coded. All other equipment designations are marked in black. Some items of equipment contain duplicated circuits. These are identified by blue or yellow dots, as shown in Figs. 5-13, 5-14, and 5-15.

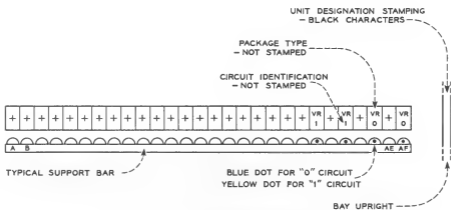

FIG. 5-13. Circuit identification marking (tracking voltage regulators).

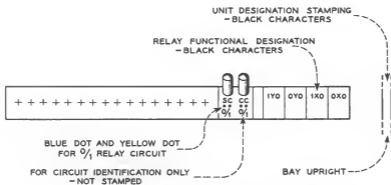

FIG. 5-14. Circuit identification marking (transfer units).

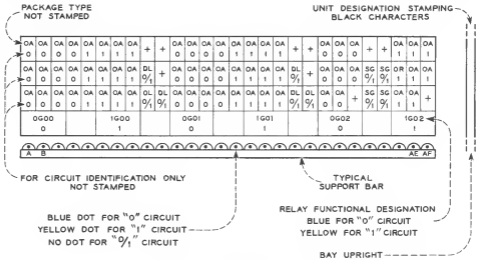

FIG. 5-15. Circuit identification marking (output amplifiers and transfer).

Duplication

All of the scanner circuits are duplicated except the gate matrix, the driver dummy load, and the transfer relays. Since a fault in the gate matrix is not likely to affect more than one line, this large portion of the scanner is not duplicated. The driver dummy load is nothing more than a group of resistors which replace the matrix in the stand-by circuit. Each resistor bridges a horizontal access lead to its corresponding vertical access lead. They match the impedance of the drivers and allow pulses to be passed through the stand-by circuit during routine tests. While the transfer relays, as such, are not duplicated, they have dual-wound coils and twin contacts. This increases reliability.

Transfer—Fig. 5-16

The scanner stand-by circuit is normally switched into active service automatically when the central control detects trouble in the active circuit. This transfer may also be made by typing the proper order on the teletypewriter in the administration center. In emergencies, the transfer can be made by operating keys at the administration center. In any case, the administration center starts the transfer by operating the transfer control relays in the scanner. These relays operate two other sets of relays, called "address transfer relays" and "gate input and output transfer relays."

Figure 5-16 shows the arrangement of transfers. The address transfer relays and the gate input and output transfer relays have only "make" contacts. Half of the contacts on the transfer control relays are normally closed. These put the 0 circuit of the scanner in active service when the transfer control relays are in the released state. The other half of the contacts are normally open. When the relays are operated we break the 0 circuit contacts and close the 1 circuit contacts. This makes the transfer through the various transfer relays.

Note that no switching of the scanner return leads to the central control is shown. This transfer function is taken care of in the central control by a transfer-sensing signal obtained from the gate output transfer.

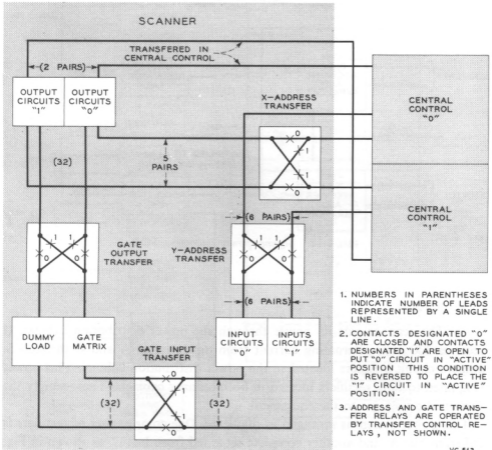

FIG. 5-16. Scanner transfer.

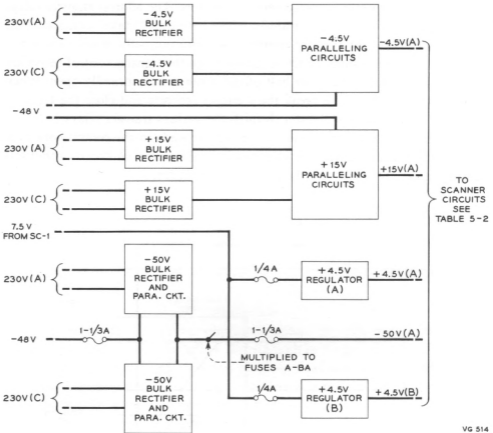

FIG. 5-17. Scanner power equipment, SC-0.

5.4 POWER

The scanner gets its power through the power distribution cabinet. It receives 230 volts alternating current from power buses A and C through 5-ampere circuit breakers located in the power distribution cabinet. This power is applied to bulk rectifiers located in both scanner cabinets. These supply the various d-c voltages to the equipment.

This power system is arranged in duplicate. One complete set of rectifiers is fed from bus A, and another complete set is fed from bus C, as shown in Fig. 1-18. The output from like units in each set is paralleled, either directly or by

connection to parallel loads. This means that failure of the power in either bus, or failure of any rectifier unit, will not put the scanner out of service. In certain cases, however, a circuit transfer may be necessary. The arrangement of power equipment in the cabinets is shown in Figs. 5-1, 5-2, and 5-3.

In addition, -48 volts direct current from the central office battery is supplied through 5-ampere fuses located in the power distribution cabinet. This power is used to operate the transfer relays in the scanner. It comes to the scanner on d-c buses A and C, as shown in Fig. 1-19. The circuit is so arranged that failure of either bus does not disable the scanner. Only its ability to transfer will be lost.

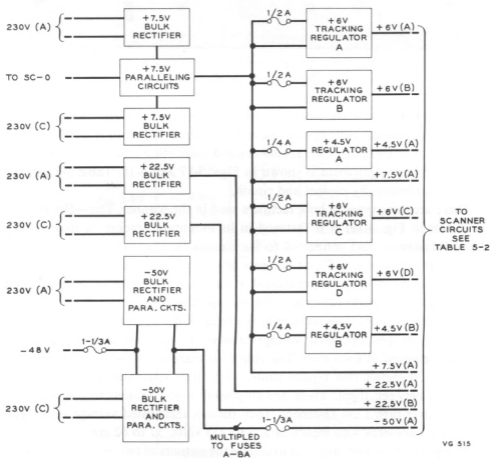

FIG. 5-18. Scanner power equipment, SC-1.

VG 515

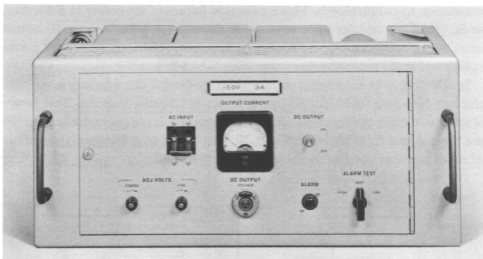

FIG. 5-19. Power supply, -50 volts.

VG 516

Power equipment in the scanner consists primarily of the bulk rectifiers. They contain solid-state rectifying devices, and regulating and filtering circuits. Other units of power equipment are regulators and paralleling units. The general wiring plan of this equipment is shown in Figs. 5-17 and 5-18. Table 5-2 lists the power distribution by cabinet and circuit.

There are three types of bulk rectifiers used in the scanner. The -50v rectifier is shown in Fig. 5-19. It is fastened in its mounting bracket by quarter-turn "Lion" fasteners, and connected to the circuits by plug-in connectors. It supplies its rated voltage $\pm 2\%$ at currents of up to 3 amperes with inputs of 226 to 233 volts, 57 to 62 cycles per second. It has a self-contained paralleling circuit and alarm unit, which requires -48v for operation.

The other types of bulk rectifier look exactly alike, except for marking. They differ only in their operating voltage ranges. The rectifiers are adjusted to the voltage required in each case. The voltage is marked on the designation strip. Figure 5-20 shows two typical units, with their associated paralleling units mounted between them. These are all plug-in units, secured to the rear plate with quarter-turn Lion fasteners. They furnish their rated voltage at currents of up to 3 amperes with inputs of 226 to 233 volts, 57 to 62 cps.

The paralleling units are used to isolate the outputs of two rectifiers operating from separate a-c buses into a common load. Each paralleling unit consists

primarily of a silicon diode, which prevents trouble in either rectifier from shorting the load bus. A transistor monitors the diode drop and controls a relay and associated lamps, which indicate circuit failures or maladjustments. Each unit is for use at a particular voltage. They are mounted in the same manner as their associated rectifiers.

The four voltage regulators (see Figs. 5-3, 5-17, and 5-18) each consist of two circuit packages, one each of F-52657 and F-52658. They are located on plates 002 and 005 of each cabinet. They provide +4.5 volts $\pm 1\%$ at loads of up to $\frac{1}{4}$ ampere.

The four tracking regulators each consist of an F-52656 package. All are located on plate 024 of cabinet SC-1. They provide an output voltage which

TABLE 5-2. SCANNER POWER DISTRIBUTION

Fig. No.	Power Lead Designation	Connects to	
		The Matrix in Cabinet	Other Circuits
Fig. 5-20	-50 (A)	SC-0	—
	- 4.5(A)	SC-0	SC-0, Circuits 0, 1
		SC-1	SC-1, Circuits 0, 1
	+ 4.5(A)	—	SC-0, Circuit 0
	+ 4.5(B)	—	SC-0, Circuit 1
	+15	SC-0	SC-0, Circuits 0, 1
		SC-1	SC-1, Circuits 0, 1
Fig. 5-21	-50 (A)	SC-1	—
	+ 4.5(A)	—	SC-1, Circuit 0
	+ 4.5(B)	—	SC-1, Circuit 1
	+ 6 (A)	—	SC-0, Circuit 0
	+ 6 (B)	—	SC-1, Circuit 0
	+ 6 (C)	—	SC-0, Circuit 1
	+ 6 (D)	—	SC-1, Circuit 1
	+ 7.5(A)	—	SC-0, Circuits 0, 1
			SC-1, Circuits 0, 1
	+22.5(A)	—	SC-0, Circuit 0
		SC-1, Circuit 0	
+22.5(B)	—	SC-0, Circuit 1	
		SC-1, Circuit 1	



FIG. 5-20. Power supplies and paralleling units.

tracks below the +7.5 volt input by 1.5 ± 0.1 volts. The top rated load is $\frac{1}{4}$ ampere.

There are 28 isolation networks, each consisting of an F-52631 package. They provide filtering of the d-c power to those circuit packages that do not have their own filters. They are located on plates 002, 005, 006, 007, 008, 010, 011, and 012 in both cabinets.

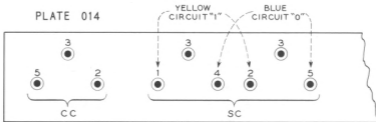

- 1 - JACKS NUMBERED "3" ARE GROUNDED,
- 2 - ALL JACKS NOT OTHERWISE DESIGNATED ARE BLACK.
- 3 - TO REMOVE "CC" RELAY: WHEN CIRCUIT "0" IS ACTIVE, PATCH JACK 3 TO JACK 5. WHEN CIRCUIT "1" IS ACTIVE, PATCH JACK 3 TO JACK 2.
- 4 - TO REMOVE "SC" RELAY: WHEN CIRCUIT "0" IS ACTIVE, PATCH JACKS 3 TO JACK 4 AND JACK 5. WHEN CIRCUIT "1" IS ACTIVE, PATCH JACKS 3 TO JACK 1 AND JACK 2.

FIG. 5-21. Relay contact patching.

5.5 MISCELLANEOUS

Cabinet SC-1 contains a relay designated RFA. This relay starts the alarm circuits in the administration center whenever a fuse blows in the 7.5-volt circuit feeding the regulators. It also causes the administration center to start action to transfer the scanner to its stand-by circuit.

Each scanner cabinet contains three test blocks. All three blocks have a $-48v$ test terminal, a ground terminal, and a high-resistance (12,000 ohms) ground terminal. Two blocks have trouble indicator lamps and a $-48v$ test jack. The trouble lamps show which of the scanner circuits is in trouble. The third block has a $+22.5v$ test terminal.

Each cabinet has four feed-through terminal strips, designated A, B, C, and D. Power leads are connected to strip A; address leads to strip B; ENS, transfer control, and administration center leads to strip C; and matrix diagonal test point leads connect to strip D.

The scanner cabinets contain the alarm relays, alarm indicator lights, and power receptacles common to all ESS cabinets. Also, one cabinet has a set of jacks mounted near the alarm lamp. These are connected to similar jacks throughout the system for intercommunication.

5.6 MAINTENANCE

Maintenance on equipment while in service is seldom needed because of the extensive duplication of scanner circuits. The routine test program of the system detects circuit failures and automatically switches the scanner stand-by circuit into service. Indicator lamps, mounted on the test blocks at the front and rear of each cabinet, show which of the duplicated circuits is in trouble. At the same time, the teletypewriter in the administration center prints out a coded message indicating the source of the trouble. This trouble report usually points out the location of the fault within two or three units. Replacing these units should correct the trouble.

The modular design used in the ESS permits us to perform primary maintenance by replacing plug-in units. These may consist of circuit packages, fuses, certain relays, or power supply units.

Circuit packages are described in Chapter 1 and shown in Fig. 1-9. Those used in the scanner are all of the narrow, or "a," type. Table 5-3 lists these packages.

TABLE 5-3. PACKAGES USED IN THE SCANNER

F.Spec. Number	CPS* No.	Quantity	Name
F-52603	48	168	Gate Amplifier
F-52605	50	20	Emitter-Follower Amplifier
F-52615	1	32	AND Gate 2-2-2-2 Input
F-52617	3	12	AND Gate 3-3-3 Input
F-52621	17	8	OR Gate (No Resistor) 2-2-2-2 Input
F-52622	18	16	OR Gate (No Resistor) 10 Input
F-52625	21	16	OR Gate (2610 Ohm Resistor) 10 Input
F-52631	155	28	Isolation Network
F-52635	56	64	Driver Amplifier
F-52637	83	40	Input Selector Transistors
F-52638	55	4	Pulser Amplifier
F-52639	57	4	Reset Amplifier
F-52640	58	128	Output Amplifier
F-52641	31	680	Line Gate
F-52642	84	8	Input Translator, Stage 1
F-52643	85	4	Input Translator, Stage 2
F-52646	145	4	Input Selector Resistors
F-52648	32	224	Special Gate
F-52649	183	4	Cable Terminator
F-52651	184	4	Detector
F-52652	68	4	Detector Amplifier
F-52653	149	12	Driver Dummy Load, Resistors
F-52655	186	8	Load-Sharing Resistors
F-52656	195	4	Tracking Voltage Regulator, +6.5v
F-52657	190	4	Voltage Regulator, +5 to +8 volts, Board A
F-52658	190	4	Voltage Regulator, +5 to +8 volts, Board B

*CPS means Circuit Package Schematic.

The thirty-two F-52725 wire-spring relays are not easily replaced. But they have dual-wound coils, one winding being a spare. If a winding fails, we can restore the relay to service by moving the connecting wires from terminal 1U to terminal 2U. This places the spare winding in the active circuit.

The 276F and the four 275A mercury contact relays are of the plug-in type. In replacing the 275A relays you must take special care. You may disable the system by pulling out a relay, unless you first patch across the proper relay contacts to maintain control of the circuit. Special pin jacks and patch cords have been provided for this purpose. Jacks are mounted on the same plate as

their associated relays. Note which of the scanner circuits is active and make the proper connections, as per Fig. 5-21, to keep the circuit active. Then remove the relay. Be sure to remove all jumpers after replacing the relay.

Failure of any power supplies or fuses is indicated by an alarm at the administration center. Alarm lamps are also provided on the —50v bulk rectifiers and the paralleling units. Replacement of this plug-in equipment is not difficult. This is covered in the circuit descriptions of the various equipment items.

CAUTION The —50v bulk rectifiers weigh 74 pounds each. When you remove any of them, be sure to have enough help to prevent dropping the unit on the unprotected equipment below.

Chapter 6

The Stand-By Transfer

6.1 GENERAL

To assure reliable service, some units in the ESS are duplicated completely; others are partially duplicated. This allows the system to compare outputs from duplicated units. Matching circuits and trouble-detecting programs tell the system which unit is faulty. If the faulty unit is the active* unit, it is switched out of service and its duplicate is put into service.

A Stand-by Transfer (ST) is used in the ESS to set up transfer paths between the Central Control (CC) and other system units directed by CC. These paths are shown in Fig. 6-1. The stand-by transfer uses relays and semi-conductor devices to set up the transfer paths as required.

Besides the transfer function, ST carries out other functions that are really part of central control operations. The circuits that perform these other functions are:

- (a) the central control matching circuit;
- (b) the marginal voltage test circuit;
- (c) the flying spot store (FSS) control circuit; and
- (d) the master clock pulse generator circuit.

These circuits are located in ST because of electrical and equipment design requirements.

Central Control Matching Circuits

In the Morris ESS, the central control is duplicated. At any given time, one CC is active and the other is in stand-by condition. The central control matching circuits match the following outputs from both central controls:

*"Active" means providing customer service.

- (a) bus;
- (b) parity check* and error correction;
- (c) barrier grid store (BGS) orders; and
- (d) flying spot store (FSS) orders.

If a mismatch is detected, the system quickly determines which CC is at fault. If it is the active CC, it is switched out of service and the stand-by† CC is made active. The system then continues with its business, and the CC taken out of service can be worked on.

Marginal Voltage Test Circuits

The Morris ESS uses marginal voltage test circuits to test flip-flops and gate amplifiers in CC and ST circuits. These marginal voltage tests are made to detect possible sources of trouble. The tests are applied automatically once a day, or at any time on the request of the maintenance craftsman.

Flip-flops are tested in groups of one to twenty-six. The +22v is lowered in four steps to +17v. The flip-flops are checked at each step; the time allowed for each step is 1.5 seconds.

The gate amplifiers are checked in groups of one to ten. The -4.5v is lowered in four steps to -2.5v, and increased in four steps from -4.5v to -6.5v. Each step in this test takes 1.5 seconds.

Flying Spot Store Control Circuits

On the basis of information supplied by the two central controls, the FSS control circuits determine which order lead is made active to the FSS's. There are six order lead outputs from these circuits. The lead selected gives the next order to the FSS's. The leads and orders are designated advance, transfer, rest, scan, operate, and expose. The orders for the FSS's are explained in Chapter 9.

Master Clock Pulse Generators

The master clock pulse generators supply a 0.3-microsecond pulse at a rate of 400 kilocycles per second. This pulse is fed to gating circuits, and amplified for use in the central controls and stand-by transfer. There are two of these pulse generators, one for each CC. The active CC determines which pulse generator supplies the controlling clock pulse. The pulse generators are connected so that the one used with the active CC synchronizes the other.

*A check to determine whether the number of 1's is odd or even.

†Not providing customer services, but ready to do so.

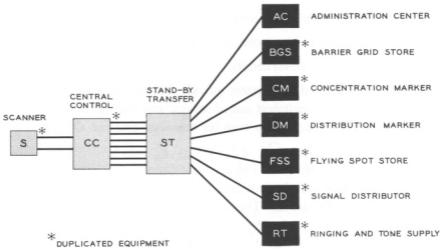

FIG. 6-1. ESS transfer paths.

VG 601

6.2 EQUIPMENT ARRANGEMENTS

Two cabinets contain all the equipment needed for the stand-by transfer. Each cabinet is divided into two bays, front (gate) and rear (fixed). The front bay of each cabinet can be swung open to provide access to the wiring on the front and rear bays. Both cabinets are stamped ST-0. The bays are stamped 0, 1, 2, and 3, near the base of each cabinet. The unit abbreviations are stenciled on the right side of the bay frame.

Front Equipment—Bay 0, Fig. 6-2, Fig. 6-3

Twelve rectifiers and two paralleling units occupy the top third of bay 0. This power equipment is arranged for plug-in unit replacement. To replace any of the fourteen units, you simply loosen the fasteners on the wiring side of the unit, disconnect the a-c cord, and unplug the unit from the front. Guide pins aid you in replacing a power unit.

About one-half of the front bay is unequipped; other units may be added later.

Rear Equipment—Bay 1, Fig. 6-4, Fig. 6-5

At the top of the rear bay are four coaxial cable connectors. Coaxial cable is used to send the high-speed clock pulse throughout the system. Below the

connectors are two rows of terminal strips. The upper row is used to connect this ST cabinet to both central controls. The lower row of terminal strips is marked MISC. These terminals are used to make connections with various other system units.

On the left side of the rear bay are mounted two fuse blocks and one test block.

Front Equipment—Bay 2, Fig. 6-2, Fig. 6-3

At the top of bay 2 are mounted the rest of the rectifiers needed for the ST. These rectifiers are of the same type as in bay 0 (described above), and are replaced in the same way.

Rear Equipment—Bay 3, Fig. 6-4, Fig. 6-5

At the top of this bay are mounted eight coaxial cable connectors. These connectors are used as part of the clock pulse distribution system.

Below the sockets are two rows of terminal strips. Their use is the same as for the two similar rows in bay 1.

In addition, in the rear bay are mounted two fuse blocks and one test block.

Packages and Relays

The ST requires 142 relays for its transfer functions. It has about 879 packages for its electronic circuits. A breakdown of the circuit packages (CPS) and the quantity of each is shown in Table 6-1. The location and designation of packages in the ST are shown on a chart mounted on the door of each cabinet.

Note: Figures 6-2 through 6-5 are shown on pages 178 through 181. Table 6-1 appears on page 182, and the text of Chapter 6 is resumed on page 182.

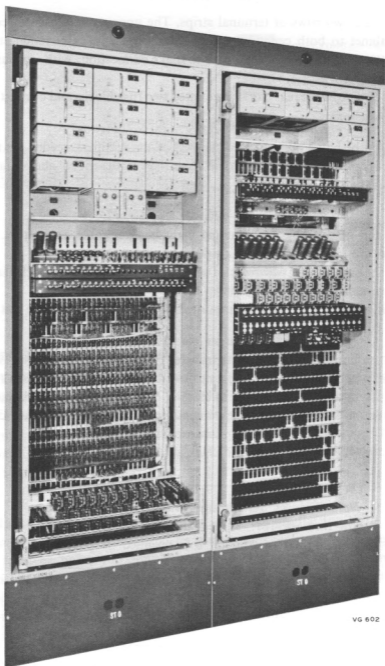

VG 602

FIG. 6-2. Stand-by transfer, front view.

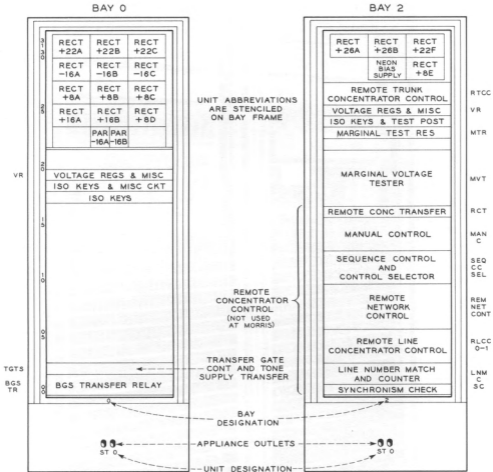

FIG. 6-3. Stand-by transfer, front equipment, Bay 0 and Bay 2.

VG 603

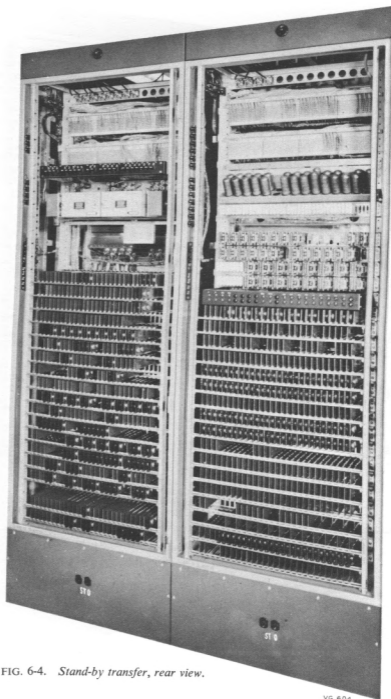

FIG. 6-4. *Stand-by transfer, rear view.*

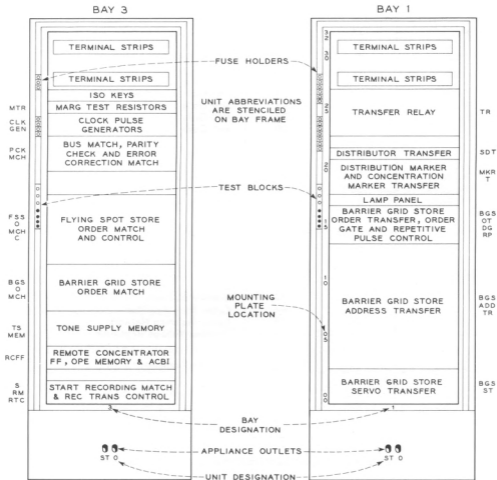

FIG. 6-5. Stand-by transfer, rear equipment, Bay 3 and Bay 1.

VG 605

TABLE 6-1. PACKAGES USED IN THE STAND-BY TRANSFER

F-Spec. Number	CPS* No.	Quantity	Name
F-52600	36	52	Flip-Flop
F-52601	46	39	Flip-Flop to Gate Amplifier
F-52603	48	18	Gate Amplifier
F-52604	49	18	Inverter Amplifier
F-52605	50	5	Emitter Follower
F-52615	1	74	AND Gate
F-52616	2	36	AND Gate
F-52617	3	44	AND Gate
F-52618	4	22	AND Gate
F-52619	5	20	AND Gate
F-52620	16	19	OR Gate
F-52621	17	46	OR Gate
F-52623	19	80	OR Gate with Resistor
F-52624	20	6	OR Gate with Resistor
F-52625	21	2	OR Gate with Resistor
F-52626	22	8	OR Gate with Resistor
F-52627	23	14	OR Gate with Resistor
F-52628	24	13	OR Gate with Resistor
F-52629	25	4	OR Gate with Resistor
F-52630	26	12	OR Gate with Resistor
F-52631	51	44	Isolation Network
F-52633	51	164	Cable Pulse Amplifier
F-52634	156	92	Cable Matching Network
F-52656	195	3	Tracking Voltage Regulator
F-52659	189A	3	Voltage Regulator
F-52660	189B	3	
F-52672	41	10	Clock Coupling Network A
F-52673	42	10	Clock Coupling Network B
F-52674	43	8	Clock Pedestal Network
F-52675	198	10	Voltage Divider

*CPS means Circuit Package Schematic.

6.3 POWER

The stand-by transfer uses two office power supplies, 230 volts of alternating current and -48 volts of direct current. The 230-volt current is fed on three buses, A, B, and C. The -48-volt direct current is fed on two buses, A and B. The office power is connected in ST in such a way that the ST circuits

associated with other units in the system are fed from the same bus that feeds these other units.

The bulk rectifiers used in ST are marked: +22A, +22B, +22C, -16A, -16B, -16C, +8A, +8B, +8C, +8D, +26A, +26B, +16A, and +16B.

Two paralleling units are needed to insure voltage for some important transfer relays. These paralleling units are associated with the -16A and -16B rectifiers. If either the 230v A bus or the 230v B bus fails, the good bus supplies its rectifier; the paralleling units shift the load to that rectifier. This keeps the load supplied at all times.

6.4 MAINTENANCE

The stand-by transfer is not a duplicated unit. When you are maintaining it, you are working in an active system unit.

CAUTION Don't do any maintenance in the stand-by transfer cabinets until you are positive which circuits are active and which are stand-by.

There are two indicating lamps in each cabinet, one *blue* for the "0" functional circuits, and the other *yellow* for the "1" functional circuits. The lighted lamp tells which circuits can be worked on.

When directed to the match circuits in the ST, you may pull packages even in the circuits where the indicating lamp is off. This is feasible, because the system disregards the match circuits at this time. When maintenance is completed, the maintenance craftsman must tell the system, via a teletypewriter message, that the unit is again ready for service.

Several equipment features for locating troubles quickly are included in the ST cabinets. For example, four panels of isolation keys (see Figs. 6-2 and 6-4), are included to isolate bulk rectifier troubles in both cabinets. You are directed to a faulty rectifier by a fuse alarm. This alarm also gives line-up lamp* and cabinet lamp indications. Also, a teletypewriter print-out of a voltage monitor test specifies the location of the rectifier. The isolation key or keys associated with a rectifier have the same designation as the rectifier followed by a 1, 2, or 3 (e.g., +22A1, +22A2). When you see which rectifier circuit breaker is tripped (OFF), turn OFF the isolation key or keys associated with it. This disconnects

*A lamp at the end of an aisle, formerly called an aisle lamp.

the load. Then reset (turn on) the rectifier circuit breaker. If it trips again, the rectifier is faulty.

If the rectifier circuit breaker did not trip with the load removed, make sure that the main breaker in the power distribution cabinet (PD) is reset. If it is reset (ON), turn the first isolation key ON. If this trips the rectifier circuit breaker, the trouble is in the load connected through that key. To determine which mounting plate load causes the overload, turn the isolation keys ON and OFF (one at a time) and remove the isolation networks associated with each key, one at a time.

Another feature for locating trouble quickly is a lamp panel, shown on Fig. 6-4, Bay 1. The lamps on the panel are associated with double-wound mercury relays. There are two lamps for each relay, one for each winding. Each lamp has the same designation as its relay, followed by a 1 or 2. Each lamp is in series with a relay winding and across a current-limiting resistor. Therefore, with the relay operated, both lamps should be ON; with the relay released both lamps should be OFF. One lamp ON and one OFF indicates a trouble, either in a lamp or in a relay winding.

CAUTION This kind of trouble is not detected by the system. Therefore, before you do any maintenance, make busy, via the teletypewriter, the unit associated with the relay.

Now check the lamp. If the lamp is bad, replace it. If the lamp is good, replace the relay.

CAUTION Don't remove any mercury contact relays until the state (operated or released) of the relay has been determined.

When the state of the relay is known, strap the proper contacts to keep them made. Jacks for strapping the relay contacts should be used to keep the contacts closed. Now replace the relay with another relay of the same code, and remove the strap. Tell the system, via a teletypewriter message, that you have finished.

CAUTION Handle mercury contact relays gently to prevent contact bridging.

Double-wound relay troubles are found by looking into the cabinet. They should be cleared during slack periods. When removing mercury contact relays, you may use the 603A tool.

Single-wound relays with open windings or open contacts are detected by the system as open paths between units. You are directed to these troubles by a teletypewriter print-out.

Chapter 7

The Signal Distributor

Not all parts of the ESS work at the same speed. And not all use the same power. For instance, the central control works at microsecond speeds from low milliwatt power signals. Relays in trunk circuits work at millisecond speeds and from higher power levels. To make these different units work together a Signal Distributor (SD) is included in the system. The SD converts and distributes the very fast signals from the central control to other units of the system. It converts high-speed (microsecond) low-power signals received from the central control to low-speed (millisecond), higher-power signals needed to direct certain operations in the system. It distributes these signals to the other units shown in Table 7-1.

The signal distributor consists of a selector and a large group of flip-flops, with their associated amplifiers; see Fig. 7-1, a functional diagram of the signal distributor. The selector translates the input information to a particular output. Each flip-flop acts as a memory element and accepts two high-speed inputs from the selector. These inputs indicate the beginning and end of an output signal. The amplifiers provide the power needed to operate relays.

7.1 EQUIPMENT ARRANGEMENTS

Front and Rear Views—Figs. 7-2 and 7-3

The SD is a self-contained unit. All the electronic circuit packages, power supplies, and relays are mounted in one enclosed cabinet. The cabinet is divided into two bays, a front (gate) bay and a rear (fixed) bay. The front bay can be swung open to provide easy access to the wiring on both the front and rear of the cabinet.

Front Bay—Fig. 7-2

The upper half of the front bay is occupied by power rectifiers and paralleling units. This power equipment is of the plug-in type. Any of the eighteen rectifiers

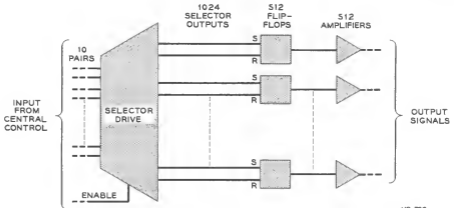

FIG. 7-1. Signal distributor, functional diagram.

TABLE 7-1. OPERATIONS DIRECTED BY
SIGNAL DISTRIBUTOR OUTPUTS

Circuit	Operations
Trunk	Signaling Dial Pulsing Supervising Controlling PBX Functions Controlling Customer Group Services
Administration Center	Switching Major System Components Applying Marginal Voltage Conditions Operating Alarms Aiding Voltage Monitor Circuit Operating Teletypewriter Equipment
Central Control	Resetting Timers
Stand-By Transfer	Controlling the Photographic Store Plate Exposure
Scanner	Comparing Trouble-Checking Circuitry in Scanner and Signal Distributor

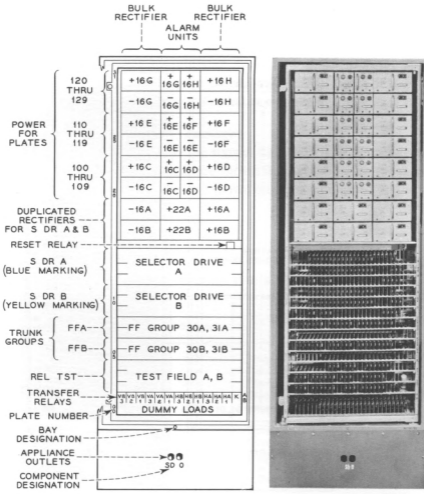

FIG. 7-2. Signal distributor, front view and front equipment.

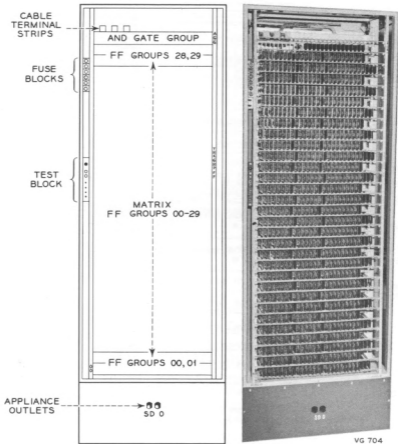

FIG. 7-3. Signal distributor, rear view and rear equipment.

or twelve paralleling units can be replaced by loosening the fasteners on the wiring side of the unit, disconnecting the a-c cord, and unplugging the unit from the front. The lower half of this bay is made up of the various duplicated units in the signal distributor.

Rear Bay—Fig. 7-3

The rear bay consists of the equipment shown in Fig. 7-3. On the upper left side of the cabinet is mounted a fuse block housing six fuses. Directly below the fuses is a test block for testing office battery voltages.

Packages

The electronic circuits of the SD use sixteen different types of packages. The total number and types of packages are shown in Table 7-2. The location and designation of the various packages are shown on a chart mounted on the doors of the cabinet.

TABLE 7-2. PACKAGES USED IN THE SIGNAL DISTRIBUTOR

F.Spec. Number	CPS* No.	Quantity	Name
F-52600	36	546	Transistor Flip-Flop
F-52601	46	4	Flip-Flop to Gate Amplifier
F-52602	47	271	Flip-Flop to Relay Amplifier
F-52606	137	2	Delay Network
F-52607	6	33	Special AND Gate
F-52608	53	22	Translator Driver Amplifier
F-52609	54	64	Driver Amplifier (Signal Distributor)
F-52611	86	32	Translator Diode Matrix
F-52612	152	2	Bias Circuit
F-52613	150	22	H Dummy Load
F-52614	151	6	V Dummy Load
F-52620	16	16	Six-Input OR Gate
F-52622	18	102	Ten-Input OR Gate
F-52631	155	21	Isolation Network
F-52634	156	2	Cable Matching Network
F-52694	129	4	T Dummy Load

*CPS means Circuit Package Schematic.

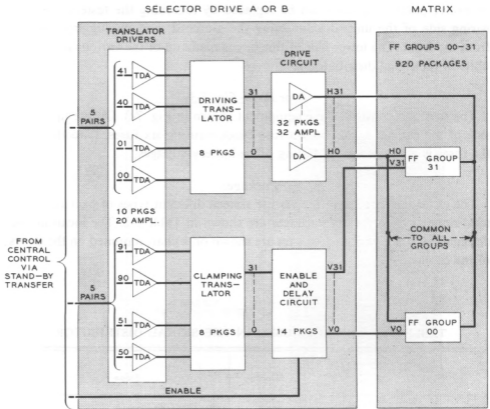

FIG. 7-4. Signal distributor, block diagram.

VG 705

7.2 METHOD OF OPERATION

7.2.1 General Description of Operation

Because the scanner, administration center, central control, stand-by transfer, and trunk circuits need d-c signals to help do their job, they are assigned to specific outputs of the SD; see Table 7-1. Each output is used to direct only its assigned circuit. For example, one output controls the operation and release of the supervisory relay in a particular outgoing trunk circuit. When the central control wants to seize that trunk, it sends a ten-digit binary address to the SD. The SD translates this to a specific location in the output matrix.

The address is received on ten pairs of input leads. Each pair has one lead high (+16v) and one lead low (ground). The lead that is high we'll call +,

and the low lead, $-$. Thus, there are two states for the first pair of leads ($+ -$, $- +$), and every additional pair doubles the number of states. Thus 1 pair = 2 states (2^1), 2 pairs = 4 states (2^2), 3 pairs = 8 states (2^3), and so on to 10 pairs or 1024 (2^{10}) possible states of input leads. Since relays must be operated and released, each output needs two states. Thus from 1024 inputs we get 512 outputs, which can be used to operate or release a relay.

To simplify the understanding of the operation of the SD this description is divided into six functional parts, as indicated on Fig. 7-4. The following paragraphs describe each of these six parts and how they work together to perform the functions of the SD.

7.2.2 Selector Drive A or B

Translator Drivers

Twenty Translator-Driver Amplifiers (TDA) make up this part of the SD. There are two amplifiers on one package, so ten packages are needed. These amplifiers accept the address from the central control, via the stand-by transfer. Each amplifier applies either +16v or ground to the inputs of each translator.

Driving and Clamping Translators

There are two identical diode translators, driving and clamping, in the SD. Each translator has eight 20-diode packages (160 diodes). The eight packages for each translator are connected to form 32 five-input AND gates. The proper arrangement of voltage and ground on the input leads makes one AND gate output lead active. We now have one active output lead from each translator.

Drive Circuit

The drive circuit consists of 32 Driver Amplifiers (DA) one for each driving-translator output lead. The active output lead from the driving-translator turns on one driver amplifier. This amplifier output places 22v on one input lead of one flip-flop in each of the 32 flip-flop groups of the output matrix. Now 32 flip-flops are prepared for a selection. Only one driver amplifier is active at a time, because only one translator (driving) output lead is active at a time.

Enable and Delay Circuit

The enable circuit is a diode package group consisting of 32 diodes. The diodes, one for each clamping translator output lead, clamp all the outputs to

ground. This keeps the translator inactive, while the inputs to the SD are being changed. It prevents the SD from translating these changing inputs into false outputs of its own. To unclamp the enable-circuit diodes, the distributor receives a 0.3-microsecond pulse along with the address. It is called the "enable pulse" because it unclamps the diodes of the enable circuit. The pulse is received by the delay circuit. In the delay circuit this pulse is delayed 5.5 microseconds and then passed as a 2-microsecond pulse. During the delay the translator is inactive. In the 2-microsecond period it is unclamped or active. The sum of these times, 7.5 microseconds, is the maximum speed at which the signal distributor can operate.

7.2.3 Matrix (Flip-Flop Groups 00 through 31)

There are 32 vertical groups of flip-flops in the SD. Each group is composed of fifteen flip-flops, fifteen flip-flop-to-relay amplifiers, one AND gate and three OR gate packages. The matrix shown in Fig. 7-5 is a detailed sketch of the one shown in Fig. 7-4.

The drive circuit prepares the matrix for a selection by applying +22v on one of the 32 horizontal leads. Assume lead H0. You can see from Fig. 7-5 that the H0 horizontal lead is common to 32 flip-flops, one in each of the 32 groups. The clamping translator, which feeds the verticals of the matrix, selects one of its output leads; let's assume V31. This activates one flip-flop group.

The flip-flop controlled output circuit in Fig. 7-5 shows what an actual output looks like. The outputs from two AND gates are connected to a flip-flop. The outputs of the flip-flop are connected to a flip-flop-to-relay amplifier. When the H1 lead has the +22v on it, and the V31 lead is unclamped by the clamping translator, an output from AND gate 1 sets the flip-flop. The flip-flop's set output lead activates the FR amplifier and its output lead goes to ground. This ground is the signal from an output that operates the supervisory relay in a trunk assigned to this output point.

To put this output in its reset state, the central control sends another address. This address selects the H0 lead and V31 lead in the matrix. AND gate 0 transmits an output, and the flip-flop resets. The FR amplifier turns off and removes the ground. The relay in the trunk releases.

Though all outputs are selected in the manner explained above, not all outputs are controlled by flip-flops. AND gate Group 30 is made up of fifteen spe-

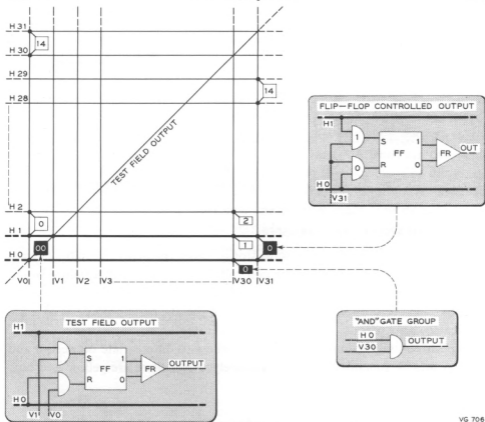

FIG. 7-5. Matrix, FF Groups 00 through 31.

VG 706

cial diode-resistor AND gate packages. The outputs (a +22v pulse) from this group activate electronic circuits in other units of the system.

The SD is a kind of buffer between the CC and the relays in the trunks. It accepts very fast signals from the central control and transmits them to the slower speed devices. Let's take an example to show how the signal distributor acts as a buffer. The central control recognizes a request for service to out-pulse on a trunk. It sends an address to the SD to seize a particular idle outgoing trunk. Then it carries out its other office duties. Now the central control returns to the SD to have it operate and release the trunk relay at the dial pulse rate. This relay generates dial pulses on that trunk. These pulses are sent to the distant office. This action is indicated by Fig. 7-6, on page 194.

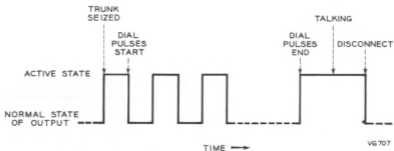

FIG. 7-6. Typical output from a point assigned to an outgoing trunk.

7.3 DUPLICATION AND TRANSFER

The failure of a diode or transistor in either the delay or enable circuits could affect all the circuits that are controlled by the SD. Such a failure would result in no enable pulse and could not be allowed for more than a few milliseconds. Therefore, to insure the reliability of the SD, certain portions of it are duplicated. This permits the transfer of duplicated units.

Duplicated units are marked blue and yellow to differentiate between 0 and 1, or A and B, functional units, respectively. Also, there are yellow and blue

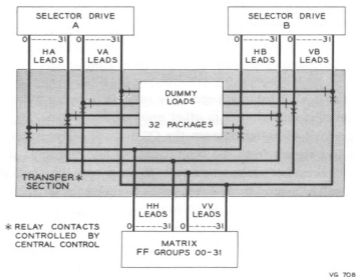

FIG. 7-7. Signal distributor, transfer of duplicated equipment.

trouble lamps. The lighted lamp always shows which unit can be worked on. If no lamps are lighted, both units are OK.

The duplicated units are shown as selector drives A and B in Fig. 7-7. The circuits of the selector drives are shown in Fig. 7-4.

When selector drive A is used for service calls in the system, selector drive B is in the stand-by condition, and vice versa. For example, let us assume that selector drive A is being used for service calls. Under this condition, the relays associated with the contacts that control the HA and VA leads are operated, and the information from selector drive A goes to the outputs. The relays associated with the contacts that control the HB and VB leads are released, so selector drive B output leads work into the dummy loads. The dummy loads insure that the selector drive in the stand-by unit is fully loaded for testing. The dummy loads are about the same as the loads presented by the flip-flop groups.

Now let us assume selector drive B is used for service calls. The central control starts a transfer signal that releases the relays controlling the leads of selector drive A. Also, it operates the relays controlling the leads of selector drive B. Selector drive B selects the outputs of the SD, and selector drive A works into the dummy loads.

7.4 POWER

There are two office power supplies used by the signal distributor, 230 volts alternating current and -48 volts direct current. The -48 volts is used for the operation of the transfer relays and to light lamps; the 230 volts is used to supply the rectifiers mounted in the front bay of the cabinet, as shown in Fig. 7-2. Since there is a duplication of equipment throughout the office, the office battery to the SD is supplied on two buses, B and C, for both office supplies.

The rectifier units marked A and B, mounted on the front bay, are supplied the 230v by office buses C and B, respectively. The rectifiers marked -16A, +22A, and +16A supply power for all the duplicated units marked A. The rectifiers marked B supply all the duplicated units marked B.

The two vertical columns of rectifiers from C and D up are also supplied by the 230-volt B and C buses. Looking at Fig. 7-2, the left column of rectifiers marked -16C, +16C, -16E, +16E, -16G, and +16G are supplied by the 230v B bus. The right column marked -16D, +16D, -16F, +16F, -16H and +16H are supplied by the 230v C bus.

The two vertical columns of rectifiers from C and D up have paralleling units associated with them. These have the same voltage designation as the rectifiers: for example, -16C rectifier, -16C paralleling unit; and -16D rectifier, -16D paralleling unit. These four units work together to supply -16v to mounting plates 100-109 on the rear bay of the cabinet. When a trouble occurs in one of the rectifiers, assume -16C, it is detected by the paralleling unit associated with it, and a lamp in the paralleling unit C is lighted. There is no interruption of power because the paralleling units C and D are in parallel, and the D rectifier supplies the power needed for the circuit. The -16C rectifier may be turned off (by a switch on the unit) and replaced very easily. The +16 C and D units also supply power to mounting plates 100-109.

The power units +16E and +16F, and -16E and -16F, supply power to the equipment on mounting plates 110-119; and the power units +16G and +16H, and -16G and -16H, supply power to the equipment on mounting plates 120-129. All these groups of units work in the same manner as explained for units C and D.

7.5 MISCELLANEOUS

Reset Switching Relay—Fig. 7-2

The reset switching relay determines the state of all the flip-flops that control outputs when the power is first turned on. The operation of this relay puts all these flip-flops in the reset state. This means that no outputs are active.

Test Fields A and B—Fig. 7-5

The test fields are outputs used only for testing the SD and the scanner. They form a diagonal line in the matrix, and therefore check each vertical and horizontal line in the matrix. By addressing the SD to these outputs, the central control can check the operation of the SD and the scanner.

A diagnostic test program, addressing the test field outputs, detects any trouble in the SD, other than single output troubles in the matrix. The diagnostic testing locates trouble in that section of the SD (a selector drive) where a trouble would cause many false outputs. The other selector drive is then switched into service, and the trouble cleared in the out-of-service selector drive.

Single output troubles in the matrix are detected by recognizing a failure in the circuit assigned to that output. When a trouble is detected, it can easily be cleared by replacing one or more of three packages associated with that output.

The assignment for all of the outputs of the SD are shown on ES-1A076-01, Signal Distributor Flip-Flop Group Lead Assignments—Morris. The circuit drawing for the Signal Distributor is ES-1A013-01.

AND Gate Group 30—Fig. 7-5

AND gate group 30 is a group of outputs activated by AND gates. The output signal is a +22v pulse. It is used to set or reset flip-flops in other electronic circuits in the ESS.

The flip-flop groups 30A and 30B, though they are outputs, are duplicated for reliability purposes. When the A side of the selector drive unit is in service, flip-flop group 30A is used. When the B side of the selector drive unit is in service, flip-flop group 30B is used. The AND gate group is used by both selector drive units, because it is not duplicated. Either the FF group is used or the AND gate group is used, never both or a combination of the two.

Chapter 8

The Barrier Grid Store

Storing information isn't new to the telephone art. The first operator to put up a switchboard connection remembered the number called for, long enough, at least, to search it out in the switchboard multiple and to make the connection. After this single task was completed, the operator erased the number from her memory and was ready for the next call.

Relays are used to duplicate the operator's memory in present-day dial telephone switching systems. They count pulses and store digits during the dialing phase of the call. After the digits dialed are analyzed and the connection is set up, the relays are released and ready to accept an entirely new set of pulses and digits.

8.1 DESCRIPTION OF THE BARRIER GRID STORE

In the ESS, the barrier grid store (BGS) provides the erasable memory. It has a cathode-ray tube with a mica plate target on which electrostatic charges are stored. The tube is known as the barrier grid tube (BGT). When the electron beam deposits a minute pile of electrons (an electrostatic charge) on the target, a one (1) is stored; where there is no electron pile (no electrostatic charge), a zero (0) is stored. Each memory cell (spot) may be compared to a relay. A "1" represents an operated relay; a "0" represents a released relay. The BGS can produce 16,384 memory cells on the mica plate, each capable of storing a 1 or a 0.

Figure 8-1 shows how the central control (CC) and the barrier grid stores (BGS's) are interconnected. Four BGS's furnish the temporary memory for the ESS. Two stores are always active and two are in stand-by condition under normal operations. The CC directs the BGS, via the control leads and the stand-by transfer, to one of the 16,384 spots on the mica plate. Also, it orders the BGS

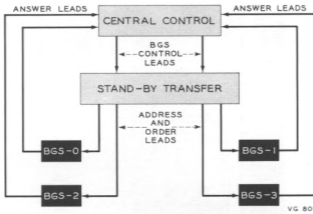

FIG. 8-1. Central control and barrier grid store interconnections.

to “read” or “write.”* When the CC sends a “read” order to the BGS, the answer, 0 or 1, is returned to the CC over the answer leads.

8.2 EQUIPMENT ARRANGEMENTS

Each BGS is a two-cabinet self-contained unit; one such unit is shown in Fig. 8-2. The power cabinet, BGP-0, contains eight plug-in rectifier units, as well as the alarm and control circuits. The storage cabinet, BGS-0, houses the barrier grid tube, the electron-tube packages, the plug-in chassis units, and miscellaneous other packages. All these devices are needed to operate the barrier grid tube (BGT) as a memory unit.

8.2.1 BGS-0, Front Bay (Fig. 8-2)

A hinged plastic door covers the front of the storage cabinet; in addition, a metal door covers the plastic door. The plastic door protects the packages. Also, it helps to distribute the cooling air uniformly through the cabinet even though the metal door is open. Holes in the plastic door permit access to the equipment for adjustment.

*In the language of electronic computing devices, to “read” means to obtain information from a memory unit, and to “write” means to insert information into a memory unit. In the BGS, an electron beam is used to determine the state of charge on a spot in the mica “memory” plate. This is the way we “read” a spot, or obtain information from the BGS memory unit.

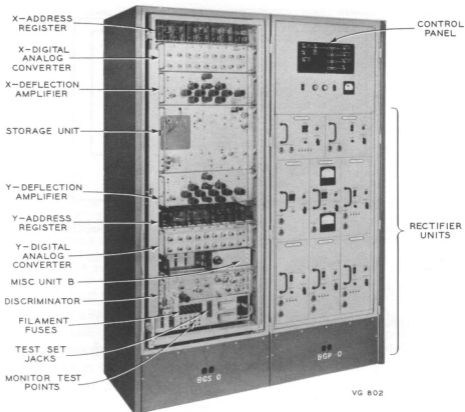

FIG. 8-2. Barrier grid store and power cabinets, front view.

The plug-in chassis have handles. These are adjacent to the locking levers that secure the chassis to the mounting plates. Connectors on the back of each chassis engage plugs on the mounting plates. These connectors carry power and signal leads to each unit.

Above and below the storage unit are the X and Y address and deflection systems. These two systems position the electron beam in the BGT. The storage unit houses the BGT, the raster reference tube (RRT), and the circuits that must be mounted near these tubes.

The miscellaneous unit B has a variable delay line and some minor components. Two packages are mounted on the plate adjacent to the B unit.

A discriminator, which determines whether a 1 or a 0 was read at a spot, is mounted above the test monitor. Connectors for test sets, monitor jacks, and filament supply fuses are mounted on the monitor plate.

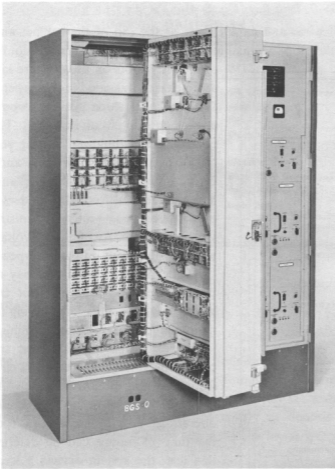

FIG. 8-3. Barrier grid store, gate bay. VG 803

The Gate Bay—Fig. 8-3

The equipment in the front bay is gate-mounted to permit access to the wiring side of both the front and the rear bays. Fig. 8-3 shows the gate bay swung out. Air, supplied through adjustable grilles, flows through the cabinet and is vented out the top. Interlock switches and gate locks are mounted on the edge of the gate.

8.2.2 BGS-0, Rear Bay (Fig. 8-4)

All wires and cables enter at the top of the cabinet and terminate on the terminal strip. Manual and automatic controls for positioning the array of memory spots on the BGT are located in the servo chassis indicated in the upper part of Fig. 8-4. The next three positions contain the sequence control circuit packages. These circuits control the reading and writing sequences.

A group of voltage dividers and their indicator lamps are located in miscellaneous unit A. Voltages derived from the dividers on the BGS d-c supplies are sent to the administration center voltage monitor. Any detected voltage variation will be printed out on the teletypewriter.

At the bottom of the rear bay are filament transformers and marginal test transformers. When trouble occurs, and during a preventive maintenance program, the administration center, through the marginal test transformers, causes the voltage on a selected circuit to vary from a normal value. While the voltage is varying, the circuit is given a series of timed test operations. If a failure occurs, the voltage at the time of failure can be determined. With this test, the system detects a weak package, which can be replaced before it causes an in-service trouble. Of course, preventive maintenance tests cannot be made on active equipment.

The packages used in each BGS are listed in Table 8-1.

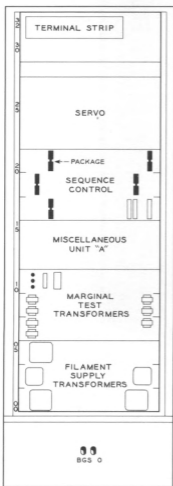

FIG. 8-4. Barrier grid store, rear equipment.

8.2.3 BGP-0, Front Bay

The location of the equipment in the power cabinet is shown in Fig. 8-2. The power features are described in Sec. 8.6 on page 223.

TABLE 8-1. PACKAGES USED IN EACH BARRIER GRID STORE

F-Spec. No.	CPS* No.	Quantity	Name
F-52704	28	5	OR Gate
F-52703	8	1	AND Gate
F-52702	37	21	Flip-Flop
F-52705	160	1	Blocking Oscillator
F-52717	159	2	Blocking Oscillator
F-52610	165	1	Back Plate Driver
F-52716	179	1	Pulse Monitor
F-52977	35	10	Input Buffer

*CPS means Circuit Package Schematic.

8.3 APPARATUS ELEMENTS

8.3.1 The Barrier Grid Tube (BGT)

The barrier grid tube (BGT) is a cathode-ray tube with a mica plate target instead of a phosphor screen target. A photograph of the BGT is reproduced in Fig. 8-5, and a schematic diagram of its structure is shown in Fig. 8-6.

An electron beam is used in the BGT to remove or deposit electrostatic charges on the mica plate (Fig. 8-6). When a "1" is to be written, the back

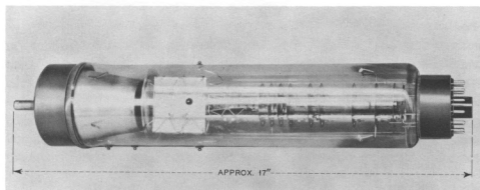
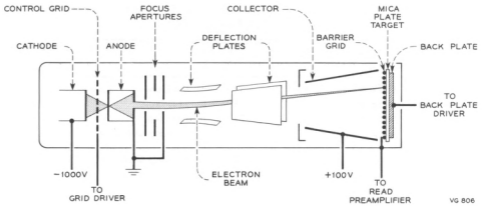

FIG. 8-5. Barrier grid tube.

VG 805



VG 806

FIG. 8-6. Barrier grid tube elements.

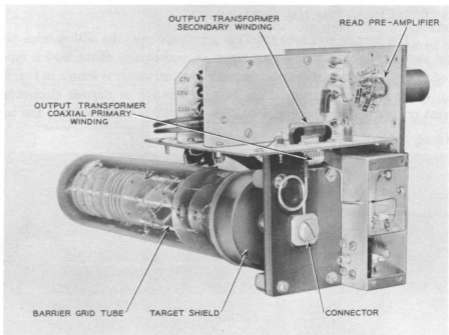

VG 807

FIG. 8-7. Barrier grid tube and read pre-amplifier.

plate potential is raised above the barrier grid potential while the electron beam strikes the target. After a short interval, both the back plate and the control grid are shut off, leaving an electrostatic charge on the mica plate.

A "0" is written with the back plate at ground potential. No electrostatic charge remains on the plate when the control grid is shut off.

When the beam strikes the target to read a spot, current flows to or from the barrier grid. This current in the output transformer primary produces a low secondary voltage at the read pre-amplifier input. After additional amplification, the signal feeds a discriminator which produces the 1 or 0 output.

The read pre-amplifier and BGT are shown in Fig. 8-7.

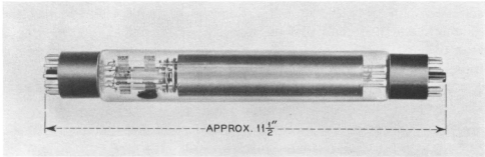

FIG. 8-8. *Raster reference tube.*

VC 808

8.3.2 The Raster Reference Tube (RRT)

The raster reference tube (RRT), shown in Fig. 8-8, is also a cathode-ray tube. A schematic of the RRT is shown in Fig. 8-9. The RRT has four pairs of over-lapping plates for the target. Each pair of plates has a reference edge that is positioned to correspond to an edge of the raster* in the BGT.

Periodically the system deflects the RRT electron beam to these reference edges. If there is a raster size or centering error, it is detected by the over-lapping plates and their associated circuits. A voltage is developed to correct the error; this voltage is sent to the address and deflection circuits. Since both

*A "raster" is a predetermined pattern of scanning lines that provide a uniform covering of a specified area.

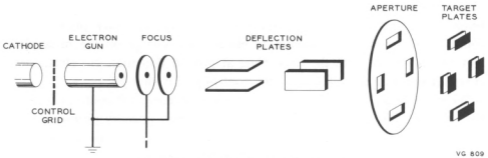

FIG. 8-9. Raster reference tube elements.

VG 809

the RRT and the BGT are driven by the same deflection amplifiers, any raster adjustment affecting the RRT will also appear in the BGT. In this way, the spots in the BGT are held to a pre-adjusted spacing, and the square array is kept centered within the target area. Figure 8-10 shows the relationships between the target plates in the RRT and the BGT.

A rear view of the storage unit, Fig. 8-11, shows the BGT shield, the RRT, and associated components.

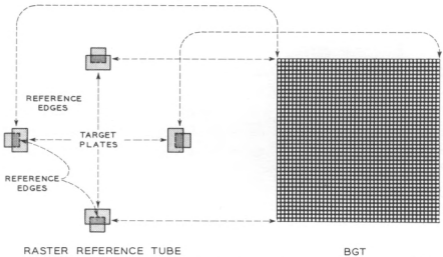

FIG. 8-10. Relation of reference edges in RRT to raster in BGT.

VG 810

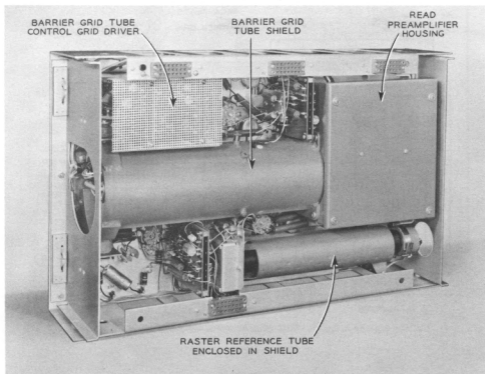

FIG. 8-11. Barrier grid storage unit, rear view.

VG 811

8.4 METHOD OF OPERATION OF THE BGS

The barrier grid tube and its control circuits are shown schematically in Fig. 8-12 on page 208.

An address circuit converts the fourteen-bit binary pulse address from the CC to a deflection voltage that positions the electron beam on the target.

A sequence control circuit receives an order from the CC and directs the read amplifier, back plate, and control grid in the correct sequence to carry out the order.

8.4.1 Address and Beam Positioning

The vertical address and deflection circuits are shown in the schematic diagram of Fig. 8-13.

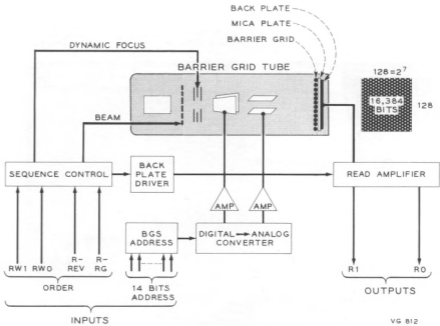

FIG. 8-12. Barrier grid store, control circuits.

An address is brought over from the CC via coaxial cables to the input buffers. Cables from a test jack also terminate here. This jack provides access by a test set to the BGS address circuits.

The input buffers convert the 0.3-microsecond pulses from the CC to the 0.1-microsecond pulses required by the address register flip-flops.

The BGS takes an interval of time to perform its functions. Therefore, the address is held in the address register flip-flops while an order is executed and until the BGS receives a new address.

The address register output appears on seven pairs of leads; each pair has +5v on one lead and -13v on the other lead. This combination of voltages cannot directly drive the BGT deflection system, so the digital address is changed to an analog voltage in the digital-to-analog converter (DAC).

The DAC is a set of vacuum-tube diode switches that are operated by the address register flip-flops. These diodes switch currents determined by the resistors in their anode circuits. The resistance values are different for each

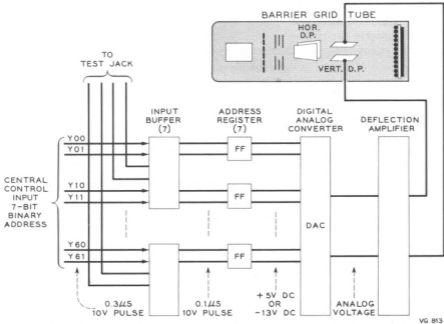

FIG. 8-13. Barrier grid store, vertical address and deflection circuits.

switch. A low-value resistance is in the switch operated by the most significant digit flip-flop, No. 6, while the highest resistance value is in the switch operated by the least significant flip-flop, No. 0. Changing the state of flip-flop No. 6 causes the electron beam to move a distance equal to one half raster. If the state of flip-flop No. 0 is changed, the beam moves to an adjacent spot.

The output of the DAC drives the deflection amplifier; the deflection voltage that results is applied to the BGT and RRT deflection plates. This positions the electron beam for the vertical axis. An identical system generates the deflection for the horizontal axis.

8.4.2 The Sequence Control

The orders from the CC are received by the sequence control, which is shown schematically in Fig. 8-14. In normal operation, each address is accompanied by one of the following orders:

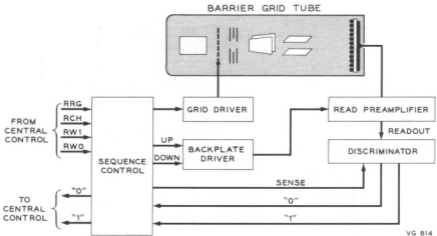

FIG. 8-14. Barrier grid store, sequence control.

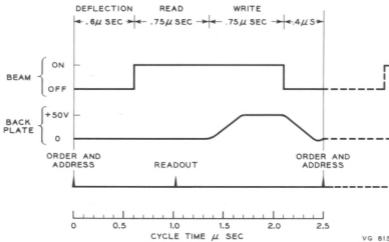

FIG. 8-15. Barrier grid store, operation cycle.

<i>Order</i>	<i>Abbreviation</i>	<i>Meaning</i>
Read—Regenerate	RRG	Read a spot, and regenerate it (that is, replace the charge on that spot to overcome the effects of decay, including any charge lost in the operation of reading it).
Read—Change	RCH	Read a spot and change its state, either from 1 to 0 or from 0 to 1.
Read—Write 1	RWI	Read a spot and, no matter what is there, write a 1. (This order is also used simply to write a 1.)
Read—Write 0	RWO	Read a spot and, no matter what is there, write a 0. (This order is also used simply to write a 0.)

The grid driver, shown as part of Fig. 8-14, pulses the BGT control grid on and off, and thus controls the electron flow toward the target. The back plate driver raises and lowers the back plate potential by 50 volts. The back plate potential is +50v when a 1 is being stored, and at ground when a 0 is being stored.

The read preamplifier and the discriminator together amplify and determine the BGT output. The 1 and 0 output signals are not all equal in amplitude; the discriminator is adjusted to a marginal area and produces a fixed output for each read-out. The discriminator output is sent to the CC. It is also combined with the *read—change* and *read—regenerate* orders in the sequence control circuit to raise the back plate potential, if a 1 is to be written.

A BGS operation cycle is shown in Fig. 8-15. The diagram charts the sequence of operations and shows the time required for each.

8.5 REGISTERS

The BGS memory spots are grouped to form various call and control registers for the ESS. Twenty-nine types of registers are listed in Table 8-2, which also tabulates the number of registers of each type, the number of memory spots per register, and the symbolic abbreviation for each. The quantity of spots per register varies with the different kinds of registers; the number of spots assigned to a register is determined by the amount of memory required for each register to perform its task. The number of customers served and their

TABLE 8-2. REGISTERS IN THE BARRIER GRID STORES

Number of Registers	Memory Spots per Register	Name of Register
12	64	Originating Register (OR)
8	42	Ringing Register (RR)
4	21	Disconnect Register (DR)
6	39	Incoming Register (IR)
6	88	Outpulsing Register (OPLR)
4	37	Reverting Register (RVR)
4	14	Blocked Dial Tone Register (BDTR)
35	16	Operator Trunk Register (OTR)
4	38	Operator Dialing Register (ODR)
4	32	Operator Disconnect Time Register (ODTR)
1	28	Operator No-Test Register (ONR)
2	63	Test Desk Register (TDR)
4	38	Bridged Extension Register (BER)
20	128	Full-Dial PBX Call Register (FXCR)
64	104	Half-Dial PBX Call Register (HXCR)
8	112	Supplementary PBX Call Register (SXCR)
8	141	PBX Attendant Register (XAR)
2	5	PBX Tie Line Register (XTLR)
64	11	Indicator Status Register (ISR)
6	33	Indicator Control Register (ICR)
6	32	PBX Reference Register (XRR)
1	128	Main Program Register (MPR)
1	256	Network Register (NR)
1	64	Translation Register (TR)
1	16	Regeneration Register (RER)
1	576	Diagnostic Register (DIR)
1	1112	Traffic Count Register (TCR)
1	192	Teletypewriter Register (TTYR)
1	128	FSS Exposure Register (FSXR)

calling habits determine how many call registers the system should have. Some of the registers are in use on every call, for periods of less than a second; the dialing registers are needed for perhaps 20 seconds on a call; the ringing registers, 5 minutes at the most. The main program register is always in use, since it is used to coordinate the entire system operation.

Since two barrier grid stores are needed to supply enough spots for all the registers and the administration data, this information is split up between them. About half of the registers appear on the left side of each BGT, and half of the administration information on the right side of each tube. This is shown in Fig. 8-16 for line and register tube zero (LRT-0), and in Fig. 8-17 for line and register tube one (LRT-1). The active stores are referred to as LRT-0 and LRT-1; the associated stand-by stores are referred to as SB-0 and SB-1.

The CC sends the same address to all four BGS's. It sends an order to one or more of the BGS's as specified by the system.

The BGS's can be operated in either a multi-tube or a single-tube mode. In the multi-tube mode, an order may be sent to all BGS's; in the single-tube mode, to only one in-service BGS and its stand-by BGS. During diagnostic programs, the active and stand-by tubes are read independently, and their respective readings are matched to detect errors. The circuits that control these operations are in the CC and are explained in detail in Chapter 10, *The Central Control*.

The normal operating mode of the BGS is shown in Fig. 8-18. When the system is operating with the four BGS's, the answers from each active store are matched with the answers from its stand-by store. If the answers do not match, the system enters a fault-checking routine to determine which store gave the incorrect answer. During this time, the system does not process calls but directs its entire facilities to isolating the unit in trouble (talking connections are not affected). The system determines which stand-by store will take over the active status, if an active unit fails. It also switches one of the stand-by stores to split-tube operation, as shown in Fig. 8-19. Here we see the positions to which the tubes are assigned for several trouble conditions. A single-trouble mode (a failure of BG-3) is diagrammed in (B) of Fig. 8-19. To meet this situation, BG-2 is split so that it stores administration information from BG-0 in its left half and administration information from BG-1 in its right half. You can see that BGS answer matches are limited to BG-1 administration information.

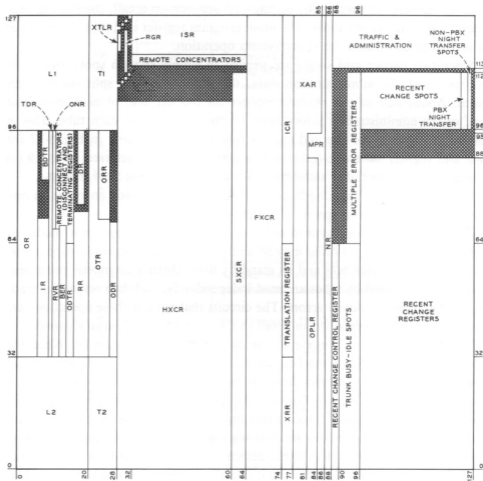

VG 816

FIG. 8-16. Barrier grid store, register layout LRT-0.

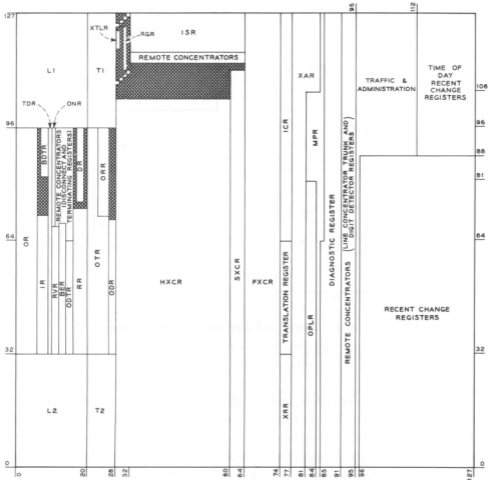

VG 817

FIG. 8-17. Barrier grid store, register layout LRT-1.

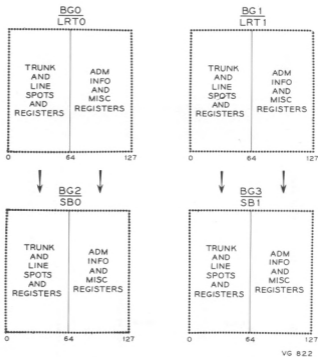

FIG. 8-18. Barrier grid store, normal operating mode.

Immediately upon switching out a faulty unit, the system returns to the task of handling calls. During diagnostic program time, the administration information is copied from the active BGS to the split BGS. When copying is completed, the split tube is ready for system use. The fault-check routine and switch require less than two-tenths of a second (0.2 second) to complete.

The BGS that failed is now given a series of diagnostic tests that pinpoint the source of trouble within the unit. Teletypewriter print-outs indicate the test that failed. The diagnostic dictionary is used to translate the teletype message to equipment that must be replaced.

After a BGS has been repaired, a request to return it to its normal system position is started through the teletypewriter. The information to be stored is copied from the active store or stores. When this is completed, the store returns to system use.

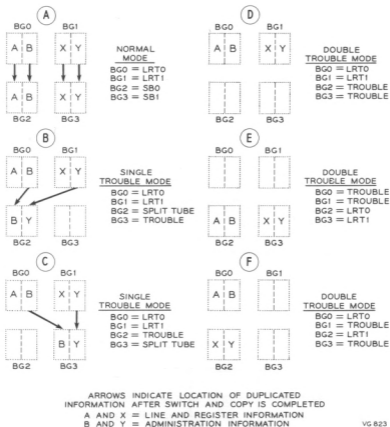

FIG. 8-19. Barrier grid store, operating modes under various abnormal conditions.

8.5.1 Register Description

A brief description of some of the functions of a few BGS registers is given below.

Line and Trunk Supervisory Register

One of the functions of the ESS is to recognize supervisory signals. Service requests and disconnects are supervisory signals. The scanner can only tell when a line is off-hook or on-hook. Therefore, some memory is provided to

TABLE 8-3. LINE SPOT MEMORY ASSIGNMENTS

State of Line Memory Spot		Condition or State of Line
L1	L2	
0	0	Idle Line on-hook
0	1	Served by Register Customer dialing Served by originating register Calls to No. 5 crossbar served by outputting register Ringing Called lines served by ringing register
1	0	Talking Connection set up through distribution switching network

VG 819

TABLE 8-4. SYSTEM ACTION DURING SUPERVISORY SCAN OF LINES

Scanner Output	Line Memory Spots		State of Line	System Action
	L1	L2		
0	0	0	On-Hook	No system action.
1	1	0	Off-Hook	No system action.
1	0	0	Off-Hook	Memory indicates that the line was idle during last scan. Assign originating register, and change memory spots to L1=0, L2=1.
0 or 1	0	1	Off-Hook or On-Hook	Memory indicates system is processing information coming in from this line. No system action.
0	1	0	On-Hook	Memory indicates talking during last scan. Assign disconnect register, and change memory spots to L1=0, L2=1, until disconnect is completed; then change to L1=0, L2=0.

VG 820

TABLE 8-5. TRUNK SPOT MEMORY ASSIGNMENTS

State of Trunk Memory Spot			Condition or State of Trunk
T1	T2	T3*	
0	0	0	Idle
0	1	1	Signal (Dialing)
1	0	1	Talking
0	0	1	Busy Trunk not assigned. Trunk busy for maintenance. Trunk seized prior to register assignment.

*If a T3 spot is assigned to the trunk.

VG 821

enable the system to detect these line changes. Two line memory spots are assigned in the BGS to each line in the office. These are the L1 and L2 spots. The spot states are changed when the line goes from on-hook to off-hook; when the customer is dialing; when the customer starts talking; and when the customer disconnects. The states of the L1 and L2 spots for various line conditions are shown in Table 8-3.

The system action, as a result of comparing the scanner output and associated line spots, is shown in Table 8-4. The supervisory scan of all lines is performed by the system ten times every second.

Trunks which have been assigned T1 and T2 spots are scanned in a similar manner, and the spots are altered to agree with the states of the trunk. A T3 spot is assigned to each trunk within a group of trunks. Dial tone, ringing, and outgoing trunks are examples. These spots are used when the system is hunting an idle trunk within a group. Incoming trunks do not have T3 spots because the ESS does not select a trunk of this type. The states of the T1, T2, and T3 spots for various trunk conditions are shown in Table 8-5.

Originating Register (OR)

- (1) Records all call originations.
- (2) Records dial pulses except on intra-PBX-WP calls.
- (3) Recorded digits are used to analyze the call type and to translate the directory number to an equipment number.
- (4) Advance the control to another register to complete the call.

Ringin Register (RR)

- (1) Controls the call during ringing and until the called line answers.
- (2) Through the scanner, detects answers.
- (3) Times the maximum ringing periods: 5 minutes for non-PBX calls, and 45 seconds for attended CGS calls.
- (4) Not used on calls to No. 5 crossbar or EAS offices.
- (5) Released when talking connection is set up.

Disconnect Register (DR)

- (1) Controls the release of lines that have returned on-hook after a connection was set up in the system.
- (2) Times for line hits and disconnects.

Incoming Register (IR)

- (1) Detects, counts, and stores the digits dialed over incoming trunks (the last four digits).
- (2) Advances control to the ringing register, RR, for call completion.

Outpulsing Register (OPLR)

- (1) Controls digits outpulsed to a connecting office.
- (2) Digits from lines recorded by the OR are transferred to the OPLR.
- (3) Records four digits for each call to the No. 5 office, and seven digits for calls to EAS offices.
- (4) Timing spots in the OPLR, as well as in the program, control various timing intervals during outpulsing.

- (5) Starts a scan of the calling line prior to the last digit to determine whether the line is off-hook. If the line is on-hook, the OPLR and the line are released, and the No. 5 crossbar register times out.

Reverting Call Register (RVR)

- (1) Receives eight digits from the OR, and controls the call until an answer is detected. No network talking connection is set up for a reverting call.
- (2) Times 3.5 minutes; if no answer, the connection is released.

Blocked Dial Tone Register (BDTR)

- (1) Times for retrials to dial tone connection for lines that have been blocked in the concentrator and distribution switching networks.
- (2) The OR must be available before a connection is set up on retrieval.

Operator Trunk Register (OTR)

- (1) An OTR is permanently assigned to each operator trunk, permanent signal trunk, partial dial trunk, and denied service trunk. It provides memory for the various trunk and associated line states.

Operator Dialing Register (ODR)

- (1) Action similar to incoming register.
- (2) Seized after a timed start by an operator disconnect timing register.
- (3) The operator may dial a single-digit-directing code for no-test calls.

Bridged Extension Register (BER)

- (1) Extensions on non-PBX lines are interconnected via BER action.
- (2) Translation after the second digit in the OR, for lines with bridged extension service, will result in the BER being assigned to the call.
- (3) A code plus extension number is dialed.
- (4) Detects hang-up, time-out, and answer.
- (5) Controls code ringing; no distribution switching network connection required for talking.

Operator Disconnect Timing Register (ODTR)

- (1) Times for switchhook flashes and disconnects. Also times a start-dial interval from operators.

Test Desk Register (TDR)

- (1) Works with the test trunks from the ESS local test cabinet to the distribution switching network.
- (2) Stores a directing digit 2, plus a four-digit directory number for no-test calls.
- (3) Stores a directing digit 4, plus a four-digit line selector address for line circuit test calls.
- (4) Stores a directing digit 5, plus a five-digit network selector address for a trunk test.
- (5) Stores a directing digit 3, plus the five-digit network selector address for camp-on-busy connection. If a trunk is busy, the TDR starts half-second scans until the trunk becomes idle, and then seizes it.

Main Program Register (MPR)

The main program oversees ESS operation. It allots time intervals to the routines and programs which are necessary to process calls and to operate the system. Some system jobs are more important than others and must be completed at regular intervals. The main program is, in a sense, the priority list for these operations, and the MPR is the time keeper.

Network Register (NR)

The NR is a buffer between the CC and concentrator and distribution switching networks (CSN and DSN). When the network is given a job, the NR records the information needed for the job; it oversees this operation until it is completed.

Translation Register (TR)

Called on when a translation is made on originating and terminating lines.

Regeneration Register (RER)

The barrier grid stores must be regenerated at regular intervals to maintain accurate information. A regeneration program in the FSS specifies how the tube should be regenerated; the RER acts to administer this program.

Diagnostic Register (DIR)

Called upon to administer diagnostic programs, if a trouble occurs in the system.

Teletype Register (TTYR)

A buffer is required between the CC and the teletypewriter because of the difference in speed and operation. The TTYR buffers all messages in and out of the system via the teletypewriter.

8.6 POWER

The d-c power for each BGS is supplied from eight plug-in rectifier units in its associated power cabinet (BGP) (refer to Fig. 8-2). The a-c power for the four power units is fed from the regulated 230v a-c buses as follows:

Bus A: BGP-0

Bus B: BGP-1

Bus C: BGP-2, BGP-3

The eight rectifier units supply negative and positive regulated d-c voltages for the BGS circuits.

A 48-volt source is required for the control circuit relays. It is supplied from the central office battery as follows:

Bus A: BGP-0

Bus B: BGP-1

Bus C: BGP-2, BGP-3

8.6.1 Power Control

The control circuit, Fig. 8-2, in the top of the BGP applies a-c power in three steps. This brings the vacuum-tube filaments up to operating temperature before the d-c voltage is applied. The sequence takes about 130 seconds.

The d-c output switch, in the test position, delays application of the d-c power to the BGS. When this switch is later operated to the normal position, the d-c is switched to the BGS after a ten-second delay.

Red lamps indicate failures; white lamps indicate normal conditions. When all control and power voltages are available, the white lamps are lighted; a failure will bring in alarms and light a red lamp to indicate the source that failed.

8.6.2 Rectifier Units

All but the -15v rectifier unit are automatically regulated. The regulators keep the output constant by compensating for minor variations in input voltage and load.

Each rectifier unit has its own high-low voltage alarm circuit. This alarm circuit provides a signal when the voltage is 10 per cent high or 25 per cent low. To test the alarm, you operate the test switch to either the high or the low position. This raises or lowers the voltage to the alarm circuit only. If the alarm lamp lights, the circuit is OK. In normal operation, high-low alarm relays provide a holding path in the control circuit. If one of them operates, the hold path is opened and the entire power cabinet is shut down.

Rectifier units may be removed from the cabinet for maintenance after the power connectors and locking devices at the rear of the cabinet have been opened.

An interlock on the rear door opens the start and operate path in the control circuit.

8.7 MAINTENANCE

Maintenance of the BGS's is simplified because most of the testing is done by the system. The testing procedures include matching the BGS outputs, as well as fault-checking and diagnostic programs. The test results are printed out by the teletypewriter in the administration center. You look up the definition of the print-out in the maintenance dictionary, and then do whatever is necessary to restore a faulty unit to service.

When the outputs of the active and stand-by BGS's do not match, the system determines, through a fault-checking program, which unit gave an incorrect output. If both units pass a series of tests, the mismatch is considered an error. A print-out records the address of the error and the units involved.

A print-out reporting trouble follows the general form shown by the example at the top of page 225:

▲ ERROR BGSXX XXX XXX

▲ = trouble report.

BGSXX identifies the units in which the error occurred.

XXX XXX gives the BGS address at which the mismatch occurred.

When a unit fails to pass the fault-check test, it is removed from service, and a print-out like the following is produced by the teletypewriter:

▲ FT PX BGSX

▲ = trouble report.

FT means a mismatch due to a fault.

PX indicates the fault-check test that failed.

BGSX identifies the unit that failed.

After the faulty unit has been given a series of diagnostic tests, the specific location of the fault, together with other pertinent information, is given on a print-out like the following example:

▲ DBX C XXXXXX

▲ = trouble report.

DBX indicates the unit which was given the diagnostic tests.

C indicates the test on which the failure occurred.

XXXXXX is coded information which, when translated with the aid of the maintenance dictionary, indicates the packages or chassis to be replaced. The translation may, in some instances, indicate the need for minor adjustments.

The teletypewriter print-out, the lamps in the administration center, and the alarm lamps in the BGS cabinet—all indicate which BGS is out of service (made busy).

Packages in the BGS can be replaced without additional adjustment. When certain chassis are replaced, however, you may need to adjust various controls. Specification X-63953 outlines the procedures to be followed for this and other detailed maintenance in the BGS. Additional maintenance procedures are included in Specification X-63941.

CAUTION Before replacing any packages or chassis units in the BGS, shut down the BGS power by operating the BGS power control STOP button.

Chapter 9

The Flying Spot Store

The Flying Spot Store (FSS) is the semipermanent memory of the ESS. In it are stored all of the instructions that tell the system what to do for every possible call condition and for every possible system situation. These stored instructions include program and translation information. This information is stored in a pattern of transparent and opaque spots on photographic plates. Light beams from one spot of light on the face of a cathode-ray tube (CRT) are directed by a lens system to read the information stored on the photographic memory plates. Wherever light passes through a transparent spot on the plate, a photomultiplier tube (PMT) behind the plate produces an electrical signal at its output. This signal is a binary "1." Wherever a light beam strikes an opaque spot on the plate, the PMT will see no light, and will read a binary "0." The same light beams that read information from a plate are used to write information on unexposed film plates for the FSS.

Two flying spot stores are used in the ESS. One of them is always active, while the other is in the stand-by condition ready to take over if the active unit is removed from service. The stand-by FSS is also used to prepare new photographic plates.

Figure 9-1 shows a typical information channel in the FSS.

9.1 THE FSS INFORMATION SYSTEMS

Each FSS contains two distinct information systems. One is used, as previously explained, to furnish program and translation information to the system. The other is used by the FSS to help position the electron beam of its CRT.

The program information is used by the central control (CC) to "spell out" system operation. The translation information is consulted by the system when a directory number is to be converted to an equipment number. It is also used

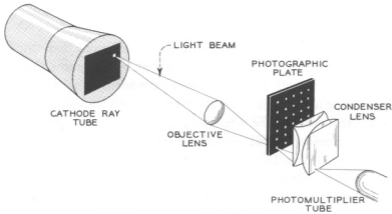

FIG. 9-1. *Flying spot store information channel.* VG 901

to determine a customer's class as well as his type of service and his ringing frequency. Programming and translation are described in Section 9.2.

The beam positioning information is derived from the servo code plates; it is used to determine the location of the CRT beam. Beam positioning is explained in subsection 9.5.2.

9.2 THE SYSTEM PROGRAM

The system program is divided into many sections, and each section deals with a separate phase of system operation. The sections are called the "main program," "subprograms," and "subroutines." Most of the sections are used to service customer calls on lines and trunks. Others care for internal system actions, trouble diagnosis, and maintenance routines.

The FSS has programs common to each group of call registers in the BGS (described in Chapter 8). For example, there are programs for the originating registers, the test-desk registers, and the traffic registers, to name a few. These registers are served on a time-sharing basis with all other registers, lines, and trunks, and with other system actions. The lines are scanned every 100 milliseconds (ten times per second); operator and incoming trunks are scanned at a

50-millisecond rate. Call registers are served more frequently because the lines and trunks associated with these registers are feeding information into the system or out of it.

Most of the registers, while active, are served by more than one program. The originating register, for example, is served by programs that deal with recording dial pulses, with partial-dial and permanent-signal timing, and with interdigital timing at periodic intervals. Network and translation programs are entered when requested by the originating register.

Why are so many programs needed for one register? Let us look at a relay system for a comparison. In a relay system, when dial pulses are coming in at a regular rate, a slow-release relay is held up. But when the pulses stop while the customer is setting up the dial for the next digit, the slow-release relay falls back. This causes a circuit transfer that signifies the end of a digit and at the same time prepares another circuit to receive the next series of pulses.

In the ESS there are no slow-release relays in the originating registers. Instead, an electronic method is used to determine the last of a series of pulses forming a digit. This is done by checking the originating register, or any dialing register, every tenth of a second. A separate program performs this check. It checks a counter (a group of spots) in the register that times the interdigital interval. As long as dial pulses are coming in at a regular rate, this counter is set to zero. When the dial pulses stop, the counter is free to advance. Each tenth of a second, when the register is served by the interdigital timing program, this counter is advanced. Interdigital time-out occurs when two-tenths of a second have elapsed. Then a subprogram is called into action to find an appropriate digit slot in the register, and to transfer the pulses in the pulse counter to this digit slot. Now this register is ready to receive the next series of pulses.

Permanent-signal and partial-dial timing is performed in much the same manner. When the digit counter shows that seven digits have been received, the system knows that a complete directory number has been dialed. Now it must find this number as it appears in the equipment so that a connection can be set up. Here is where the translation programs come into action. When the translation is completed, the network programs are called upon to set up a path through the concentration switching network and the distribution switching network.

From this you can see that calls and other system functions are completed by doing a whole series of small jobs. Similar small jobs are being done for other

calls in a sequential manner. All originating registers are scanned for one type of work operation at a time. The active registers get more attention from subprograms than the idle registers. After the originating registers have been served, the system examines the incoming registers, then the operator registers, and so on through the entire series. The more important jobs are completed first; those of lesser importance are completed near the end of the series. This is an example of the priority given to certain system tasks by the main program. Within each tenth-of-a-second interval the system runs through a complete program cycle. This interval is divided into ten segments, each ten milliseconds long. Within each ten-millisecond interval, all of the high-priority jobs are completed first; then portions of lower priority jobs are completed. During extremely heavy traffic loads, some of the low-priority jobs are put off until the following cycle.

The Main Program Sequences

The main program sequences are shown in the block diagram in Fig. 9-2. At the top is a 100-millisecond scale divided into ten-millisecond and one-millisecond intervals. The sequence shown below the scale begins at the upper left and progresses through the high-priority jobs toward the less important jobs in the lower right. A cycle begins at the start of each ten-millisecond interval, and ends at about the end of the tenth millisecond interval. This is repeated ten times during the 100-millisecond interval, after which the 100-millisecond cycle is repeated.

An index of the jobs to be completed during a ten-millisecond interval is included in the program along with an identifying job number. If the system is pressed for time because of heavy traffic loads, these jobs may be put off for a ten-millisecond interval or even longer. When time is again available, the index is consulted and the job at the top of the list is completed.

You will note that at frequent intervals in the sequence the nine-millisecond clock is checked. If nine milliseconds have elapsed since the beginning of the cycle, a ten-millisecond time check is made, and portions of the sequence are skipped. Also, the ten-millisecond time check is made more frequently toward the end of the cycles to assure that the system leaves the present sequence on time. An interval is never shorter than ten milliseconds, but it may be as much as several hundred microseconds longer.

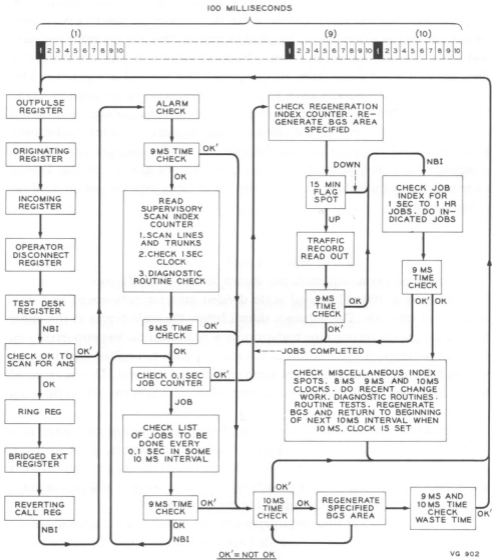

FIG. 9-2. Main program sequences.

The system can leave the main program to enter other programs to do jobs for the call registers, or for other reasons. Each program has a job index number. As each program is completed, the job index number is changed to correspond to the number of the job about to be entered. At the beginning of each ten-millisecond interval, this program job index is changed to show the number of the first high-priority job shown in the outpulse registers.

Among other jobs done between the blocks in Fig. 9-2 is the BGS servo check. At appropriate intervals, the program that cares for the servo check is entered. The job index reference spots indicate which edge of the BGS raster requires a check. One edge is checked every two milliseconds.

The letters NBI appear several times on the drawing, Fig. 9-2. This signifies a *network break-in*. During such an interval, the network break-in flip-flop is read. When the network completes a job, the markers set the network break-in flip-flop. When it is set, the system enters a network sequence, does whatever work is required, and returns to the main program as directed by the job index number.

If trouble occurs, all call-processing actions stop and a program is entered for locating and switching out of service the unit in trouble. When needed, other programs are entered which diagnose and pinpoint the source of trouble and perform maintenance routines. The main program allocates time for these jobs. Some may be performed hourly, some only once a day, and others on the demand of the maintenance craftsman through the administration center.

Decision Orders and Nondecision Orders

Each instruction in the program is called an "order word"; it specifies *what to do* and *where to go* to carry out the instruction. The order words fall into two categories, decision and nondecision.

The decision orders specify two alternative actions: either (1), proceed along a prescribed series of actions or (2) transfer to a new and different series of actions. These orders always specify a read or match operation—read the scanner, a flip-flop, or the barrier grid store; or match two binary words. The decision orders can be modified to specify a particular condition to be met, such as "transfer if a 1 is read"; or "proceed along the present series if a 0 is read;" or vice versa. The order may also specify which of two transfer registers (in the CC) should be used if a transfer condition results. The transfer register specified contains the address of the first word in the new program series to be

used in the event of a transfer. The address of the new series is placed in the transfer register upon entering the series initially.

Nondecision orders do not provide alternative actions; they simply specify a work operation. A few typical examples are:

- (1) Write a 1 or 0 at a specified BGS address.
- (2) Write a 1 or 0 in a specified F/F.
- (3) Read the BGS at specified address, and store the reading in a specified F/F.
- (4) Transfer to a new program address (no decision).
- (5) Gate (transport) information from a specified F/F group to a second F/F group.
- (6) Regenerate the BGS at a specified address.

The amount of information contained in the order word is not the same for all orders. Some orders are more complex than others and require more information in the *instruction* part of the order; others require more *address* information. For example, to address the BGS to a particular spot requires a fourteen-bit address. But since the registers in the BGS are arranged in columns and grouped, it is possible to modify the address part of the BGS orders and specify only one-half the address in the order. Some BGS orders will therefore specify that either the X or the Y half of the address be set up in the BGS address register located in the CC (pre-set address) before beginning a series of operations. If, for example, the system is working with an originating register, the X address of the register may be preset in the central control BGS address register. The orders which follow contain only the Y address of the spot or spots to be worked on.

Some orders require two addresses in the "where to go" part. Gating information from one flip-flop group to another, and from the BGS to a flip-flop, are examples of multiple address orders. The source and termination of the flow of information is specified.

By now you are no doubt wondering about the length of the word or instruction that carries all of this information. You may have the impression that the words are of different lengths because they carry different amounts of information to the system. In spite of such variations in the quantity of information carried, however, all the order words are of the same length; each instruction is a coded order word of nineteen bits.

There is a language difference between the ESS and its designers and maintenance people that must be overcome. While the ESS uses the binary number language with ease, it would be cumbersome for you to talk about its functions or to communicate directly with it, using its own language. Therefore, a coded language of symbols, letters, and numbers is used to abbreviate our rather long descriptions relating to system operations. This abbreviated language is changed to a series of numbers. These are then translated to the binary language, and finally put on FSS plates. There are a few special situations, however, that require you to communicate with the system in the binary form. These are the special tests started through the teletypewriter at the administration center.

The order word structure, and the conversion of a typical order from a detailed description to the binary equivalent on the photographic plate, are shown in Fig. 9-3. An order word is coded in four parts, and each part yields the following combinations:

The A Code: 3 Bits = 8 Combinations

The B Code: 3 Bits = 8 Combinations

The C Code: 5 Bits = 32 Combinations

The D Code: 8 Bits = 256 Combinations

The A, B, C, and D codes of the order are related to specific system operations. Coding the order in this way makes it easier to work with. The eight possible combinations of the A code are used to form the following seven types of orders:

- (1) Decision.
- (2) Nondecision.
- (3) Transfer.
- (4) Set up transfer register 1.
- (5) Set up transfer register 2.
- (6) Set up access register 0.
- (7) Set up access register 1.
- (8) *The eighth combination is not used.*

The B code is used to modify decision orders. It may also specify action when used alone or combined with the C code. The B code carries address information when a full sixteen-bit address is necessary. Transfer orders and set-up orders are examples of the types which require a sixteen-bit address.

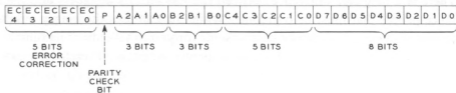
ORDER CODE:

1. INSTRUCTION PART - WHAT TO DO
2. ADDRESS PART - WHERE TO DO IT

DESCRIPTION OF A TYPICAL ORDER:

WRITE 1 IN THE BGS AT THE Y ADDRESS SPECIFIED BY THE CONTENTS OF D6 TO D0 AND THE ADDRESS GIVEN BY THE CONTENTS OF THE BGS ADDRESS FLIP FLOP GROUP

ABBREVIATED ORDER DESCRIPTION:

WRITE 1 AT Y, X PRESET

SYMBOLIC ORDER:

W1Y

DECIMAL EQUIVALENT:

A = 1, B = 7, C = 1, D7 = 0, D6 TO D0 = 6 (SPECIFIED ADDRESS)

BINARY EQUIVALENT AS STORED ON FSS PHOTOGRAPHIC PLATES:

FIG. 9-3. Order word structure.

VG 903

Address or action information is carried by the C code. The D code always has information which is, in a sense, an address. It may be the location of a particular memory spot, or it may specify a particular flip-flop in a flip-flop group. In many cases, the number specified in the D code identifies a single lead that is gated to a common "read" flip-flop* by the order. The common flip-flop is read to determine the state of the lead.

Order types, abbreviated order symbols, and coding are shown in Table 9-1 on pages 236, 237, and 238. There are 78 types of orders and about 65,000 words in the ESS program. In addition, storage space is provided for 16,000 translation words consisting of thirty-two bits each.

*A "read" flip-flop shows by its output the state of any of several input leads that may be gated to it.

Now let us go back to Fig. 9-3 and the order word structure for a moment. A parity-check bit and five error-correcting bits are attached to and recorded with each nineteen-bit word. The parity check bit may be either a 1 or a 0, and its state is dependent on the number of 1's in the order word. The number of 1's plus the parity bit must always equal an even number. The CC parity check circuits check each word for an even number of 1's. If an odd number of 1's is detected, the system enters a wired error-correcting program and uses the five error-correction bits to locate and correct the bit that is in error.

9.3 EQUIPMENT ARRANGEMENTS

The FSS and its associated rectifier units are mounted in five cabinets. The FSS bays are designated 0 through 6. The front and end bays have even numbers; the odd-numbered bays are in the rear. The packages used in each FSS are listed in Table 9-2 on page 239.

The rectifier units and power control circuits are mounted in the cabinets designated FSP-0 and in the lower half of FSS-0. The power sources, circuits, and controls are described in Section 9.6, *Power*.

9.3.1 Cabinet FSS-0, Front Bays (Fig. 9-4, page 240)

Let us begin the description of the bays with bay 2. The lower half of bay 2 contains the X and Y integrating amplifiers and the digital-to-analog converters. These plug-in chassis are locked to their mounting plates. The locking levers are located adjacent to the handles. Interconnections to other equipment are made through connectors on the backs of the chassis and the mounting plates. Air for cooling enters the cabinets through adjustable grilles at the bottom, and is vented out at the top.

The tops of bays 2 and 4 provide a chamber for the elements of the optical system. Also, at the top of bay 2 are the shutter control relays. These relays are operated from the administration center; they control the operation of the shutter solenoids.

You can view the face of the cathode-ray tube through the eyepiece to the left of the shutter control relays.

The lower half of bay 4 contains the packages that make up the address registers and the comparator circuits. The address leads from the CC terminate

(The text is continued on page 240.)

TABLE 9-1. ORDER CODING

Type of Order	Order Symbol	A	B	D7	Group I C	Group II D
Read the BGS	RY—	0	0-2, 4-6	0	004	BG Y Address
	RX—	0	0-2, 4-6	0	005	BG X Address
	EY—	0	0-2, 4-6	0	000	BG Y Address
	EX—	0	0-2, 4-6	0	001	BG X Address
	CY—	0	0-2, 4-6	0	006	BG Y Address
	CX—	0	0-2, 4-6	0	007	BG X Address
	RYB—	0	0-2, 4-6	0	010	BG Y Address
	RXB—	0	0-2, 4-6	0	011	BG X Address
	EYB—	0	0-2, 4-6	0	002	BG Y Address
	EXB—	0	0-2, 4-6	0	003	BG X Address
	RP—	0	0-2, 4-6	0	012	170
	RPC—	0	0-2, 4-6	0	012	171
	Read a Flip-flop	RFA—	0	0-2, 4-6	1	016
RFF—		0	0-2, 4-6	1	012	FF Number
RTB—		0	0-2, 4-6	1	012	174
Read the Scanner	RS—	0	0-2, 4-6	1	013	—
Read the Scanner and the BGS	RSY—	0	0-2, 4-6	0	020	BG Y Address
	RSX—	0	0-2, 4-6	0	021	BG X Address
	RSL—	0	0-2, 4-6	0	022	Next BG Address
Match	MY—	0	0-2, 4-6	1	034	FG Number
	MX—	0	0-2, 4-6	1	035	FG Number
	MB—	0	0-2, 4-6	1	036	FG Number
Non-Modifiable Decision	RYMFA—	1	3	0	BGY Address	FA Number
	RTW—	1	7	—	012	FG Number
	RTWS—	1	7	—	013	FG Number
	RYOS—	0	2	0	024	BG Y Address
	RYIS—	0	2	0	025	BG Y Address
	MXTMM—	1	7	0	004	FG Number

Table 9-1 continued on page 237

TABLE 9-1. ORDER CODING (continued)

Type of Order	Order Symbol	A	B	D7	Group I C	Group II D																																																																																																																																																																									
Transfer	T—	3	—	—	FSS X Address 005	FSS Y Address FG Number																																																																																																																																																																									
	TFG—	1	7	—			Write in the BGS	WOY—	1	7	0	000	BG Y Address	WY—	1	7	0	001	BG Y Address	WOX—	1	7	1	000	BG X Address	WIX—	1	7	1	001	BG X Address	WOP	1	7	0	006	170	WIP	1	7	1	006	170	WOPC	1	7	0	006	171	WIPC	1	7	1	006	171	RGY—	1	7	0	002	BG Y Address	RGX—	1	7	1	002	BG X Address	CYMP—	1	7	0	003	BG Y Address	Write in a Flip-flop	WOFA—	1	7	0	006	FA Number	WIFA—	1	7	1	006	FA Number	WOFF—	1	7	0	006	FF Number	WIFF—	1	7	1	006	FF Number	WISK	1	7	1	006	174	WOTB	1	7	0	006	174	SMTM	1	7	0	006	175	Access Register Operations	RYFA—	1	0	0	BG Y Address	FA Number	RXFA—	1	0	1	BG X Address	FA Number	RYFAS—	1	7	1	004	BG Y Address	WFAY—	1	1	0	BG Y Address	FA Number	WFAX—	1	1	1	BG X Address	FA Number	RPFAY—	1	4	0	—	FA Number	RPFAX—	1	4	1	—	FA Number	WFAPY—	1	5	0	—	FA Number	WFAPX—	1	5	1	—	FA Number	Gate	G—	1	3
Write in the BGS	WOY—	1	7	0	000	BG Y Address																																																																																																																																																																									
	WY—	1	7	0	001	BG Y Address																																																																																																																																																																									
	WOX—	1	7	1	000	BG X Address																																																																																																																																																																									
	WIX—	1	7	1	001	BG X Address																																																																																																																																																																									
	WOP	1	7	0	006	170																																																																																																																																																																									
	WIP	1	7	1	006	170																																																																																																																																																																									
	WOPC	1	7	0	006	171																																																																																																																																																																									
	WIPC	1	7	1	006	171																																																																																																																																																																									
	RGY—	1	7	0	002	BG Y Address																																																																																																																																																																									
	RGX—	1	7	1	002	BG X Address																																																																																																																																																																									
CYMP—	1	7	0	003	BG Y Address																																																																																																																																																																										
Write in a Flip-flop	WOFA—	1	7	0	006	FA Number																																																																																																																																																																									
	WIFA—	1	7	1	006	FA Number																																																																																																																																																																									
	WOFF—	1	7	0	006	FF Number																																																																																																																																																																									
	WIFF—	1	7	1	006	FF Number																																																																																																																																																																									
	WISK	1	7	1	006	174																																																																																																																																																																									
	WOTB	1	7	0	006	174																																																																																																																																																																									
	SMTM	1	7	0	006	175																																																																																																																																																																									
Access Register Operations	RYFA—	1	0	0	BG Y Address	FA Number																																																																																																																																																																									
	RXFA—	1	0	1	BG X Address	FA Number																																																																																																																																																																									
	RYFAS—	1	7	1	004	BG Y Address																																																																																																																																																																									
	WFAY—	1	1	0	BG Y Address	FA Number																																																																																																																																																																									
	WFAX—	1	1	1	BG X Address	FA Number																																																																																																																																																																									
	RPFAY—	1	4	0	—	FA Number																																																																																																																																																																									
	RPFAX—	1	4	1	—	FA Number																																																																																																																																																																									
	WFAPY—	1	5	0	—	FA Number																																																																																																																																																																									
WFAPX—	1	5	1	—	FA Number																																																																																																																																																																										
Gate	G—	1	3	1	FG Number (To)	FG Number (From)																																																																																																																																																																									

Table 9-1 continued on page 238

TABLE 9-1 ORDER CODING (continued)

Type of Order	Order Symbol	A	B	D7	Group I C	Group II D
Set-up	ST1—	4	—	—	T1 X Address	T1 Y Address
	ST2—	5	—	—	T2 X Address	T2 Y Address
	SA0—	6	—	—	A0 X Address	A0 Y Address
	SA1—	7	—	—	A1 X Address	A1 Y Address
	SY—	1	6	0	—	BG Y Address
	SX—	1	6	1	—	BG X Address
Repeat	RPT5—	1	7	0	007	Number of Exec.
	RPTD	1	7	1	007	Number of Exec.
Miscellaneous	ENS	1	7	1	006	177
	STD	1	7	1	006	176
	GBN	1	7	0	006	176
	AYBG	1	7	0	006	172
	AXBG	1	7	1	006	172
	HBG—	1	2	0	Hamming FF No.	BG Y Address
	HFA—	1	2	1	Hamming FF No.	FA Number
	HR	1	7	0	006	173
	RPW—	1	7	—	010	FG Number
	RPWS—	1	7	—	011	FG Number
	EXCH—	1	7	—	014	FG Number
GAIOS—	1	7	1	006	173	

End of Table 9-1

TABLE 9-2. PACKAGES USED IN EACH FSS

F-Spec. Number	CPS* No.	Quantity	Name
F-52703	8	14	AND Gate
F-52704	28	8	OR Gate
F-52706	27	8	Buffer Gate
F-52702	37	26	Flip-Flop
F-52978	87	1	Marginal Voltage Rectifier
F-52707	157	16	Switching Servo Logic
F-52713	161	9	Blocking Oscillator
F-52709	162	1	Gate Generator B
F-52718	163	1	Gate Generator A
F-52972	164	2	Analog Servo Logic
F-52711	166	3	Timer
F-52974	169	1	Transfer Timer
F-52976	174	3	Gate Generator C
F-52975	175	1	Gate Generator D
F-52973	176	1	Transfer Monitor
F-52715	178	11	Input Buffer
F-52716	179	3	Pulse Monitor
F-52960	241	68	Information Sampler
F-52961	242	18	Position Monitor Amplifier
F-52962	243	1	Activity Monitor Amplifier
F-52964	245	87	PMT Voltage Divider
F-52965	246	87	PMT Stabilizer
F-52966	247	2	Stabilizer Pulse Generator
F-52971	248	1	Intensity Monitor Amplifier

*CPS means Circuit Package Schematic.

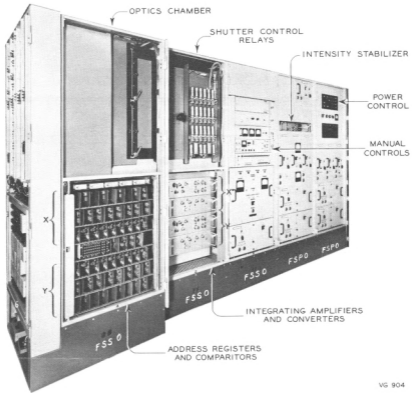
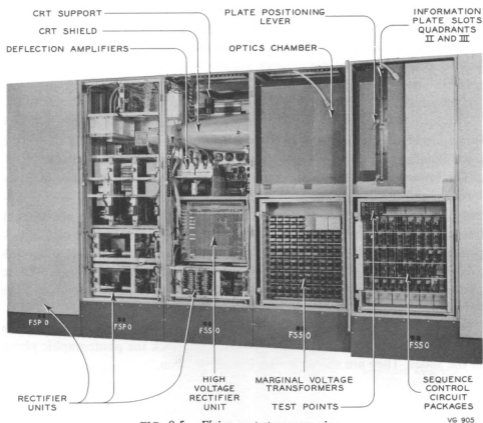

FIG. 9-4. *Flying spot store, front view.*

VG 904

here. A plastic door covers the lower half of this bay; it protects the packages and causes the cooling air to flow up past the packages even when the metal door is open. Test points in the register are brought out to the jacks in the fourth row of packages. Voltages required by the circuits in the end cabinet (bays 4, 5, and 6) are distributed through five plugs mounted above the packages. When you remove these jumper plugs, you disconnect these voltages from the end cabinet only.

FIG. 9-5. *Flying spot store, rear view.*

VG 905

9.3.2 Cabinet FSS-0, Rear Bays (Fig. 9-5)

Here you can see the rear of the rectifier units in the power cabinets. The CRT assembly extends from the right side of FSS-0, bay 1, into power cabinet FSP-0, bay 3. This CRT assembly is supported at its center of gravity by a spring-loaded device on a track. This support allows the tube to be pivoted and moved out of the cabinet when making a replacement. It also allows the tube to be moved by the wobblator. The wobblator causes continuous tube

movement to reduce phosphor wear, and thus to extend tube life. The tube is securely mounted in its shield, and the shield is clamped to the wobulator assembly at the faceplate end of the tube. Immediately below the CRT are the deflection amplifiers and the blowers.

In the lower half of FSS-0, bay 1, is the high-voltage supply for the CRT, and an additional rectifier unit.

The lower half of FSS-0, bay 3, contains marginal voltage checking transformers. These are mounted on a gate to permit access to the wiring side of the front chassis mounting plate and the terminal side of the transformers.

The lower half of FSS-0, bay 5, contains the packages, the filament transformers, and the equipment used in the sequence control circuits. This equipment is gate-mounted, and the gate has a plastic door. Test points are brought out to the jacks in the upper left corner of the gate. Just to the left of this jack panel is an emergency stop button. Similar red buttons are placed in other FSS cabinets to permit you to shut down the FSS during an emergency. These buttons open the major interlock circuit that removes primary power from the FSP control circuit.

The top halves of FSS-0, bays 3 and 5, contain the optic chamber. At the left of the plate slots are levers that position and lock the photographic plates in the slides. They are shown in the locked position.

9.3.3 *Cabinet FSS-0, Bay 6 (Fig. 9-6)*

In the upper half of bay 6 are the photomultiplier channels. Figure 9-6 is a view of a partially equipped cabinet. The position monitor channels are fully equipped and form a cross in the center of the bay. Altogether, 87 photomultipliers are needed to equip each FSS.

In the lower right corner is a meter used to adjust the position monitor level. Just to the left and below the meter is the selector switch that connects the meter to one of the position monitors. The selector switch can be operated electrically by the push button adjacent to the switch position indicator, or it can be operated manually. The switch on the right selects vertical position monitors; The switch on the left selects horizontal position monitors. A remote meter and two selector push buttons are mounted on the control panel in bay 0.

Controls and test points are brought out to a panel on each information sampler and each position monitor plug-in package. The packages are plugged into the connectors at the ends of the package guides. Through these connections all power and all input and output signals enter and leave the packages.

Common signal test points are brought out to the jack panel in the lower left corner. On the gate in the lower half of the bay are filament and marginal voltage checking transformers, and associated fuses.

An emergency stop button is located in the left center of the cabinet.

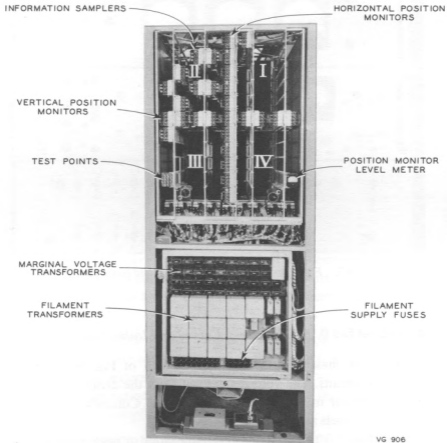

FIG. 9-6. *Flying spot store, end view.*

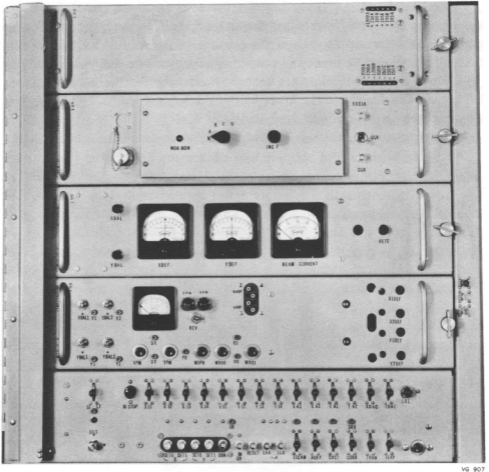

FIG. 9-7. Flying spot store manual control and meter panels.

VG 907

9.3.4 Cabinet FSS-0, Bay 0; Manual Control and Meter Panel (Fig. 9-7)

The first chassis (VTG MON) at the top of Fig. 9-7 contains the voltage monitor circuits. The voltages derived from the dividers in this circuit are sent to a monitor in the administration center. Controls at the right are used to adjust the levels sent to the monitor.

The second chassis (CLK) contains a variable clock or pulse generator, and a wobblator monitor. The clock output is used internally to address the FSS

during a scan mode of operation. The wobulator monitor detects a failure in the wobulator mechanism. Should the mechanism fail, a teletypewriter message notifies you of the failure.

The third chassis (MTR-B) contains controls and meters associated with the deflection systems. It also has the meter which indicates the CRT beam current.

The fourth chassis (MTR-A) contains a remote control and a meter circuit associated with the position monitors. The remaining controls on this chassis and on the fifth (bottom) panel are used for special tests. These are described in the circuit description, CD-1A005-01.

At the left of bay 0 is a hinged shield that covers the chassis fasteners. An interlock switch is opened when the shield is opened. This causes the control relays to release and to remove the d-c potentials from the FSS.

In the lower right corner of the bottom panel is an emergency stop button.

9.4 APPARATUS ELEMENTS

9.4.1 *The Optics System*

Precautions

In any work involving the optics system, the precautions listed below should be observed at all times.

- (1) If tests and observations indicate a need to open the optics chamber, a BTL representative should be notified. He will arrange for making any adjustments needed.
- (2) The position of each lens and code plate has been adjusted to a point of optimum operation. They are locked and cemented in this position. Under no conditions should field adjustments of these elements be attempted. The lenses should require no cleaning during the life of the FSS.
- (3) The optics elements are housed in a light-tight chamber. Its interior metal parts are coated with a dull-finish black paint to reduce reflections. Any external light entering the chamber can seriously impair the FSS operation. In sufficient quantities, in fact, such light can ruin the photomultiplier tubes (PMT's).
- (4) When cleaning the photographic plate tracks, be extremely careful to follow the procedure outlined in Specification X-63954. These

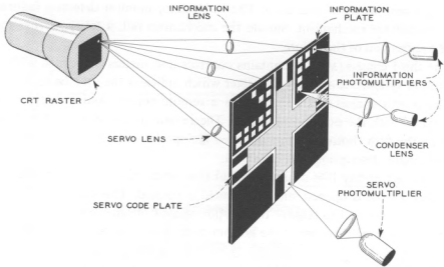
FIG. 9-8. *Flying spot store multiple information channels.*

VG 908

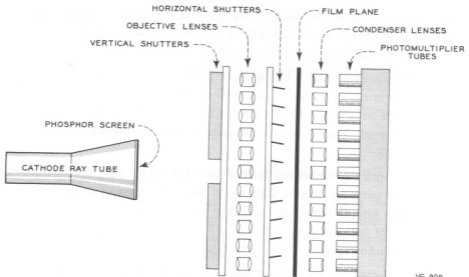
FIG. 9-9. *Flying spot store optics system elements.*

VG 909

tracks, in two of the quadrants, are adjacent to the vertical code plates. If any of these plates are moved, even slightly, the FSS will fail to operate.

The Elements of the Optical Channels

The elements of the optical channels are shown in Fig. 9-8. All the channels have a common light source: the spot on the CRT phosphor screen. Each objective lens produces an inverted reduced image of the CRT face on a photographic plate. Behind each image is a condensing lens and a photomultiplier tube (PMT).

There are ten vertical and ten horizontal shutters in the channels, as shown in Fig. 9-9. The vertical shutters are placed between the CRT and the objective lenses. The horizontal shutters are placed between the objective lenses and the photographic plates. The vertical shutters and the CRT are shown in Fig. 9-10. The shutters are used to select a channel during the exposure of a plate. When exposing a plate, the shutters are closed in all the channels except the selected

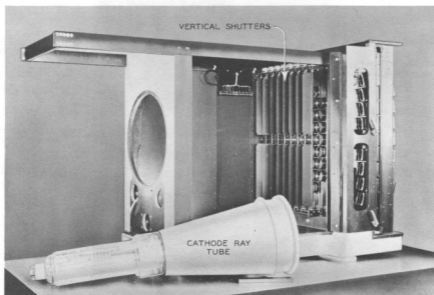

FIG. 9-10. *Flying spot store CRT and vertical shutter assembly.*

VG 910

channel. At all other times, all the shutters are open. Notice that there are no shutters in the beam-positioning channels.

Program and translation information is stored on four 10-by-12.5-inch glass photographic plates. There are seventeen storage areas on each plate, as shown on Fig. 9-11 (and more clearly indicated on Fig. 9-13). Each storage area is about 1.4 inches square. The code plates are about 2 inches square; they are mounted individually in the form of a cross on the center axes of the film plane. The arrangement is shown in Fig. 9-11 and Fig. 9-12. Fig. 9-11 also shows some of the condensing lenses.

Figure 9-12 shows the horizontal shutter and code plate assembly, with light passing through an objective lens. This figure indicates how a channel is selected by opening vertical and horizontal shutters.

When the light falls on a clear spot in the photographic plate, it passes through to the condensing lens and the PMT. The condensing lens focuses, on the face of the PMT, a spot of light of $\frac{3}{8}$ inch diameter. This spot remains fixed

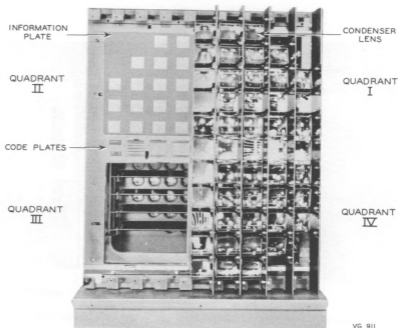

FIG. 9-11. Flying spot store lens and plate assembly.

Here
7-8-60

on the PMT for any position of the spot on the CRT screen. Holding the spot in a fixed position offsets any variations in the sensitivity at different points on the PMT photocathode.

The photomultiplier assignments are shown in Fig. 9-13. Each position is identified by a letter and a number. For example, the position designated A20 is the third bit of the A code in the order word; it is in the "zero" or even group of channels. The position designated E21 is the third bit of the error-correction information, in the "one" or odd group of channels. In the translation area, quadrant IV, position T8 is the ninth bit in each half of a translation word.

It is extremely important that the electron beam *must not be permitted* to remain on any spot in the phosphor for an extended period of time. The intensity of the electron bombardment will shorten the life of the phosphor coating or cause a burnt spot. Timers in the sequence control cause the beam to move off of the information storage area if no change in spot position occurs for about one millisecond.

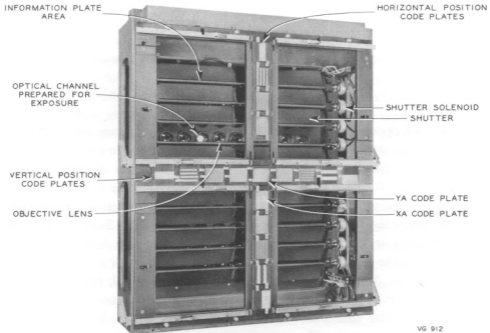

FIG. 9-12. Horizontal shutter and code plate assembly.

			D00	D50	X6	E01	E00			
		C00	D01	D51	X4	D70	E20	E40		
II	9	A20	C01	C40	D40	X2	D71	E21	E41	GR
	8	A21	B20	C41	D41	X0	D60	E10	E30	P0
	7	A10	B21	C30	D30	1M	D61	E11	E31	P1
	6	Y6	Y4	Y2	Y0	YA	Y1	Y3	Y5	Y7
	5	A11	B10	C31	D31	XA	T4	T9	T13	T15
	4	A00	B11	C20	D20	X1	T3	T8	T12	T14
III	3	A01	B00	C21	D21	X3	T2	T7	T11	TP
	2	SPT	B01	C10	D10	X5	T1	T6	T10	LM
	1	SPG0	XPMS	C11	D11	X7	T0	T5	YPMS	SPG1
		A	B	C	D	E	F	G	H	J

FIG. 9-13. Flying spot store photomultiplier assignments. ^{VG 913}

In normal operation, some sections of the stored program are used more frequently than others. This extra use causes the phosphor to age more rapidly in those areas than in other areas, and results in a corresponding reduction in light intensity. To offset this effect, and to increase the life span of the CRT tube, its mounting is driven by a system of cams that keep it constantly in motion. Since the locations of the information spots are fixed by the code plates, reading and writing are not affected. The movement is in a plane perpendicular to the optical axis. The primary movement is a spiral with a period of 1.3 minutes. A second cam displaces the primary spiral; this second cam requires 63.4 minutes to complete its cycle. The two movements combined produce a circular area with a diameter of about 0.3 inch, the equivalent of approximately 16 spots. The use of any single address is distributed over this area.

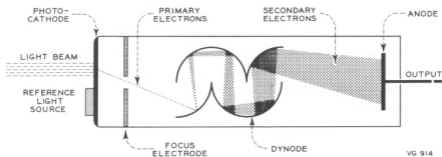

FIG. 9-14. Photomultiplier tube, schematic diagram.

9.4.2 The Photomultiplier Tube

The photomultiplier tube (PMT) is an electron tube with a photo-sensitive cathode that emits electrons when exposed to light. A simplified schematic diagram of the PMT is shown in Fig. 9-14. The electrons emitted by the cathode on the inner surface of the tube face are directed toward a series of ten dynodes. The primary electrons from the cathode strike the first dynode in the series, and release secondary electrons from it. The dynodes are formed and mounted to focus the secondaries successively on the next dynode in the string, and to block or deflect spurious electrons. As the electrons propagate down the string, at each dynode they release more electrons than arrive. The electrons released from the final dynode are collected by the anode. They are greater in number than the initial primaries released from the cathode. This increase results in a large current gain. The output signal, developed in the anode load, is further amplified in associated sampler circuits.

The flow of electrons down the dynode string can be regulated by adjusting the potentials applied to the dynodes. This characteristic is used to regulate the gain of the tube and to compensate for aging. A gain control, connected to dynodes 5 and 6, is used to vary the potential difference between these two dynodes. A potential difference of about 150 volts exists between the remaining dynodes in the string.

A standard light reference source is attached, off center, to the face of the PMT. The light emitted from this cell is used as a reference to adjust the gain of the PMT.

9.5 METHOD OF OPERATION

The interconnections between the flying spot stores (FSS's) and the central controls (CC's) are shown in Fig. 9-15. Operating orders are sent from the CC through the stand-by transfer to either FSS-0 or FSS-1. The active FSS is determined by the system; it can also be selected manually through the administration center.

9.5.1 Major Functional Units of the FSS (Fig. 9-16)

The major functional units of the FSS are shown in Fig. 9-16. The orders from the CC enter the sequence control circuit. This circuit controls the internal operations of the FSS. Also, it sends to the CC such control information as "good read" (GR), "transfer complete" (TRC), and "fixed transfer complete" (FTRC).

The addresses enter the address registers. Each register drives its servo, its digital-to-analog converter (DAC), its integrating and adder amplifiers, and its deflection amplifiers, to position the CRT electron beam.

The CRT generates a spot of light that is seen through the lenses and photographic plates by the PMT's in the information samplers. They feed program and translation information to the CC. They also send control information to

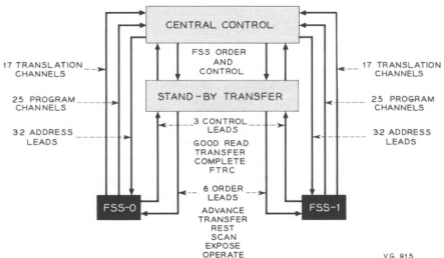

FIG. 9-15. Flying spot store and central control interconnections.

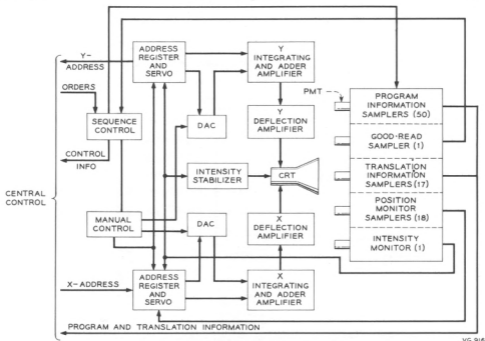

FIG. 9-16. *Flying spot store block diagram.*

the beam-positioning circuits and the sequence control. The number of samplers required for each type of information is shown in Fig. 9-16.

Manual controls provide a means for operating the FSS during routine tests or trouble maintenance.

9.5.2. Address and Beam-Positioning Circuits (Fig. 9-17)

The address and beam-positioning circuits convert the binary address from the CC to a deflection voltage to position the CRT beam. Each address specifies a spot on the photographic plates at which information is stored. These spots are arranged in a checkerboard pattern, thus providing more space between the dots than would be possible if they were in a sequential order. The use of two groups of program information channels makes up for the spots lost in the checkerboard pattern. The X0 address bit is used to select one of the two information groups. This arrangement provides a total of 65,536 storage spots on the photographic plates.

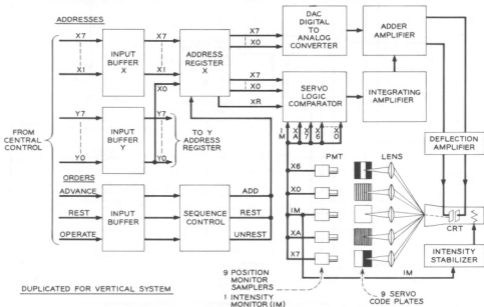

FIG. 9-17. Flying spot store horizontal address and position circuits.

The addresses and orders that affect the beam position enter the address register and sequence control through the input buffers. The register remembers the address while the beam-deflection circuits position the beam to it.

The address register drives a high-speed, coarse-positioning, digital-to-analog converter. It also drives a slow-speed, fine-positioning circuit. The slow-speed circuit uses a servo system with a beam encoder. Nine servo code plates in each axis, with their associated position monitors, are the heart of the beam encoder. The position monitors see the light beams through the code plates when the beam is on the information storage area of the CRT. If the beam is off of this area, they see no light. Since the code plates are alternate clear and opaque bars, the position monitors will see light only when the beam is positioned to pass through a clear area. The code plate bars have a binary-type configuration. This causes the position monitor outputs also to be of the same binary type. This information is fed to the comparator (servo logic).

The servo code plates in the center of the film plate plane are shown in Fig. 9-18. This is an enlarged view of a portion of the plates. Here you see the vertical (Y) and the horizontal (X) positioning plates. The intensity monitor

(1M) channel is included. Beams are shown positioned at two addresses, (A) and (B). The addresses generated by the light beams falling in these areas are also shown. You will note that when the light beam settles on an address, it is bisected by an edge of an opaque bar on the XA and YA code plates. The XA and YA position monitors (Fig. 9-17) feed this half-light output signal to the comparator. The remaining position monitors see either full light or no light, and they supply their companion circuits in the comparator with this information. The comparator takes the beam location address, as seen through the code plates, and compares it with the desired address from the register. The result of the comparison is a drive signal to the integrating amplifier. If the

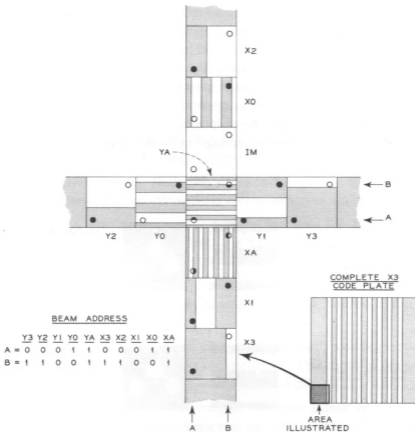

FIG. 9-18. Flying spot store servo code plates.

beam is to the right of the address specified in the register, it is deflected to the left. If it is to the left of the address, it is deflected to the right.

When the beam position address is identical to the register address, the beam movement is stopped. It remains locked to this address until the address in the register is changed. A new address from the CC, an advance or rest order from the CC, or a time-out signal from the sequence control, will change the register address.

The integrating amplifier compensates for various limitations in the elements of the servo loop and deflection system. Its output is combined with the DAC output in the adder amplifier. The balanced output of the adder amplifier is changed to a deflection voltage in the deflection amplifier to position the CRT beam.

The intensity monitor, IM, is mounted near the center of the optical channels with the position monitors. It detects variations in light intensity, and supplies a reference voltage to the comparator and intensity stabilizers (see Fig. 9-17).

Light beams in ideal positions are shown in (a) of Fig. 9-19. Here you see a beam bisected by the edge of a dark bar on the YA code plate, and another beam centered on a spot on the information plate. If the beam settles on an area of aged phosphor, it may be mispositioned as shown in (b) of Fig. 9-19. The intensity monitor reference voltage instantly causes the comparator to

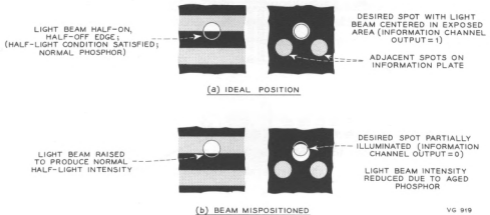

FIG. 9-19. The effect of low light intensity on beam positioning.

correct for this mispositioned beam effect, and the beams finally settle as shown in (a) of Fig. 9-19.

The intensity stabilizers (see Fig. 9-17) also feed a reference voltage from the IM. The stabilizer varies the electron beam intensity by changing the grid bias potential of the CRT. In doing this, it varies the intensity of the light emitted by the phosphor. When a change in light level occurs, the reference voltage shifts. This shift is sensed by the stabilizer, which alters the grid bias to return the light intensity to a specified level. The stabilizer response to a change in light is fast enough to hold the level constant for the information samplers.

9.5.3 The Sequence Control

An active FSS has two fundamental operating modes: *advance* and *transfer*. The sequence control circuits direct internal operations of the FSS in these modes on orders from the CC.

A stand-by FSS can be in one of three operating modes: *rest*, *scan*, or *expose*. The sequence control in the stand-by FSS directs its action in these modes on orders from the CC.

CC Orders That Initiate Modes

The orders that initiate the modes in the FSS's are these:

- (1) *Advance* (ADV). The CC sends this order to the active FSS when it wants the next order in a series. No address accompanies this order.
- (2) *Transfer* (TR). This order, with an address, transfers the FSS beam to the first word of a new series of orders. The CC operations cease until the first word is in its order word register (OWR).
- (3) *Rest* (RST). This order deflects the CRT beam behind a shield, off of the phosphor. The address register is sent to the rest address through the operation of the sequence control.
- (4) *Scan* (SC). A stand-by FSS, when given this order, will scan sequentially all the addresses under control of its internal clock. This mode of operation is used to ease the phosphor aging, and to exercise the FSS.
- (5) *Operate* (OPR). A stand-by FSS may be in either a *scan* or a *rest* mode, and it must be alerted before it is given an order to read. This order takes the address register out of rest, and provides an initial drive to the deflection

- system. In doing this, the beam is deflected to the storage area of the phosphor so that the position monitors can determine the beam location.
- (6) *Expose (EXP)*. This order is sent to a stand-by FSS which is preparing photographic plates from the exposure address and plate verification unit. The address of the spot, and the channel designation, accompany the order. This order is also used when verifying the exposed plate information.

Control Signals Returned to the CC

Three control signals are returned to the CC from the FSS sequence control. They are:

- (1) "Good Read" (GR). This signal is derived from an information sampler with an information plate containing all 1's. The spots on this plate have diameters that are somewhat smaller than the diameters of the spots on the program and translation plates. If a 0 is read in the "good read" channel, it is assumed that errors exist in other channels as well. The CC acts to remove the word in its OWR, and it blocks any action other than sending an *advance* order to the FSS. Since the FSS internal advance is blocked on a "bad read", its address registers cannot change, and the beam remains at the address of the "bad read" word. Upon receiving the *advance* order from the CC, the FSS rereads the word. Repeated "bad reads" at the same address cause the FSS to time-out (1 millisecond), and to deflect its beam to the rest position. The CC continues to send *advance* orders to the FSS, but fails to receive program orders from the FSS. The CC continues this action for 100 milliseconds, after which an emergency alarm switch occurs. This switch makes active the stand-by FSS, CC, and SD.
- (2) "Transfer Complete" (TRC). This control signal notifies the CC that a transfer has been completed and that the word at this specified location is in the OWR of the CC. The time between receipt of the *transfer* order and transmission of the TRC signal depends on the time required to settle the FSS beam on the new address.
- (3) "Fixed Transfer Complete" (FTRC). During certain tests and maintenance routines, it is necessary to read a word in the stand-by FSS. This action is started by the active units. Because the system has no record of the beam location in the stand-by FSS, a maximum time (12.5 microseconds) is allowed for the words from the stand-by FSS to enter the OWR in the CC. The timing is done in the active FSS; the word is read from the stand-by FSS.

Additional Functions of the Sequence Control

Some additional functions of the sequence control are:

- (1) The X0 address bit is used to determine which group of information samplers will sample the information at a specified address.
- (2) A *transfer* order or an *advance* order generates a pulse that samples the information in the information samplers. The output is sent to the CC.
- (3) Timers in the sequence control circuit control the length of time that the beam is permitted to remain on any address. If the beam remains on an address for more than one millisecond, time-out occurs and the beam is deflected to the rest position. This is done to extend the life of the phosphor.
- (4) The sequence control circuits produce a rest-address signal from an internal time-out or an order from the CC.
- (5) A "good read" signal is produced by combining the output of the GR information sampler with a delayed order pulse. The resultant is sent to the CC.
- (6) When the FSS is in the *advance* mode of operation, a GR will produce an ADD signal to the address register. This results in the beam being deflected to the next sequential address.
- (7) Signals from the beam-positioning circuits are combined with the *transfer* order. This produces a "transfer complete" signal when the positioning circuits indicate that the beam is locked on the address.
- (8) The sequence control circuit controls the address register advances on *transfer* orders. After the first word is in the CC, the beam is deflected to the next serial address without any additional orders from the CC. The word at this address is read into the CC buffer register, and the beam is deflected to the next address. It remains at this new address awaiting further orders from the CC.
- (9) Pulses from the clock in the stand-by FSS, bay 0, are combined with the *scan* order to cause sequential addressing of the stand-by FSS. When this occurs, the address registers are set to zero. Then they are advanced serially to the address with the highest number. The registers are then sent to the rest address for 12 milliseconds, after which the above operation is repeated. This *scan* mode may be started through manual controls.

9.6 POWER

The d-c power for each FSS is supplied by thirteen plug-in rectifier units in its associated power cabinets, FSP-0 (see Fig. 9-20). The a-c power for the units is fed from the regulated 230-volt a-c buses as follows:

Bus A: FSP-0 }
 Bus B: FSP-1 } See Fig. 1-18

A 48-volt source is required for control circuits in cabinets FSS-0 and FSP-0. It is supplied from the central office battery as follows:

Bus A: FSP-0 and FSS-0 }
 Bus B: FSP-1 and FSS-1 } See Fig. 1-19

9.6.1 Power Controls

These circuits, in the top of FSP-0, bay 0, control the application of a-c and d-c power to the FSS. Relays are used to turn on power in a sequence that slowly brings the tube filaments up to operating temperature. The a-c power is applied to the rectifiers in three groups to reduce load effects on the a-c buses. Power is removed from the equipment in steps for the same reason.

Red and white indicator lamps show the state of the power control circuit and the power alarms. The white lamps indicate closed interlocks, the presence of input voltages, and the steps in the switching sequence. The red lamps indicate open interlocks, the absence of input voltages, and rectifier and filament alarms.

To start a turn-on sequence, the circuit breaker is closed and the start button is operated. It takes eighty seconds for the filaments to be brought up to operating voltage. After an additional time delay of forty seconds, the first group of rectifiers have 230 volts a-c switched to their inputs. The remaining two groups of rectifiers are switched on at two-second intervals. The application of the d-c power to the FSS can be delayed through the operation of the d-c output switch. When this switch is in the test position, the d-c power is not applied to the FSS. A ten-second time delay occurs after the switch is operated to the normal position before d-c power is applied to the FSS.

Each rectifier has a high-low voltage alarm which gives a signal to the power control circuit when the voltage is out of limits. These limits are +10% or -25% of rated value. A rectifier alarm causes the d-c potentials to be removed from the FSS.

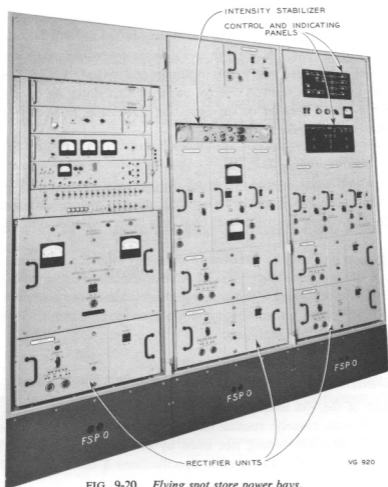

FIG. 9-20. *Flying spot store power bays.*

There are two interlock circuits in the FSS. Opening the minor interlock circuit removes the rectifier d-c output voltages from the FSS. Opening the major interlock circuit removes both the a-c filament voltage and the d-c voltages from the FSS. In either case, the shut-down occurs in a series of steps to eliminate surges on the power buses. The major interlock switches are located on the back doors of the power cabinets, FSS, bay 1, and on the gates in bays 3, 5, and 6. The minor interlock switches are located on the plastic doors in

bays 4, 5, and 6, on the deflection amplifier blowers, and on the hinged shields in bays 0 and 2.

When you shut down an FSS, always operate the stop button on the FSP control panel, or the emergency stop button in one of the FSS bays. Never open the circuit breaker on the FSS control panel to shut down an operating FSS. Opening the circuit breaker on an operating FSS causes line surges that will affect other ESS equipment.

9.6.2 Rectifier Units (Fig. 9-20)

These units supply regulated d-c voltages between 7.5 volts and 10,000 volts to the FSS. There are alarm circuits, test points, and controls on each unit. The circuit description of each unit covers its operation and maintenance.

Each plug-in unit may be removed from its bay after the fasteners and connections in the rear have been released. Always disconnect input voltages from the FSP before working on a rectifier unit. Always check the unit to be certain that no voltage exists before starting to work on it. This can be done with a voltmeter at the front of each unit.

9.7 MAINTENANCE

Most of the FSS testing is done by the system. It makes four types of programmed tests, namely: routine tests, diagnostic tests, marginal tests, and demand tests. The FSS testing not done by the system, together with other maintenance procedures, is covered in Specifications X-63954 and X-63941.

9.7.1 Routine Tests

Routine tests are used to detect the presence of trouble in either the active or the stand-by FSS, and to request a diagnosis. These tests are performed at various intervals, such as 100 milliseconds, one second, one-half hour, or one hour. The following list contains a brief description of each routine test and gives the frequency with which it is repeated:

- (1) A check of the read-out from the active FSS by means of program test words is made every 100 milliseconds.
- (2) A check of the "bad read" counter for the active FSS is made every 100 milliseconds.

- (3) A test that matches program words in the active FSS with those in the stand-by FSS at various addresses is repeated every second.
- (4) A check of the read-out from the stand-by FSS by means of program test words is made every second.
- (5) A check of the read-out from the active or stand-by FSS by using translation test words is repeated every second.
- (6) A check of the ability of the stand-by FSS to rest, scan, advance, and transfer is made every second.
- (7) A check of the wobulator points in the active and stand-by FSS's is made every half-hour.
- (8) A check of the active and stand-by voltage supplies is made every half-hour.
- (9) A check of the stand-by servo is repeated every hour.
- (10) A check for dust on the photographic plates in the active and stand-by FSS's is made every hour.

9.7.2 Diagnostic Tests

The diagnostic tests make a thorough check of the various functional units in the stand-by FSS. These tests, which are performed whenever needed, consist of readings taken at:

- (1) scan points associated with strategic points within the circuits;
- (2) voltage monitor points;
- (3) appropriate addresses on the plates; or
- (4) central control flip-flops.

Special circuit conditions, when needed to administer any of these tests, are set up before taking a reading. Print-outs identify all the tests that fail. For each listed message, the dictionary will specify the faulty package or packages to be replaced. Also, it will give other instructions where needed.

9.7.3 Marginal Tests

Marginal tests, made every night, are preventive maintenance tests. In each test, a positive or negative 60-cycle sine-wave voltage is superimposed

on the voltage normally applied to a specified point in a circuit. The circuit is examined at 100-microsecond intervals to determine its response while the sine-wave voltage is applied. There are 136 marginal voltage tests made on each FSS every night. Each failure is recorded on a print-out that identifies the test and the point that failed.

9.7.4 *Demand Tests.*

Demand tests can be requested by the maintenance man through the teletypewriter. The maintenance dictionary gives the exact form of the input messages and the corresponding answers from the system. Only the specified information should be used, because arbitrary addresses may cause improper operation.

These tests may include a particular routine test or diagnosis at the beginning of a series or at an intermediate phase. A complete series of marginal voltage tests may also be started with these tests. A teletypewriter print-out gives the results of any demand test.

Chapter 10

The Central Control

The central control (CC) has been called the “brains” of the ESS. To qualify for this title, it would have to include the stores that provide the necessary memory elements. It would be more accurate, perhaps, to call the CC the “central nervous system” of the ESS. For, either directly or indirectly, the central control regulates the actions of all the components in the system. The CC senses changes in the traffic demands, and directs the system to handle these changes in a manner predetermined by the program in the flying spot store (FSS).

The central control (CC) is primarily a logic machine. It is continually interrogating the system, making decisions, and giving orders. The program writers have actually made the decisions beforehand, basing them on all possible conditions of the system. But from the system’s point of view, the central control is the boss.

Ordinarily, the system operates without human direction, even checking itself for errors, faults, and weaknesses. Only when faults are detected, or when changes in customer service occur, is outside help needed.

The CC coordinates and directs the handling of office traffic on a time-sharing basis. During the progress of a call, the calling customer, and *all the other customers* in the office, will have received some kind of attention from the system many times. But, because the CC operates at such tremendous speed, the customers are not aware of this. Each customer feels that he is getting undivided attention.

10.1 EQUIPMENT ARRANGEMENTS

The central control (CC) is one of the completely duplicated component sections of the ESS. The duplicate CC’s are designated CC-0 and CC-1; these

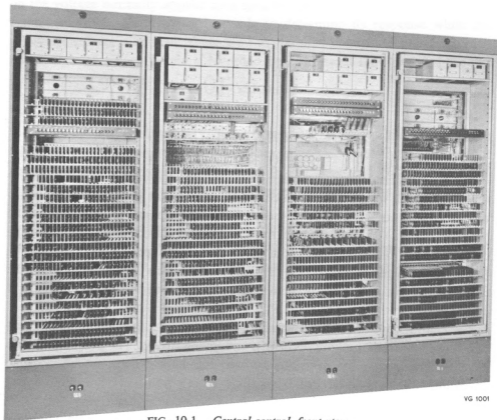

FIG. 10-1. Central control, front view.

designations are marked on the outside of the cabinets in which the equipment is installed.

Each CC is housed in four cabinets, as shown in Figs. 10-1 and 10-2. Each cabinet contains equipment mounted in two bays. One bay is hinged to permit access to the inside of the cabinet. The other is fixed. The bays are numbered from 0 through 7, and the number of each bay is marked on the cabinet designation plate and at the bottom of its frame within the cabinet. The even-numbered bays are hinged; the odd-numbered bays are fixed.

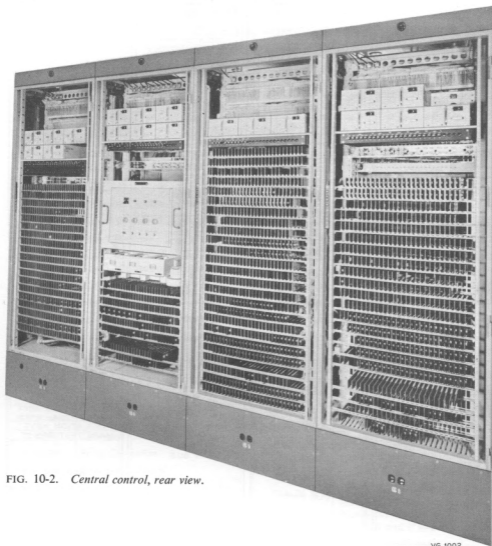

FIG. 10-2. Central control, rear view.

VG 1002

Except for the clock pulse power supply and the terminal strips, all the CC equipment consists of apparatus assembled on mounting plates.

Most of the apparatus in the CC consists of printed-wiring boards, commonly called "packages." Each mounting plate can hold twenty-eight of these packages. The packages are designated A through AF from left to right. All the packages in the CC are of the narrow type shown at (a) in Fig. 1-9 of Chapter 1.

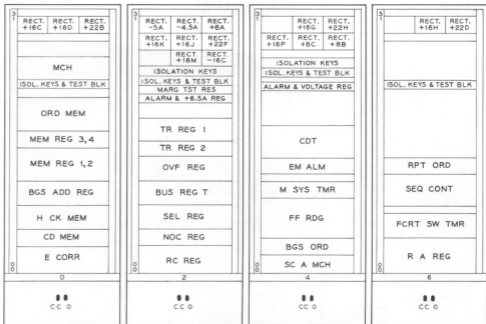

FIG. 10-3. Central control equipment, front.

VG 1003

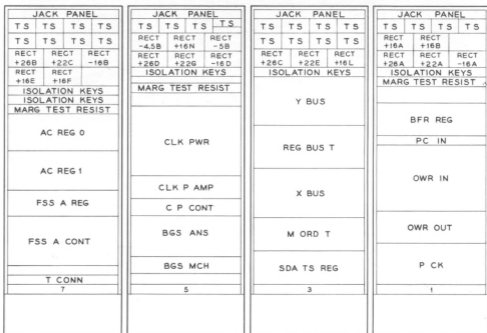

FIG. 10-4. Central control equipment, rear.

VG 1004

Figure 10-3 shows the layout of the central control equipment for the even-numbered bays; Fig. 10-4 shows the layout for the odd-numbered bays. Abbreviations for the equipment unit functional designations are marked on the right side of the bay frame opposite the equipment. Table 10-1 lists the titles of these abbreviations.

TABLE 10-1 ABBREVIATIONS FOR EQUIPMENT FUNCTIONAL DESIGNATIONS

Abbreviations	Equipment Functional Designations	Abbreviations	Equipment Functional Designations
AC REG 0	Access Register 0; also, Scanner Cable Driver	M ORD T	Miscellaneous Order Translator
AC REG 1	Access Register 1	M SYS TMR	Main System Timer
BFR REG	Buffer Register	MT	Manual Test and Step-by-Step FSS Advance
BGS ADD REG	BGS Address Register; also, Add-1 BGS Address Register	NOC REG	Network and Office Concentrator Control Register
BGS ANS	BGS Answer	ORD MEM	Order Memory
BGS MCH	BGS Match	OVF REG	Overflow Register
BGS ORD	BGS Order Routing	OWR IN	Order Word Register Input
BUS REG T	Bus to Register Translator	OWR OUT	Order Word Register Output
CC	Central Control	PC IN	Program Channels Input
CD MEM	CD Memory	P CK	Parity Checker
CD T	C Translator and D Translator	PROG CKG	Program Checking
CLK P AMP	Clock Pulse Amplifier	R A REG	Return Address Register
C OWR	Changed Order Word Register	RC REG	Remote Concentrator Register
E CORR	Error Correction	REG BUS T	Register to Bus Translator
EM ALM	Emergency Alarm	RPT ORD	Repeat Order
FCRT SW TMR	Fault-Checking Routine Transfer; also, Test Circuit and Switch Timer	SC A MCH	Scanner Answer and Match
FF RDG	Flip-Flop Reading	SDA TS REG	Signal Distributor Address Register and Enable Scanner; also, Distribution Network Trunk Selectors A and B Registers.
FSS A CONT	FSS Address Control	SEL REG	Line Selector Register and Concentrator
FSS A REG	FSS Address Register; also, Add-1	SEQ CONT	Sequence Control
G P CONT	Gating Pulse Control	T CONN	Test Connector
H CK MEM	Hamming Check Memory and Memory Flip-Flops	TR REG 1	Transfer Register 1; also Add-1
MCH	BGS MM Match	TR REG 2	Transfer Register 2
MEM REG 1, 2	Memory Registers 1 and 2	TR R REG	Transfer Record Register
MEM REG 3, 4	Memory Registers 3 and 4	X BUS	X Bus Access
		Y BUS	Y Bus Access

10.2 METHOD OF OPERATION

The central control has four major functions:

- (1) It translates program orders.
- (2) It uses the translated information to prepare itself to carry out the order.
- (3) It controls all other system units as directed by the program.
- (4) It makes decisions based on program orders and on answers from other system units.

The central control (CC) controls all the other system units on a time-sharing basis. It is primarily a logic circuit which translates the stored program orders on a one-at-a time basis. A program is a set of coded orders or instructions specifying exactly what the system must do at all times and under all possible customer input situations. The program orders are stored in the flying spot store (FSS).

An order can be divided into two parts: (1), what to do; and (2), where to do it (the address). Progress through the program, order by order, is controlled by a system clock whose cycle time is about 3 microseconds. When a program order is passed from the FSS to the CC on the occurrence of a clock pulse, the CC translates the order and prepares itself to carry out the order before the next clock pulse. The next clock pulse causes the execution of the order, and also causes the next order in the program to enter the CC; this sequence is shown in Fig. 10-5. The order-by-order progression just described is altered for decision orders, as will be discussed later.

There are two types of orders in the program: *nondecision orders* and *decision orders*. A nondecision order can lead only to one order in the program. A decision order can lead to one of two orders in the program.

An example of a nondecision order is: "Write a 0 in the BGS at the Y-address specified, X-address preset" (WOY). This order is straightforward and requires no answer from the BGS. The BGS writes a 0 at the address given.

An example of a decision order is: "Read and regenerate in the BGS at the Y-address specified, X-address preset, and transfer if you read a 0" (RYO). The decision comes about when the answer is returned to the CC from the BGS. If the answer is a 1, the CC directs the FSS to send the next order in the program. If the answer is a 0, the CC sends the FSS to the location of the address stored in the transfer register, as explained in detail later.

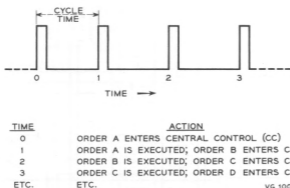

FIG. 10-5. ESS clock timing.

Besides the program order information stored in the FSS, there is stored translation information. This information includes translations pertaining to classes of service, directory numbers to equipment numbers, and trunk-base numbers.

The CC circuits shown on Fig. 10-6 can be divided into two general groups: (1), circuits functionally associated with other system units; and (2), internal control circuits and registers. Both groups of circuits are described in subsections 10.2.1 through 10.2.8, which follow.

10.2.1 Circuits Associated with the Flying Spot Store (Fig. 10-7)

Addresses for the location of a particular piece of information stored in the FSS are passed from the CC to the FSS. Program orders and translation information are passed from the FSS to the CC. This communication between the CC and the FSS is controlled by the circuits shown in Fig. 10-7.

When the system is first turned on, the FSS is directed to the location of the first order that the system wants. This starts system operation. The first order in the program is passed around the Buffer Register* (BFR) into the Order Word Register (OWR). The second order is put into the BFR before the first clock pulse. On the occurrence of the first clock pulse, the order in the OWR is executed, the order in the BFR is passed to the OWR, and the flip-flops in the BFR are reset. Between clock pulses, the order in the OWR is translated by the Order Word Translator (OWT). The OWT is made up of the following translators

*A "register" is a group of memory elements functionally related.

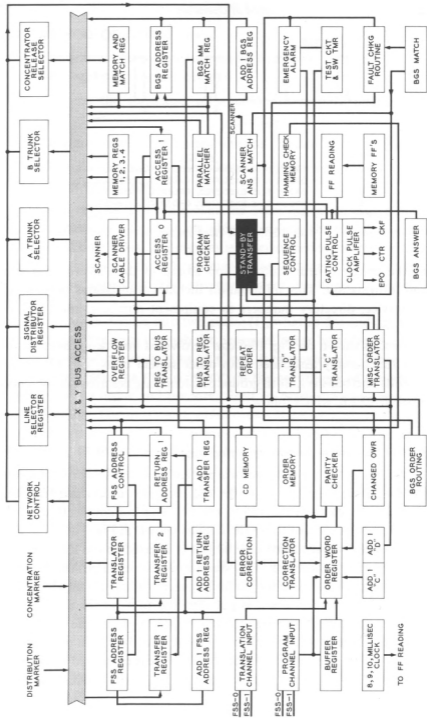

FIG. 10-6. Central control block diagram.

shown on Fig. 10-6; bus to register, register to bus, miscellaneous order, and the C and D translators. The OWT has about 300 output leads. These leads are the gating leads within the CC, and some of them are made active to carry out each order processed.

So far, this story is true for both decision and nondecision orders. And, as long as nondecision orders are processed by the CC, the procedure for executing them is as described above.

Now let's take decision orders. Transfers may be expected as a result of the decision orders, "read and match," and the nondecision order, "transfer." "Transfer," here, means a jump from the location of one program sequence in the FSS to the start of another sequence. When one of the decision orders is specified, the address or location of the new program sequence is stored in one of the Transfer Registers before the decision order is executed.

When a decision order transfer condition is met, the next clock pulse for the CC is called a Conditional Transfer Pulse (CTR). This pulse will be explained fully in the following section.

Now let's discuss, with the help of Figs. 10-7 and 10-8, the progress of a decision order through the CC, and the timing in the CC for a transfer. At time 0, Fig. 10-8, the decision order A enters the BFR. Since this is a decision order, the address for the new program sequence location is already stored in a transfer register. We'll call the first order in this new program sequence, "order P." At time 1, order A is passed to the OWR, and the BFR flip-flops are reset. Before the next clock pulse, order B enters the BFR. The OWR serves as an inspection and correction station, as well as a temporary storage area for program order and translation information from the FSS. Before the next clock pulse, order A is translated by the Order Word Translator, OWT. At time 2, order A is executed, order B enters the OWR, and the BFR is reset. Shortly after time 2, order C enters the BFR. The order memory retains the pertinent information about the decision until the next clock pulse. Before the next clock pulse, the answer for the transfer condition imposed by order A is returned to the CC. The transfer condition is met. The next clock pulse, at time 3, is called the Conditional Transfer Pulse, CTR. The transfer stops the clock and causes the following actions:

- (1) The address of order P is gated through the FSS address control to the FSS and at the same time to the FSS address register.
- (2) A transfer signal is sent to the FSS via the FSS control in the stand-by transfer.

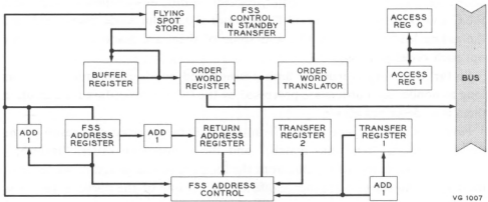

FIG. 10-7. Central control circuits associated with the flying spot store.

- (3) The address for order B, that was stored in the FSS address register, is gated to the return address register. This allows the system to go back to order B after the transfer, if it wants to do so.
- (4) The BFR and the OWR are cleared to accept the new orders, and order P will be put right into the OWR, and order Q into the BFR.
- (5) The order memory is reset.
- (6) The transfer is reported to the sequence control.

At time 3+, the CC receives a "transfer complete" (TRC) signal from the FSS. To the CC, the TRC means that the FSS has sent order P to the CC. Before the next clock pulse in the CC, which will execute order P, order Q is sent from the FSS to the BFR. One cycle time (3 microseconds) after the TRC, the CC generates its next gating pulse. Order P is executed.

One very important fact to remember is—*The FSS address register always contains the address of the order in the OWR.* This is how the system always knows where it is in the program.

On a direct transfer (a nondecision order to transfer), the timing in the CC is the same as previously explained for conditional transfers of decision orders, except that the transfer starts with the execution of the order. There is a difference in the circuit operation of the return address register. An EPO (execute present order) clock pulse executes all orders. On direct transfer orders, EPO activates the "add 1" circuit associated with the return address register. This

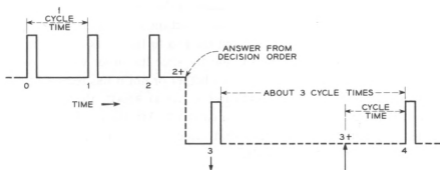

TIME	ACTION
0	ORDER A ENTERS BUFFER REGISTER (BFR)
1	ORDER A ENTERS OWR; ORDER B ENTERS BFR
2	ORDER A EXECUTED; ORDER B IN ORDER WORD REGISTER (OWR); ORDER C ENTERS BFR
3	STOPS CLOCK; STARTS TRANSFER TO ORDER P
3+	TRANSFER COMPLETE FROM FSS; ORDER P IN OWR; ORDER Q IN BFR; CLOCK STARTS
4	ORDER P EXECUTED; ORDER Q IN OWR

VG 100B

FIG. 10-8. ESS clock timing for transfers.

adds 1 to the Y part of the address coming from the FSS address register to the return address register.

Very often the system needs translation information to complete calls. The CC handles translation information somewhat differently from program orders. As you probably know from reading a previous chapter, sixteen channels of the FSS are reserved for translation information. All translation words are passed from the FSS via the translation channel inputs directly into the OWR. They are then gated over the BUS to an access register. Translation words require two readings by the FSS; so it passes two words of sixteen bits each to the CC. The first sixteen-bit word is stored in access register 0 and the second in access register 1. They are then used as required by the program.

Parity for translation words is checked for all thirty-two bits, by examining the first sixteen bits and then the next sixteen bits. This parity check* is *good* if the number of 1's in the word is *even*; it *fails* if the number of 1's is *odd*. If over-all parity is good, the address in the return address register is gated to the FSS, and the system goes back to the original program. If parity fails on the

*A parity check determines whether a given word contains an even number or an odd number of 1's.

over-all word, the address previously stored in the transfer register is gated to the FSS, and a special program is used to correct the translation word.

One other very important signal from the FSS to the CC is called the GOOD READ bit. This bit arrives in the CC shortly after the order word is received. It is in the OWR that the CC determines whether or not it has received a GOOD READ from the FSS. If the bit indicates a GOOD READ, the order word is processed. If the bit does not indicate a GOOD READ, the CC does not process the order, but tells the FSS to read that same spot again. The GOOD READ bit is ignored for translation words.

10.2.2 Decision-Making Circuits (Fig. 10-9)

When the order-by-order progression through the program is altered, the decision-making circuits start the change. The clock pulse is amplified in the CC and is passed to the gating pulse control circuit. This circuit, governed by input information from the other circuits on Fig. 10-9, determines the next kind of gating pulse for the CC. There are three kinds of gating pulse outputs from the gating pulse control. They are:

- (1) EPO (execute present order)—activates gating leads to execute the order in the OWR (order word register.) This is the pulse most often used in the CC.
- (2) CTR (conditional transfer)—activates gating leads to cause a transfer to a new program sequence in the FSS.

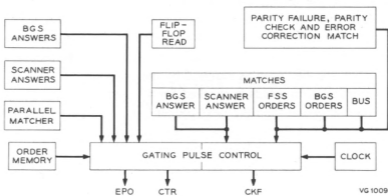

FIG. 10-9. Decision-making elements.

- (3) CKF (check failure)—activates gating leads to start the system in a fault-checking routine for locating trouble, or to start the error correction program. This is the pulse least often used in the CC.

The gating pulse control is made up of three groups of AND gates. The AND gate output leads are connected by group to one of three OR gates. One OR gate output lead, when active, transmits an EPO; another OR gate, the CTR; and the last OR gate, a CKF output pulse. Since only *one* AND gate will be active at any one time, the CC gets only one pulse.

The following circuits match the information of one CC against the same information in the other CC:

- (1) The BUS match circuit.
- (2) The BGS order match circuit.
- (3) The FSS order match circuit.
- (4) The parity check match circuit.
- (5) The error correction match circuit.

A mismatch in any one of these circuits causes a CKF in both the CC's and starts the fault-checking routine to find out which CC caused the trouble. A mismatch in either of the following two match circuits causes a CKF output pulse:

- (1) Scanner answers (one scanner against the other on test points only).
- (2) BGS answers (one BGS against its stand-by).

A mismatch in either of these circuits also causes a transfer to the fault-checking routine to determine which unit is at fault.

A parity failure in both the CC's (an odd number of 1's in the order word) makes the gating pulse control put out a CKF, but this CKF starts error-correction action by both the CC's.

There are five more circuits shown on Figure 10-9, namely:

- (1) The order memory circuit.
- (2) The BGS answer circuit.
- (3) The scanner answer circuit.
- (4) The parallel matcher circuit.
- (5) The flip-flop read circuit.

These circuits pass information to the gating pulse control which causes its output pulse to be either a CTR or an EPO. The order memory stores order information required to determine the next output pulse from the gating pulse control. For example, here is an order previously mentioned: RYO, "read the BGS at the Y address specified, and transfer if a 0." This order asks the BGS, "Is this particular memory spot a 0 or a 1?" It (the order) also tells the CC, "if the answer is a 0, transfer to a new program sequence in the FSS." So the order memory remembers for the CC: (1), that the question was asked of the BGS; (2), to transfer, if the answer from the BGS is a 0; and (3), what transfer register should be gated to the FSS.

If the answer from the BGS is a 1, the next output of the gating pulse control is an EPO. The EPO executes the order that is in the OWR. If the answer from the BGS is a 0, the gating pulse control sends a CTR through the CC.

The BGS answer circuit, the scanner answer circuit, the parallel matcher circuit, and the flip-flop read circuit, all help the gating pulse control to make its decisions. The BGS answers and scanner answers are answers received by the CC during the time between the execution of an order and the next clock pulse. The parallel matcher circuit matches flip-flop groups against one another. The flip-flop read circuit sends answers after reading miscellaneous flip-flops in the CC. The order that uses these circuits specifies a transfer condition. If the transfer condition is met, the next gating pulse will be a CTR. If the transfer condition is not met, the next gating pulse is an EPO.

10.2.3 Parity-Check Circuits and Error-Correction Circuits (Fig. 10-10)

These circuits were partly covered in the preceding section where we talked about what they did. Now, we'll discuss how they do it.

The order in the order word register is checked for parity (an even number of 1's in the order word). If the check reveals a parity failure (PF) by both the CC's, one of two paths may be taken, depending upon the order previously executed by the CC.

If the previous order was a decision order and the transfer condition was met, the gating pulse control's next output pulse is a CTR. The CTR causes the order in the OWR to be discarded, and its FSS address is stored in the return address register. The FSS transfers to the new address sent by the CC, and the CC follows the new program sequence.

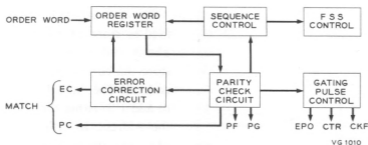

FIG. 10-10. Parity-check circuits and error-correction circuits

If the previous order in the OWR was a nondecision order, or a decision order resulting in no transfer, the parity failure causes a CKF in the CC, and the CKF starts the error correction circuit in each CC to correct the order word. After the word is corrected, a parity good (PG) signal is forced from the parity check circuit, and an EPO is generated by the gating pulse control. The sequence control stops all normal system action of the CC until the error correction is completed. It also stops any orders to the FSS control circuit.

When a parity check indicates PG from one CC, and PF from the other CC, the gating pulse control sends out a CKF. This CKF starts the fault-checking routine to determine which CC is at fault. If the active CC checks faulty, it is put in the stand-by state.

10.2.4 Internal Flip-Flop Groups of the Central Control (Fig. 10-11)

These are the storage groups or registers within the CC. Some have specific uses and others store information that will be used later. Also shown in Fig. 10-11 is the BUS. Before discussing the registers, let's talk about the BUS. The BUS is an electronic switching device for interconnecting two or more equipment elements over a relatively large number of leads. It is similar to "connectors" in electromechanical systems. It may also be compared to a highway with many exits and entrances. You can get on the highway if its entrance gate is open. You can get off, similarly, if its exit gate is open. In the CC, the BUS is the highway. The internal and external flip-flop groups are the entrances and exits. Some have two-way access. Information is transported over the highway (BUS) by opening entrance gates one at a time to get the information to an exit, and opening an exit gate at the same time.

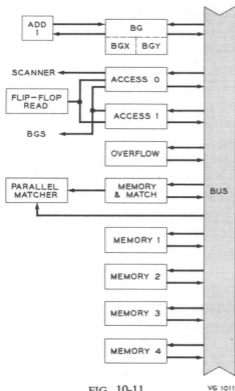

FIG. 10-11.
Internal flip-flop groups or registers.

The BGS ADDRESS REGISTER is used to store addresses for the BGS. The X and Y halves of the register store the corresponding parts of the address. The "add 1" circuit is used to add 1 to either the X or Y half of the address. In orders for the BGS, like RYO, the Y part of the BGS address is given in the order. The X part of the address was previously put into the X half of the BGS ADDRESS REGISTER by some previous order. In programming, this is called presetting an address or part of an address.

The ACCESS REGISTERS (0 and 1) are the most widely used registers shown on Fig. 10-11. Translation word information is always put into an access register from the OWR. And, since two readings of sixteen bits each are always made, both access registers are always used.

These registers have the following features that no other register in the CC has:

- (1) The access registers are used to convert serial information into parallel information, and *vice versa*. For example, the BGS sends to the CC one bit at a time, which is stored in an access register. When the CC has all the information stored in the access registers, it takes the information out of the access registers all at once.
- (2) The CC can change one bit of information in an access register without involving or affecting any of the other fifteen bits.

Both access registers are also used for shuffling information to other registers in the CC via the BUS. For example, addresses for network points and for trunks assigned to the SD (signal distributor) output points are set up in the access registers, and then gated to the appropriate unit register. The scanner addresses are always sent from ACCESS REGISTER 0.

The OVERFLOW REGISTER, as its name implies, is used when the number of bits of information for some other register exceeds the capacity of that register. The overflow register is also used by the CC as a miscellaneous register.

The MEMORY REGISTERS (1, 2, 3, and 4) are general storage registers for the use of the programmer. Memory registers 1 and 2 can each store sixteen bits of information. Memory registers 3 and 4 hold eight bits each.

The MEMORY AND MATCH REGISTER is used as a general storage register for sixteen bits of information. It is also used to store information that will be used by the parallel matcher to match it against another register to find out whether both registers contain the same information. For example, on an abandoned call that has progressed as far as ringing, the system starts to release the connection. It gets to the ringing trunk connection on the network, and then it doesn't know whether this is just a ringing connection or a talking path. So the system puts the network address of the ringing trunk into the memory and match register. The system then matches the network address of this ringing trunk against the addresses of the ringing trunks in all the ringing registers. If the system gets a match, it knows that the ringing trunk was not being used as a talking path. The system then releases the ringing trunk and makes the ringing register idle.

The FLIP-FLOP READING circuit allows the system to read information in any flip-flop of the access registers or in some miscellaneous flip-flops of the CC. To carry out its functions, the system must often find out the state of a particular flip-flop or group of flip-flops. For example, suppose that the system gives an order to a network. When the network finishes its task, it sends an answer to the CC which puts information into the "operation ended" flip-flop. Every so often the program tells the CC to read that flip-flop. When it is in one state, the system knows that the network has completed its task. When it is in its other state, the flip-flop tells the system that the network hasn't finished its task.

10.2.5 *External Unit Registers within the Central Control (Fig. 10-12)*

All these registers store information for the units with which they are associated. Since information is gated to these circuits over the BUS in the CC, it takes at least two program orders to fill these registers. Information is then sent to the unit with which the register is associated. Some of these registers send their information through the stand-by transfer to the other units. The

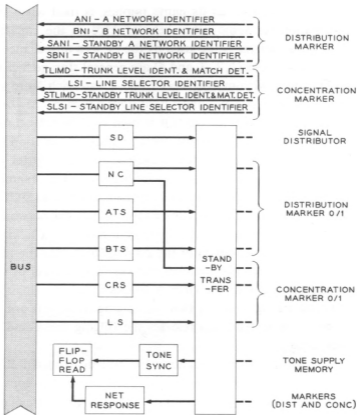

SD - SIGNAL DISTRIBUTOR
 NC - NETWORK CONTROL
 ATS - A TRUNK SELECTOR
 BTS - B TRUNK SELECTOR
 CRS - CONCENTRATOR RELEASE SELECTOR
 LS - LINE SELECTOR

VG1012

FIG. 10-12. External unit registers within the central control.

stand-by transfer, as mentioned previously, sets up transfer paths between the active and stand-by CC, and the active and stand-by markers and SD's.

The SD (signal distributor) REGISTER sends addresses and enable pulses to the signal distributor.

The NC (network control) REGISTER sends orders (connect, release, trace, etc.) to the markers.

The ATS and BTS ("A" trunk selector and "B" trunk selector) REGISTERS send addresses to the markers for making connections to the A or B side of the network.

The CRS (concentrator release selector) REGISTER sends addresses for connections to be released at the concentration network.

The LS (line selector) REGISTER sends addresses for connections to be set up at the concentration network.

The NETWORK RESPONSE circuit accepts signals from the markers. For example, the system gives a network a task via the CC. The CC then goes on with other office business. When the network finishes the task, it sends back a signal called "operation ended" to the network response circuit in the CC. Every so often the program tells the CC to read the flip-flop that receives the "operation ended" signal. Thus the system learns whether the network has finished its task. The marker also returns a signal to the CC that tells what the result was—"busy," "successful," or "trouble." These answers also go to the network response circuit. Again the system determines the next move by reading through the flip-flop reading circuit the answers returned by the marker.

The TONE SYNCHRONIZATION circuit receives from the tone supply memory (in the stand-by transfer), signals that tell it there is a tone being sent out and what that tone is. The CC has access to this information via the flip-flop reading circuit.

The eight lines with the arrows pointing to the BUS represent groups of leads coming from the markers. When an order and address are sent to a marker, the marker returns the same address to the CC on one group of leads. If the system wants to match an address sent to the marker with the address returned from the marker, it can do so. The reason for these groups of leads coming right into the BUS in the CC is that the BUS provides access to other registers for this information, if it is necessary.

10.2.6 Repeat-Order Circuits (Fig. 10-13)

A "repeat" order in the program tells the CC to execute the next order a certain number of times. The next order specifies what to do and the first location for where to do it. The repeat-order circuits in the CC take over and, in a sense, manufacture orders by modifying the address for the repetition.

The maximum number of repeats that can be specified on any individual order is 32.

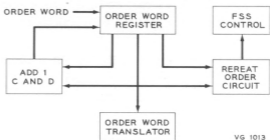

FIG. 10-13. Repeat-order circuits.

When a “repeat” order enters the order word register and is translated by the order word translator, the repeat order circuit is alerted so that the following order will be executed a certain number of times. A counter is set to indicate the number of repeats. After the next order is executed, the FSS control receives no more orders for the FSS. The counter is reduced by one; the ADD 1 C & D circuit changes the address part of the order in the order word register; and the order in the OWR is executed. This pattern is followed until the counter runs out or a decision order transfer condition is met.

Let’s assume that the system must write twelve 1’s in a BGS register. The program specifies first, a “repeat” order that the next order be repeated twelve times. The next order tells the CC to have the BGS write a 1 at the location specified by the Y-part of the address, with the X-part preset. The repeat-order circuits take over after the first order is executed. They follow the pattern explained previously until the twelve 1’s are written. Then, the next clock pulse causes a transfer to the next program order.

10 . 2 . 7 Circuits Associated with the Scanner (Fig. 10-14)

When the system program calls for communication between the CC and the scanner, the circuits shown on Fig. 10-14 control this exchange of information. The scanner is a little slower in operation than the CC, and two types of program orders are used to compensate for the difference in speeds. One type is an “enable scanner” order which prepares the scanner for readings by the CC. This order is used every time the Y-part of the scanner address is changed. The second type, a “read” order, tells the CC to read the scanner’s answer for the condition of the line it just looked at.

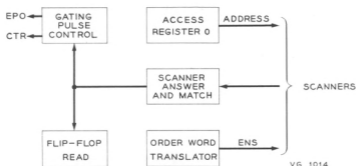

FIG. 10-14. Circuits associated with the scanner.

Address information for the scanners is always sent from ACCESS REGISTER 0 (A0). The enable scanner lead is activated by the OWT for the scanner.

The scanner is continually inspecting lines and returning answers to the CC. All these answers go to the SCANNER ANSWER AND MATCH circuit. This circuit stores scanner answers for the CC. It also matches answers from the two circuits when matching is called for. The matched answers are sent to the FLIP-FLOP READ CIRCUIT, where they can be read by the CC.

“Read scanner” orders tell the CC when to use these scanner answers. Depending upon the answer (0 or 1) the gating pulse control puts out an EPO or a CTR.

10.2.8 Circuits that Control BGS Operation (Fig. 10-15)

When program orders call for communication between the CC and the BGS's, the circuits shown on Fig. 10-15 come into play. As mentioned in Chapter 8, there are four BGS's used in the ESS. The ESS requires two working stores at all times. The other two are used as stand-by units. From now on we will talk about the two active BGS's. Since two stores are always active, we must have a way of directing them singly or both at once.

Let's start with both BGS's receiving orders from the CC and both returning answers to the CC as directed by the program. This is called “multi-tube mode” of operation. In multi-tube mode, the program may specify either of two types of decision orders for the BGS's—skip decisions or disjoin decisions. The CC recognizes a skip or disjoin order by the transfer register specified in the order

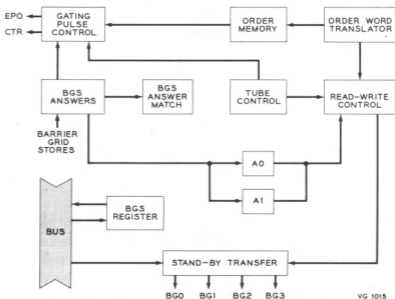

FIG. 10-15. Circuits associated with the barrier grid store.

word. Skip decision transfers specify transfer register 1, and tell the CC to transfer when all BGS readings meet the transfer condition. Disjoin decision transfers specify transfer register 2, and tell the CC to transfer if one or more BGS readings meet the transfer condition. A disjoin decision transfer always puts the system into the single-tube mode of operation.

The transfer registers are shown on Fig. 10-7 and explained in subsection 10.2.1.

Some of the circuits shown in Fig. 10-15 have already been described in other sections of this chapter. We will discuss them again here, however, in regard to their relations with the BGS's.

Let's assume that we have a disjoin decision order RY02 ("read and regenerate the BGS at the Y-address specified, the X-address preset; transfer if a 0 to the address stored in transfer register 2") in the order word register. The order word translator translates the "what to do" part of the order. It activates leads in the CC that will execute the order on the next clock pulse. The OWT sends to the order memory the following pertinent order information:

- (1) Read the BGS's.
- (2) Transfer if the answer from one or more BGS's is a 0.
- (3) Transfer to the address stored in transfer register 2.

The order memory stores this information for use by the gating pulse control when the answers are returned by the BGS. The OWT tells the BGS read-write control to read the BGS. The tube control circuit tells the BGS read-write control to read all active tubes; so the BGS read-write control sends the order to all tubes via the stand-by transfer. The order word translator puts the Y-part of the address on the BUS, and the X-part of the address is gated out of the BGS address register onto the BUS. The BUS is directly connected to the BGS's, and on the next clock pulse the order is executed. The BGS's return their answers to the BGS answer circuit, which stores these answers. On a disjoin decision order if one BGS answer is a 0, the tube control circuit is signalled. It then tells the read-write control to work only in that tube (single tube mode).

Again the access registers (A0 and A1) are used when the system wants to take one bit of information at a time from the BGS, store it in an access register, and then read it out all at once. It (the system) can also put information into the access registers all at once and send that information bit-by-bit to the BGS.

10.3 POWER

The primary power of the central control is 230 volts, 60 cycles. Power bus A supplies CC-0; power bus B supplies CC-1. Each central control is protected by two 5-ampere and two 9-ampere circuit breakers in the power distribution cabinet (one per cabinet).

Bulk rectifiers, 37 in each central control, provide filtered d-c voltages of +26, +22, +16, +8, -4.5, -5, and -16 volts to the central control circuits. You can see the arrangement of this equipment in Figs. 10-1, 10-2, 10-3, and 10-4. The rectifiers are of two types: J-86287A, L1, for voltages from 0 to 10 volts, and J-86287A, L2, for voltages from 11 to 26 volts. In each case the rectifier is adjusted to its specified voltage. This voltage is marked on the designation strip. These rectifiers are pictured in Fig. 5-20. Both types look exactly alike except for marking. They are plug-in units, secured to the mounting plate with quarter-turn fasteners. They furnish their rated voltage at currents up to 3 amperes, with inputs of 226 to 233 volts, 57 to 62 cps. A circuit breaker in each rectifier protects the rectifier bridge from overloads.

Each bulk rectifier is connected to its load through several "isolation keys." These permit us to remove certain load circuits, one at a time. This aids in trouble shooting. All isolation keys are mounted on plates just below the rectifiers (see Fig. 10-4).

There is a +4v voltage regulator in each central control. It provides $\pm 1\%$ regulation at loads up to $\frac{1}{4}$ ampere. Each regulator consists of two circuit packages (F-52659 and F-52660) at locations 423J and 423L.

Each central control also has three tracking regulators, each of which is assembled as an F-52656 circuit package. They provide a 6.5-volt output that tracks 1.5 ± 0.1 volts below the +8v input at a current of $\frac{1}{4}$ ampere maximum. They are found at locations 222AA, 423N, and 423Q.

Ninety-two "isolation network" packages are used in each central control. They provide extra filtering of the d-c power, and removing them isolates their load circuits.

The clock pulse power supply is located in bay 5. It provides the following voltages to the circuits indicated:

	<u>Voltage</u>	<u>Circuit</u>
	6.3v a-c	Clock Pulse Generator* and Amplifier (Filament)
<i>Regulated</i>	+ 150v d-c	Clock Pulse Generator* and Amplifier (Screen)
	+ 250v d-c	Clock Pulse Generator* and Amplifier (Plate)
	+ 400v d-c	Clock Pulse Amplifier (P. A. Plate)

Relays in the clock pulse power supply prevent plate or screen power from being applied to the tubes in the pulse generators and amplifiers until the filaments have warmed up. They also prevent screen power from being applied unless plate power is present. A circuit breaker in the input circuit protects the supply from overloads.

10.4 MISCELLANEOUS

There are several 276-F plug-in mercury contact relays in the CC. These are used for monitoring certain power applications.

Relays DD-0 and DD-1 are located on plate 424 of CC-0 and CC-1 respectively. They are normally operated by the +16G power supply through key +16G4. Failure of this power, either in the bulk rectifier or in the main a-c supply, will cause the relay to release. If this occurs in the *active* CC, the relay action will cause the control and indicating circuit in the administration center to take the faulty CC out of service and put the stand-by CC into service, and to light the proper alarm lamps. Should the *stand-by* CC be affected, it will be "made busy" and the alarm lamps will be lighted.

*Located in the stand-by transfer.

Relays marked RFA are located on plates 222 and 424, and relays RFC and RFD on plate 424. These operate blown fuse alarms. The RFA relays indicate blown fuses in the +8v circuits feeding certain +6.5v tracking regulators. The RFC relays indicate blown fuses in the +8v circuits feeding other +6.5v tracking regulators and some +4v regulators. The RFD relays indicate blown fuses in the -16v circuit feeding a +4v regulator. These relays are operated when the type 70 fuses blow and force their end caps against the alarm terminals of the fuse blocks.

There are test blocks located on each bay. Each block contains four test posts, designated +22G, +22CP, GRD, and HRG. Bays 1, 3, 5, and 7 have test blocks mounted on both front and rear. The +22G is connected to the +22v supply through a 3830-ohm resistor; the +22CP is connected to the +22v supply through a 2610-ohm resistor; and the HRG is connected to ground through a 12,000-ohm resistor.

Feed-through terminal strips are mounted at plate location 30 on bays 1, 3, 5, and 7, and at location 29 on bays 3 and 7. These provide junctions for inter-cabinet wiring. They also furnish access points for testing.

Coaxial connectors are mounted on plate 32 of bays 1, 3, 5 and 7. These connect to cables for the inter-cabinet transmission of clock pulses.

Bay 7 contains a number of connectors used for a portable manual test circuit (a "T-cart"). This is a manually operated substitute for the flying spot store. Its connections to the system are via the CC, bay 7. On plate 700, coaxial connectors marked PPF, RES, INS, and EXEC, and multi-contact connectors marked MPP, MTA, and MTB are for this purpose. Some contacts of these connectors are wired directly to pin jacks in the CC. You will find these jacks mounted on plates directly behind the isolation keys on each hinged bay. Special test leads plugged into these jacks can be clipped onto any desired place in the central control circuit. This gives the "T-cart" access to any point in the CC as needed. A 230-volt, 3-wire receptacle located in the base of bay 7 provides power to the "T-cart."

Another item of test equipment connected to the central control is the central control automatic tester (CCAT). Connectors for it are mounted on the side of bay 0 near the top. Mating cable-mounted connectors, wired into the central control, are normally plugged into connectors marked "FSSI-A" and "FSSI-B." When the CCAT is used, these connections are broken and the connectors are plugged into the connectors marked CCAT-A and CCAT-B, respectively. There are eight other connectors involved with the CCAT. Their fixed portions are

mounted in the bottom of the cabinets behind bays 2, 4, and 6. They are marked CC1 through CC7, and CCS. Mating portions are cable-mounted and are marked CT1 through CT7 and SCAT, respectively. These connectors are only mated when the CCAT is used. At other times they are disconnected, and their open ends are covered with plastic shields.

There are connectors in the central control for the tape plate preparation equipment. This is the equipment used in preparing new photographic plates for the flying spot stores. It is connected to the central control thru coaxial connectors EXP, RST, and TPPCK, and multi-contact connector PP. These are located on plate 700.

A multi-contact connector, marked UTS, is found on the left side of bay 7. This is used for a portable test equipment called "FSS parity failure detector circuit." When plugged in, this equipment uses the central control to check the flying spot store alignment.

Below the UTS connector are two coaxial connectors, marked RS-1 and RS-0. These are no longer used.

Below the test block on bay 7 are two keys. They are marked SXS and EXT CLK. The SXS key permits you to operate the flying spot store via the central control in one-at-a-time manually controlled steps. The EXT CLK key switches the system to an external pulse generator in the manual test circuit. This gives us a variable control over the speed of system operation.

We find many wire-wound resistors mounted on plates 124, 222, 223, 523, and 721. Those marked with *two*-letter or *three*-letter code groups are voltage-divider resistors in the d-c power circuits. These are associated with the marginal voltage testing circuit located in the stand-by transfer. Resistors marked with *four*-letter code groups are cable-terminating resistors used in clock pulse circuits. These resistors are wired through a type D terminal strip mounted on each plate.

The central control cabinets contain the alarm relays, alarm indicator lamps, and power receptacles common to all ESS cabinets; two cabinets also have jacks mounted near the alarm lamp. These are used for intercommunication between cabinets.

10.5 MAINTENANCE

Since the central control is completely duplicated, it will rarely, if ever, require in-service repairs. The system routinely checks the operation of the

active CC against the stand-by unit. If a repetitive mismatch is detected, the system at once goes into a fault-checking routine. This determines whether the trouble is in CC-0 or CC-1. The faulty unit is automatically taken out of service and "made busy" to the system; the alternate unit then runs the office. A red light in the administration center tells which unit is out of service, and the system starts a diagnostic test routine. This checks the out-of-service unit to locate the source of the trouble. A print-out on the teletypewriter tells us where to look for the fault. After repairs have been made, we must type a "restore" order into the teletype. This starts another fault-checking routine to make sure that the unit is OK before putting it back in service. If the unit checks OK, it is placed on stand-by and the trouble lamp is put out.

Emergency Alarm Timer Resetting Routine

To check the proper operation of the active system, a special program is used. Its end product is to reset the emergency alarm timer via the signal distributor. This occurs once every 100 milliseconds. If the timer is not reset, it will "time out," indicating that something prevented the program from resetting the timer. If the timer is not reset, the flying spot store, the central control, and the signal distributor will be switched from active to stand-by and vice versa. A diagnosis of the various units will then follow.

Repair Procedure

When trouble is indicated in a CC unit, its location is given within a certain area. Replacing all circuit packages or other conveniently removable units within that area should clear up the trouble. Table 10-2 (on page 292) lists the circuit packages used in the central controls.

WARNING Before doing any maintenance work in a central control unit, *always* put it in the "busy" (trouble) state!

"Continuous diagnosis" is a procedure that aids the maintenance man when the diagnostic print-out is not specific enough in pointing out the fault location. This is a diagnostic mode that performs all normal tests, but prints a record only when all tests pass. When a test fails, the phase of the diagnosis in which the failure occurs is completed; then the sequence stops, the CC trouble lamp lights, and the diagnosis repeats. The trouble lamp remains lighted for one-half second; it is out during the tests. We start this procedure by a teletype

TABLE 10-2. PACKAGES USED IN THE CENTRAL CONTROLS

The quantities shown are the totals for the duplicated units.

Designation	CPS* No.	Quantity	Name
F-52600	36	864	Transistor Flip-Flop
F-52601	46	816	Flip-Flop to Gate Amplifier
F-52603	48	476	Gate Amplifier
F-52604	49	102	Inverter Amplifier
F-52605	50	628	Emitter-Follower Amplifier
F-52610	146	2	Transistor Monostable Flip-Flop
F-52615	1	700	AND Gate, 2-2-2-2 Inputs
F-52616	2	468	AND Gate, 2-2-2-2-2 Inputs, with One Input Common
F-52617	3	540	AND Gate, 3-3-3 Inputs
F-52618	4	424	AND Gate, 3-3-3-3-3 Inputs, with Two Inputs Common
F-52619	5	98	AND Gate, 5-5 Inputs
F-52620	16	110	OR Gate, 1-1-1-1-1-1 Inputs
F-52621	17	152	OR Gate, 2-2-2-2-2 Inputs
F-52622	18	24	OR Gate (No Resistor), 10 Inputs
F-52623	19	46	OR Gate (2610-ohm Resistor), 2-2-2 Inputs
F-52624	20	88	OR Gate (2610-ohm Resistor), 2-3-3 Inputs
F-52625	21	8	OR Gate (2610-ohm Resistor), 10 Inputs
F-52626	22	216	OR Gate (3830-ohm Resistor), 2-2-2 Inputs
F-52627	23	88	OR Gate (3830-ohm Resistor), 2-2-3 Inputs
F-52628	24	170	OR Gate (3830-ohm Resistor), 2-3-3 Inputs
F-52629	25	100	OR Gate (3830-ohm Resistor), 4-4 Inputs
F-52630	26	174	OR Gate (3830-ohm Resistor), 10 Inputs
F-52631	155	184	Isolation Network
F-52633	51	80	Cable Pulser Amplifier
F-52634	156	172	Cable Matching Network
F-52656	195	6	Tracking Voltage Regulator, +6.5v
F-52659	189	2	+3v to +5v Voltage Regulator, Board A
F-52660	189	2	+3v to +5v Voltage Regulator, Board B
F-52663	154	16	Steering Network
F-52664	69	24	Cable Buffer Amplifier
F-52665	70	2	Shaper Amplifier
F-52666	158	2	16-kilocycle Crystal Oscillator
F-52667	153	16	Pulse-Shortening Network
F-52668	138	6	Delay Network
F-52669	148	4	Feedback Network
F-52670	181	12	Voltage Divider Resistors, 330 Ohms
F-52671	182	30	Voltage Divider Resistors, 510,000 Ohms
F-52672	41	30	Clock Coupling Network A
F-52673	42	40	Clock Coupling Network B
F-52674	43	22	Clock Pedestal Network

*CPS means Circuit Package Schematic.

Table 10-2 continued on page 293

TABLE 10-2. PACKAGES USED IN THE CENTRAL CONTROLS (continued)

Designation	CPS* No.	Quantity	Name
F-52675	198	16	Voltage Divider, 10,000 Ohms
F-52676	142	2	EPO Delay Network
F-52679	44	10	Clock Coupling Network C
F-52681	134	34	Voltage Shifting Network
F-52693	133	2	Bias Network
F-52696	258	2	Feedback Network B (Remote Concentrator Control Circuit)

*CPS means Circuit Package Schematic.

order; then we replace the packages in the trouble area, one at a time, making sure to leave each package in its socket for two successive flashes of the trouble lamp. When we have replaced the faulty package, the diagnosis will run to completion and a teletype print-out will indicate that all tests passed. The duration of a complete diagnosis is slightly over three seconds.

All circuit packages are plug-in units. The bulk rectifiers plug in and are held in place by quarter-turn fasteners. The clock pulse amplifiers are similarly mounted, but the quarter-turn fasteners are of the ring-handle type and are operated from the front of the bay. The clock pulse power supply rests on a mounting shelf and also is fastened with quarter-turn fasteners. The clock pulse equipment and power supplies also have rear-mounted connectors that connect them into the system.

WARNING The clock pulse amplifiers use voltages up to 450 volts d-c. Do not remove the protective shields nor stick your fingers or any tools into these units when the power is on!

Disconnecting a clock pulse generator or a clock pulse amplifier or an associated bias network will automatically disable the clock pulse power supply.

Isolation Keys

Some troubles that show up as power supply failures can be localized by using the isolation keys. When a fault causes the circuit breaker in a bulk rectifier to trip, you should open all the keys in that rectifier circuit and reset the breaker. If it trips again, the fault is in the bulk rectifier. If it does not trip,

you should check the breaker in the power distribution cabinet to make sure that *it* has not tripped. Then, by closing the isolation keys one at a time until the bulk rectifier breaker trips, you can locate the faulty circuit.

Voltage Monitor Test

An important means for detecting power supply troubles before they become serious is the voltage monitor test. This test automatically monitors the output of each CC power supply at regular intervals. If any output is found to exceed the specified limits, an alarm is sounded and a teletype print-out identifies the faulty unit. This test is also applied as the first step in the diagnostic test routine. A failure here stops the rest of the routine and gives the location of the fault.

Marginal Voltage Test

Another important tool of preventive maintenance is the marginal voltage test. This test checks the ability of certain critical circuits in the central control and stand-by transfer to operate properly under abnormal d-c voltage conditions. It is applied to certain flip-flops and gate amplifiers, which are grouped for this test. The test consists of applying a marginal voltage, which either adds to or subtracts from the normal d-c voltage (*adding* voltages are not applied to *flip-flop groups*, however). This voltage is applied separately to each group of packages in four discrete steps. The operation of these circuits is checked at each step. A teletype print-out indicates which groups passed the test, and which failed. When failures occur, the voltage margin at which the apparatus failed is also indicated. At the minimum margin, any package that fails to operate should definitely be replaced; at the maximum margin, a good package should still operate.

This test can be made only on the *stand-by* CC, for it is matched against the active CC that is handling office traffic. The marginal voltage test is programmed automatically once a day. A marginal voltage test can also be called for via the teletype. However, such a request must be followed, within 45 seconds, by another order, such as diagnosis of the central control. At the end of such diagnosis, or after the 45-second time-out, the marginal voltage is removed. A complete marginal voltage test for one central control and the stand-by transfer circuit takes about twelve minutes.

Chapter 11

Trunk Circuits

The ESS is connected to outside telephone facilities through a number of different kinds of trunk circuits. These include incoming and outgoing trunks to the No. 5 crossbar office, PBX tie lines, and one-way trunks to the 3CL switchboard. The trunking plan is shown schematically in Fig. 11-1.

The trunk circuits in the ESS are relatively simple compared to those in other switching systems. This is because the memory and logic functions are cared for in other parts of the ESS rather than in the trunk circuits.

The types, quantities, and drawing numbers of the trunk circuits initially assigned in Morris are shown in Table 11-1. The assignment of the trunks in the distribution switching network is covered in Chapter 3.

11.1 EQUIPMENT ARRANGEMENTS

The trunk circuits are mounted in two cabinets, designated T-0 and T-1. Each cabinet has a gate bay, designated 0, and a fixed bay, designated 1. Most of the equipment is mounted in the fixed (rear) bay, as shown in Fig. 11-2. Only one cabinet is shown in this figure, but the other one is essentially the same. In each cabinet, the gate (front) bay is empty, except for sixteen fuse blocks and two terminal strips.

The apparatus is mounted on standard mounting plates. Some apparatus is of the permanently-wired type and some consists of circuit packages. Identifying circuit numbers are stenciled on the mounting plates; bay and plate location numbers are stenciled on the bay frames.

Trunk power is supplied by four bulk rectifiers mounted at the top of each cabinet. The rectifiers in cabinet T-1 are supplied from the 230-volt a-c bus "B"; those in cabinet T-0 are supplied from the 230-volt a-c bus "C" (see Fig. 1-18). All rectifiers are of the plug-in type. Rectifier outputs are connected through fuses to the trunk circuits. Each set of four rectifiers supplies power to the trunks in its cabinet.

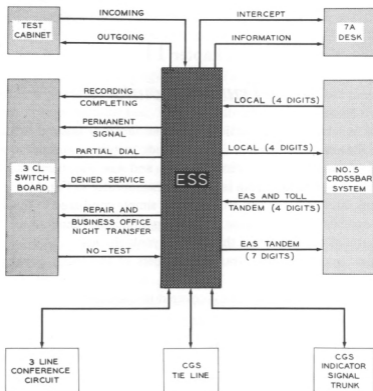

FIG. 11-1. ESS trunking plan.

VG 1101

Power is also supplied from the 48-volt battery of the No. 5 crossbar central office. Cabinet T-0 gets its power from d-c bus "B", and cabinet T-1 gets its power from d-c bus "C" (see Fig. 1-19).

Each group of trunks (such as incoming, outgoing, etc.) is divided in half: one half of the trunks are mounted in cabinet T-0 and the other half in cabinet T-1. Under this arrangement, a failure in either a-c bus or either d-c bus will affect only one half of any group of trunks.

TABLE 11-1. TRUNKS INITIALLY ASSIGNED IN THE MORRIS ESS

F-Spec. Number	CPS* No.	Drawing Number	Quantity	Trunk
F-52644	180	ES-1A054-01	13	Outgoing to 3CL Switchboard (Recording-Completing)
			3	Outgoing to 3CL Switchboard (Permanent Signal)
			3	Outgoing to 3CL Switchboard (Partial Dial)
			4	Outgoing to 3CL Switchboard (Denied Service)
			2	Outgoing to 3CL Switchboard (Repair and Business Office Night Transfer)
			1	Incoming from 3CL Switchboard (No-Test)
F-53323	271	ES-1A056-01	7	Three-Line Conference Circuit
F-52684	34	ES-1A061-01	5	Indicator Signaling
—	—	ES-1A060-01	39	Incoming from No. 5 Crossbar (Local)
			25	Incoming from No. 5 Crossbar (EAS and Toll Tandem)
			39	Outgoing to No. 5 Crossbar (Local)
			21	Outgoing to No. 5 Crossbar (EAS Tandem)
—	—	ES-1A055-01	3	Customer Group Service (CGS) Tie Lines
—	—	ES-1A059-01	2	Incoming from Test Cabinet
			2	Outgoing to Test Cabinet
—	—	ES-1A057-01	5	Outgoing to 7A Desk (Information)
			10	Outgoing to 7A Desk (Intercepting)
—	—	ES-1A065-01	10	Toll Termination
—	—	ES-1A055-01	1	PBX Toll Tie Line

*CPS means Circuit Package Schematic.

11.2 METHOD OF OPERATION

In the ESS, as in other systems, trunk circuits have two major functions. These are:

- (1) To provide talking paths.
- (2) To provide signaling links between the ESS and other offices or switching points.

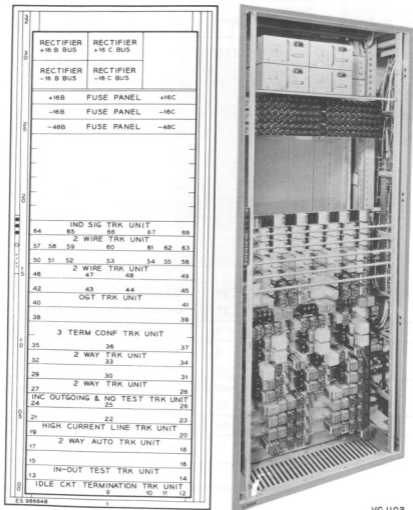

FIG. 11-2. Trunk cabinet, rear view and rear equipment.

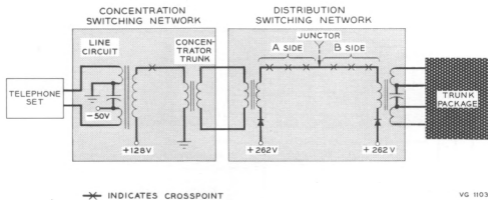

FIG. 11-3. Typical transmission path from a customer telephone set to a trunk.

The transmission path from a customer's telephone set is through the line circuit, the concentrator trunk, the distribution switching network, and then to the trunk circuit, as indicated in Fig. 11-3. For flexibility, several customers have access to each concentrator trunk. The concentrator trunks are equally divided, one half appearing on the A side of the distribution switching network and the other half appearing on the B side. Trunks have appearances on either the A or B side of the network, or both. Those trunks with only one appearance on the distribution switching network are referred to as single-sided trunks; those appearing on both sides of the network are called double-sided trunks.

11.2.1 Operator Call, Recording-Completing Trunk (Fig. 11-4)

When a customer dials the operator code zero, the signal distributor grounds the trunk TS lead, which in turn causes a lamp to light at the 3CL switchboard. When the operator answers the call, the trunk places a ground on the A lead to the scanner. This ground informs the ESS that the call has been answered. The talking path between the customer and the trunk circuit is then completed through the distribution switching network.

11.2.2 Trunk Connection to Two Sides of Distribution Switching Network (Fig. 11-5)

Normally, when this trunk is used as an incoming or outgoing trunk, it is connected to either the A side or the B side of the distribution switching

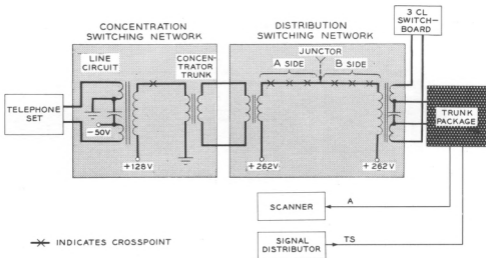

VG 1104

FIG. 11-4. Incoming or outgoing trunk to the 3CL switchboard, single-sided termination.

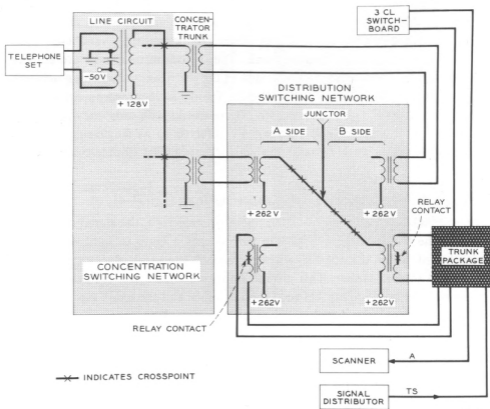

VG 1105

FIG. 11-5. Incoming or outgoing trunk to the 3CL switchboard, double-sided termination.

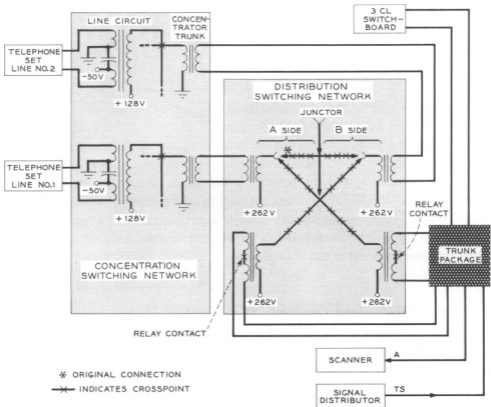

FIG. 11-6. Outgoing trunk from the 3CL switchboard arranged for no-test, double-sided termination.

VG 1106

network. To reduce the possibility of finding no paths, some trunks of each type are terminated on both the A side and the B side of the distribution switching network. The customer, through the concentration switching network, has access to both sides of the distribution switching network. Fig. 11-5 shows a connection between a customer on the A side and a trunk on the B side of the distribution switching network.

11.2.3 No-Test Trunks (Fig. 11-6)

A group of no-test trunks originates at the 3CL switchboard. These trunks are used by the operator to monitor or challenge on a line to determine whether the line is busy or in trouble. These trunks have both an A side termination and a B side termination. The operator can, by dialing a code and then

the directory number, cause the ESS to insert the no-test trunk into an already established talking connection. The original connection between the called and calling customers in the distribution switching network is then discarded, and a transmission path from line 1 is established through a concentrator trunk to the A side of the distribution switching network crosspoints and then to the B side crosspoints. From here it goes to the B side of the no-test trunk. This trunk also is coupled to the A side of the network. The transmission path then goes through the A side of the distribution switching network crosspoints to the B side crosspoints, and from there to the concentrator trunk to line 2. When the operator disconnects, and the no-test connection is removed, a separate connection is again established through the distribution switching network between lines 1 and 2. If the dialed directory number is not busy, the only connection set up is from the trunk through the distribution switching network to the concentrator trunk on either the A or B side.

11.2.4 Two-Way Trunk Circuit for PBX Tie Line (Fig. 11-7)

This trunk circuit is used to connect the ESS to a PBX tie line. The trunk operates with standard E and M lead signaling circuits between the ESS and a distant PBX. It performs the following major functions:

- (a) Transmits signals to the distant PBX.
- (b) Recognizes a seizure signal, dial pulsing signals, and supervisory signals from the distant PBX.
- (c) Provides a talking path from the distribution switching network to the trunk repeating coil group.
- (d) Removes the idle circuit termination when the talking path is set up.

Outgoing Call to Distant PBX

The trunk circuit is seized when a ground is placed on the TSA lead from the signal distributor. A relay in the trunk circuit operates and changes the ground on the M lead to battery. This constitutes a seizure signal to the connected CX signaling circuit which lights a lamp at the distant PBX. On an answer condition from the distant PBX, the associated CX signaling equipment places a ground on the E lead to the trunk. The ground passes through the trunk to the scanner A lead. It is recognized by the scanner as an answer signal. Now the system sets up the talking path through the switching network. At the time the talking

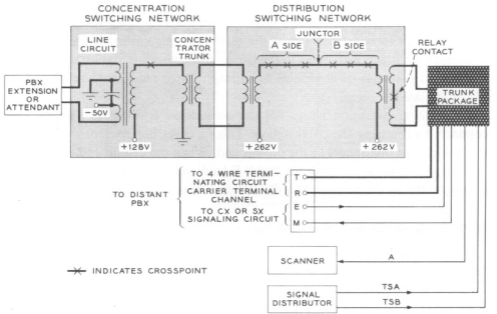

FIG. 11-7. Two-way trunk with E and M lead signaling for PBX tie line, single-sided termination.

path is set up, a ground is placed on the TSB lead from the signal distributor to operate another relay in the trunk. This relay removes the idle circuit termination from the trunk.

At the end of the call, if the distant end disconnects first, the ground is removed from the E lead. This restores battery to the scanner A lead, and is recognized as a disconnect signal. The signal distributor causes the M lead to change from battery to ground by releasing the trunk relay. If the calling end disconnects first, battery is removed from the M lead. This in turn causes a disconnect signal at the distant PBX.

Incoming Call from Distant PBX

When the trunk is seized at the distant PBX, ground appears on the trunk E lead. This ground is detected by the scanner as a seizure signal. When this ground is interrupted by dialing from the distant end, the scanner recognizes the interruptions as dial pulses. When dialing is finished, the ESS connects a ringing current to the called extension and an audible ringing tone to the

calling PBX. When the called extension answers, the ringing is tripped; now the signal distributor grounds the TSB lead to operate a relay in the trunk to remove the idle circuit termination. The signal distributor also grounds the TSA lead to operate the supervisory relay in the trunk. The operation of this relay changes the M lead potential from ground to battery. This is recognized at the distant PBX as an answer signal.

When either extension hangs up, the connection is released. The ESS disconnects by releasing the trunk relays. This removes battery from the M lead and indicates a disconnect to the distant end. When the distant end disconnects first, ground is removed from the trunk E lead and replaced with battery. This is recognized by the scanner as a disconnect signal.

11.2.5 Trunk Circuit to the No. 5 Crossbar Office (Fig. 11-8)

This trunk circuit is used to connect the ESS to the No. 5 crossbar office. The trunk circuit operates with the standard No. 5 auxiliary incoming or outgoing trunk circuits arranged to convert loop supervision to E and M lead supervision. This trunk can terminate on one or both sides of the distribution switching network. It performs the following major functions:

- (a) Transmits seizure signals, dial pulses, and supervisory signals to the No. 5 auxiliary trunk circuit.
- (b) Recognizes seizure signals, dial pulses, and supervisory signals from the No. 5 auxiliary trunk circuit.
- (c) Provides a talking path from the ESS distribution switching network to the No. 5 crossbar office auxiliary trunk circuit.

Outgoing Call

When the trunk is seized by the ESS, a ground is connected to the TS lead from the signal distributor. This operates the trunk relay, which places ground on the E lead toward the No. 5 crossbar equipment. A battery pulse is sent back to the ESS via the M lead and then to the A lead to the scanner. This battery pulse (*Wink*) on the A lead informs the ESS that the No. 5 crossbar equipment is ready to receive pulses. At the same time that the seizure signal is transmitted, the ESS sets up the talking path from the calling customer to the trunk circuit. Dial pulses on the TS lead from the signal distributor now operate and release the trunk relay at the dial pulse rate. Dial pulses are sent to the No. 5 crossbar equipment over the E lead. When the called customer answers, battery is sent back to the ESS over the M lead and then over the A lead to the scanner. This is

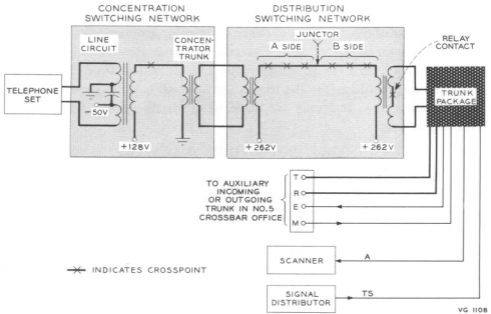

FIG. 11-8. Incoming or outgoing trunk to No. 5 crossbar office with E and M lead signaling, single-sided termination.

recognized as an answer signal. The battery is removed from the A lead to the scanner when the called customer disconnects. The signal distributor now releases the trunk relay. This removes the ground from the E lead and causes the release of the No. 5 crossbar equipment. When the called or calling customer hangs up, a disconnect signal is sent in the opposite direction.

Incoming Call

When the trunk circuit is seized by the No. 5 crossbar equipment, battery appears on the M lead and then on the A lead to the scanner. After an interval of time, the No. 5 crossbar equipment starts outpulsing. These dial pulses (battery interruptions) are detected by the scanner on its A lead. After central control has received the necessary information, it sets up the ringing connection to the called customer. When the called customer answers, the talking path between the ESS distribution switching network and the No. 5 crossbar office is set up. Now the signal distributor causes a ground to be put on the E lead toward the No. 5 crossbar office. This signal serves as an answer signal to the No. 5 crossbar equipment. Disconnect is handled in the same manner as described for the outgoing call.

11.3 MAINTENANCE

Because of the simplicity of the trunk circuits, maintenance is quite easy.

Trunks are taken out of service or restored to service via instructions to central control from a teletypewriter at the administration center. The detailed maintenance procedures for the trunks are covered in their respective circuit descriptions (CD's). Test calls are made to the trunk circuits from the ESS local test cabinet.

Chapter 12

The Administration Center

The Administration Center (AC) is the maintenance center for the ESS. Here you receive all maintenance instructions for the system in the form of teletype messages and alarm signals. A general view of the AC is shown in Fig. 12-1.

The administration center includes two teletype machines. Normally, all trouble indications are recorded on one of these machines, and all traffic information is recorded on the other. If necessary, however, one machine can handle both the trouble indications and the traffic information. Either of these two machines can be used in place of the other by operating certain keys on the machine.

12.1 EQUIPMENT ARRANGEMENTS

The administration center is made up of a console and two cabinets, as shown in Fig. 12-1. The cabinets are designated AC-0. On the console are mounted the two No. 28 teletype machines. The lower part of the console includes a typing reperforator for recording the message on teletype tape (see Fig. 12-2).

Front Bay 0—Fig. 12-3

Bay 0, a front bay, contains a display panel, in the upper part. Lamps in this panel indicate the status of all duplicated control circuits. A white lamp indicates the unit that is in control; a unit in standby is not indicated. A red lamp indicates a unit in trouble. Below the display panel is a strip of thirteen transfer keys. You use these keys to transfer control to a duplicated unit, or to make a duplicated unit busy, when the teletype order fails to perform this function.

Below the control keys are five strips of ten alarm lamps each, and alarm control keys. You use these for various office alarm conditions. To the left of



FIG. 12-1. Administration center, front view.

VG 1201

these keys and lamps is a dial telephone set. By operating keys, you can connect to any one of ten talking lines.

Bay 0 also contains the power panel for the teletypewriter and the marginal voltage control.

Rear Bay 1—Fig. 12-4

Bay 1, at the rear, contains marginal voltage control relays, and control and indicating relays. It also contains teletype control relays, and control and indicating power circuits.

Front Bay 2—Fig. 12-5

Front bay 2 contains power rectifiers mounted at the top. Voltages of +22, +16, and -16 volts are provided by duplicate rectifiers operated in parallel. Under trouble conditions, you can remove one of the units. Voltages of +7.5 and -4.5 volts are provided with single rectifiers; these are used in test circuits. The lower portion of this bay has the FSS exposure address and plate verification unit.

Rear Bay 3—Fig. 12-6

Rear bay 3 contains the voltage monitoring circuit. This circuit consists of four crossbar switches, a selector, a voltage detector, a voltage divider, and a voltage reference transfer.

Figures 12-2 through 12-6 are shown on pages 310 through 314. The text of Section 12.2, Method of Operation, starts on page 315.

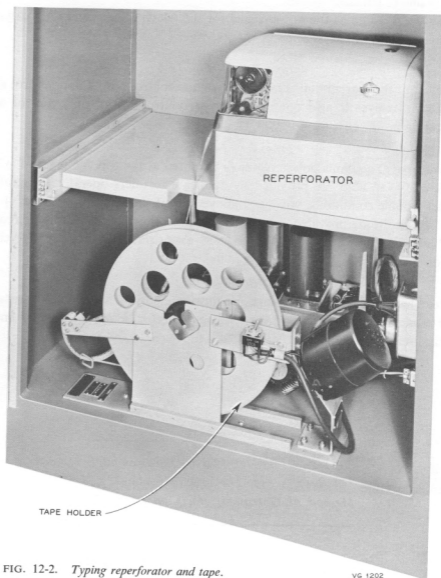

FIG. 12-2. *Typing reperforator and tape.*

VG 1202

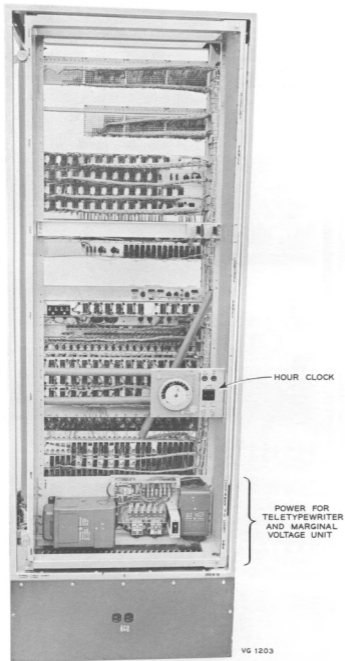

FIG. 12-3. Cabinet ACO, front view, Bay 0.

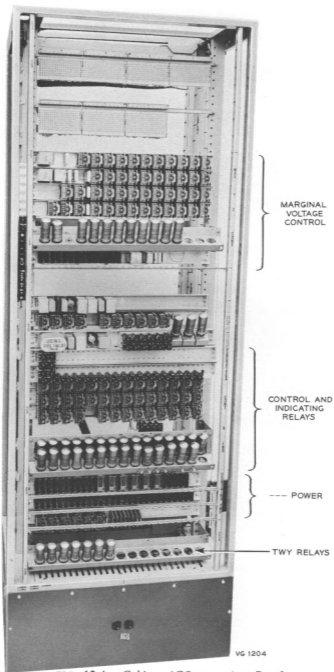

FIG. 12-4. Cabinet ACO, rear view, Bay 1.

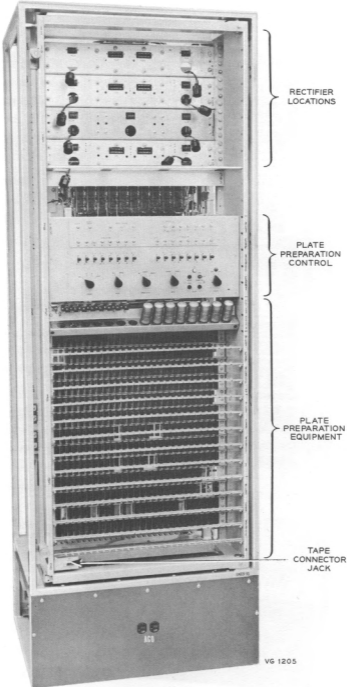

FIG. 12-5. Cabinet ACO, front view, Bay 2.

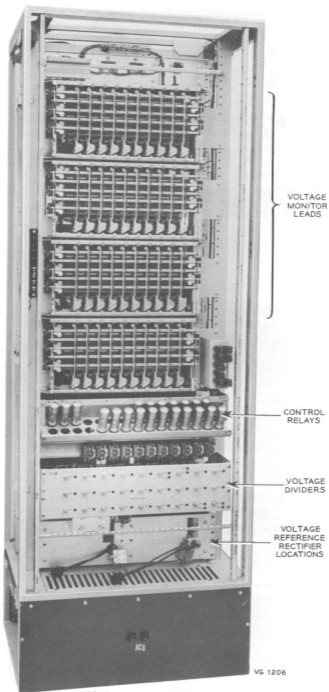

FIG. 12-6. Cabinet ACO, rear view, Bay 3.

12.2 METHOD OF OPERATION

Teletype Machines

Either of the No. 28 teletype machines can be used in place of the other by operating keys at the machines. Machine No. 1 is normally used for trouble reports. Machine No. 2 is normally used for traffic reports. When one machine is out of service, all data (both trouble data and traffic data) are recorded on the machine in service.

Some other functions of the teletype machines are listed below:

- (1) Entering recent change orders on the barrier grid store (BGS). These may be new customer and trunk order changes stored until the flying spot store (FSS) plates are changed.
- (2) Making up plate preparation orders for the flying spot store (FSS).
- (3) Entering orders to make line and trunk circuits busy.
- (4) Entering orders to transfer duplicate control circuits that operate on a matching basis.
- (5) Issuing orders to make these duplicate control circuits busy and to routine them for locating trouble, as well as issuing orders to restore the circuits to matching operation.

Dictionary

The dictionary is a book that explains the method of reading trouble records. A few examples are given below. All trouble records are preceded by the symbol ▲ (trouble). The next three characters indicate the major unit. The code used is as follows:

<i>Code</i>	<i>Explanation</i>
▲ DC 0 or DC 1	Central Control (CC)
▲ DF 0 or DF 1	Flying Spot Store (FSS)
▲ DS 00 or DS 01	Scanner 0 (S-0)
▲ DS 10 or DS 11	Scanner 1 (S-1) } <i>address circuit duplicated</i>
▲ DD 0 or DD 1	Signal Distributor (SD)
▲ DN 0 or DN 1	Distribution Marker (DM)
▲ DK 0 or DK 1	Concentration Marker (CM)
▲ DA 0 or DA 1	PBX Announcing Drum

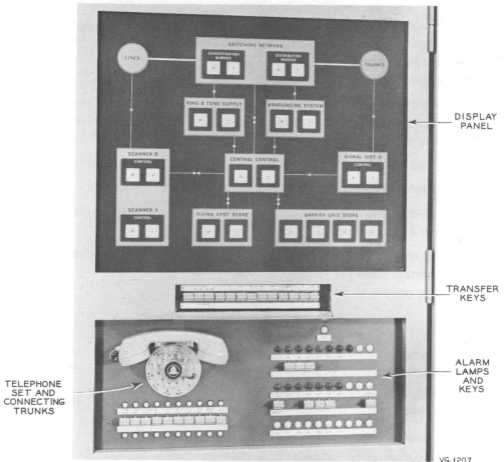

FIG. 12-7. Administration center display panel and associated equipment.

<i>Code</i>	<i>Explanation</i>
▲ DB 0	Barrier Grid Store 0 (BGS-0)
▲ DB 1	Barrier Grid Store 1 (BGS-1)
▲ DB 2	Barrier Grid Store 2 (BGS-2)
▲ DB 3	Barrier Grid Store 3 (BGS-3)

Display Panel—Fig. 12-7

Each major circuit has two lamps at the display panel. The active unit has its white lamp lighted. A unit in trouble has its red lamp lighted. A unit in the stand-by condition has no lamp lighted.

Alarm Panel

There are five strips of ten alarm lamps and associated release keys. They cover major alarms, minor alarms, power distribution alarms, and other alarm conditions. These are described in detail in the circuit description for the miscellaneous circuits. A general description of the ESS alarm system is given in Chapter 15; the alarm panel is shown in Fig. 15-2.

Control Panel

A manual means of taking equipment out of stand-by operation is provided. You can make any unit busy with a key. However, these keys are to be used *only* when the teletypewriter order fails to function.

Program orders also change the active and stand-by units automatically.

Communication Center

A telephone handset and dial enable you to communicate with any one of ten other locations by operating one of ten keys.

Voltage Monitoring

The voltage monitor circuit provides an automatic diagnostic tool that monitors about 800 voltage checkpoints distributed throughout the ESS. Under control of the system test program, it monitors the voltages at these checkpoints on a routine basis. It takes about fifteen minutes to complete the monitoring cycle, provided that the test program is not interrupted. If the voltage monitor detects a difference between the voltage at the checkpoint and the reference voltage in the monitor, a teletypewriter print-out tells you of the difference.

The voltage monitor is also called into action when the system starts a diagnostic program. When this occurs, the routine testing of the checkpoints is stopped and the monitor is immediately told to check the voltages of the circuit under test. The results of this check, OK or trouble, are given in a teletypewriter print-out. On completion of the diagnostic work, the program directs the voltage monitor back to its routine voltage-checking job.

If the reference voltage supply in the monitor fails, it is automatically switched to its stand-by supply. A lighted VMR lamp at the administration center indicates the switch. By the use of a transfer and reset key, the reference voltage supply can be controlled manually.

Records

The teletypewriter produces printed records of all alarm (trouble) conditions. These records are to be filed daily in time sequence in a binder, which then becomes the office record for the day. A similar binder is to be used for the monthly record.

The traffic information which is recorded by the teletypewriter is kept by the traffic department.

Defective Packages

The routine outlined in Specification X-63941 for handling defective packages should be followed.

12.3 MAINTENANCE

Switching

The ESS has a built-in self-checking feature for all common-control circuits. Line and trunk circuits must be checked periodically to ensure that they are in working order. The heart of the self-checking feature is the matching circuits in the two central control circuits.

The first mismatch causes an error signal to be printed with a record of the equipment in trouble. A second mismatch causes a fault-checking test to determine whether the active circuit or the stand-by circuit is in trouble. If the active circuit is in trouble, the system places the stand-by circuit in control. Then it starts a test on the circuit in trouble to locate the defective or faulty package. In some cases, several packages may have to be replaced to find the defective one.

The parts of the signal distributor, scanner, and switching networks that affect only one line or trunk are not duplicated, as failures in such parts should not affect a group of equipment. The address equipments of the scanner, the signal distributor, and the marker are duplicated, however, as trouble here would involve a large number of customers. The duplicate equipment is matched continuously, and an automatic transfer takes place under trouble conditions. A diagnostic routine establishes the source of the trouble as one of several packages in one limited area of the circuit.

The dictionary is used to interpret all teletypewriter messages. The trouble record, when decoded, directs you to the cabinet and the specific location within the cabinet where you will find the packages that include the defective or faulty one. When you have replaced the specified packages, an order to the teletypewriter requests a test of the major unit. If the test is successful, the major unit is restored to the stand-by condition.

You must replace promptly any major unit that is in trouble, as a second failure may affect service.

Ringling and Tone

The transfer of ringling supply units cannot be done by teletypewriter orders, as programmed transfers cannot be made for these units.

The ringling and tone supply units have their own checking circuits. Unit 0 is the preferred unit. It is always in operation unless it develops trouble; when this occurs, operation is transferred automatically to unit 1. If unit 1 develops two troubles and unit 0 has only one trouble, operation is automatically transferred to unit 0.

You also can use the manually-operated transfer key to put unit 1 in service and to keep unit 0 out of service. Don't leave this key operated after you have finished work on unit 0, as the automatic transfer of the units is inhibited while the key is operated.

Chapter 13

The Ringing and Tone Supply

Several different tones are needed to indicate the status of a call in any dial telephone system. The ESS uses transistor oscillators to generate such tones. A group of binary counters provides the interruption signals. These are mixed with the tones in gated amplifiers to produce interrupted tones. The tone output leads are distributed throughout the switching networks for access by the system.

13.1 EQUIPMENT ARRANGEMENTS

The ringing and tone supply cabinet, designated RT, consists of two bays, a front (gate) bay and a rear bay. The front bay (see Fig. 13-1) contains ringing and tone supply 0 and its rectifier units. It also contains all lamps and equipment common to both supply 0 and supply 1. The rear bay (see Fig. 13-2) contains ringing and tone supply 1 and its rectifier units.

13.2 METHOD OF OPERATION

Tone Generators—Figs. 13-3 and 13-4

Twelve transistor oscillators supply the tone signals for the ESS. Their frequencies range from 430 cycles per second to 1,000 cycles. Eight of these oscillators (see Fig. 13-3) supply the ringing tones. The remaining four (see Fig. 13-4) are wired as two pairs, the output of each pair being a combination of two frequencies. These supply the audible ringing tone, the dial tone, the reorder tone, and the busy tone.

Interruption Timing—Fig. 13-5

The interruption timing supply consists of a group of binary counters and amplifiers. It converts 1000-cycle sine-wave current to 1000-cycle square-wave current. The square-wave current is used to trigger the binary counters. The outputs of the counters are: 12.5 pps (pulses per second), 15 ipm (interruptions per minute), 120 ipm, 60 ipm, and 62.5 ipm. Some of these outputs are

combined; all are amplified. The outputs of the NIG amplifiers (see Fig. 13-5) are: 12.5 pps; 15 ipm and 12.5 pps; 15 ipm; 120 ipm; 60 ipm; and 12.5 pps and 62.5 ipm. The outputs of the IG amplifiers are used for the synchronizing signals to the central control.

Dial Tone—Fig. 13-4

The dial tone (a steady tone) is a combination of two frequencies, 560 cycles and 690 cycles. It is supplied to fifteen tone points in the distribution switching network.

Busy Tone—Fig. 13-4

The busy tone is a combination of two frequencies, 560 cycles and 690 cycles, interrupted at a rate of 60 ipm (0.5 second *on*, 0.5 second *off*). It is supplied to fifteen tone points in the distribution switching network.

Reorder Tone—Fig. 13-4

The reorder tone is a combination of the same two frequencies, 560 cycles and 690 cycles, interrupted at a rate of 120 ipm (0.3 second *on*, 0.2 second *off*). It is supplied to fifteen tone points in the distribution switching network.

Audible Ringing Tone—Fig. 13-4

The audible ringing tone is a combination of two frequencies, 430 cycles and 454 cycles, interrupted at a rate of 15 ipm (2 seconds *on*, 2 seconds *off*). It is supplied to five tone points in the signal switching network.

Ringling Tones—Fig. 13-3

The ESS serves eight-party lines on a selective ringing basis. Therefore it needs eight different frequencies of ringing tones. Each ringing tone is a single-frequency tone pulsed at 12.5 pps and interrupted at a rate of 15 ipm (2 seconds *on*, 2 seconds *off*). The eight tones are supplied to forty tone points in the signal switching network.

Revertive Ringing Tones—Fig. 13-3

Since the ESS serves two-party and eight-party lines, it needs ringing tones for reverting calls. These tones are single-frequency tones pulsed at 12.5 pps and interrupted at a rate of 62.5 ipm (0.48 second *on* and 0.48 second *off*). The revertive ringing tones are supplied to eight tone points in the signal switching network.

On the first ringing cycle, 0.96 second, the called party ringing tone is connected to the line. On the second ringing cycle, the called party ringing tone is

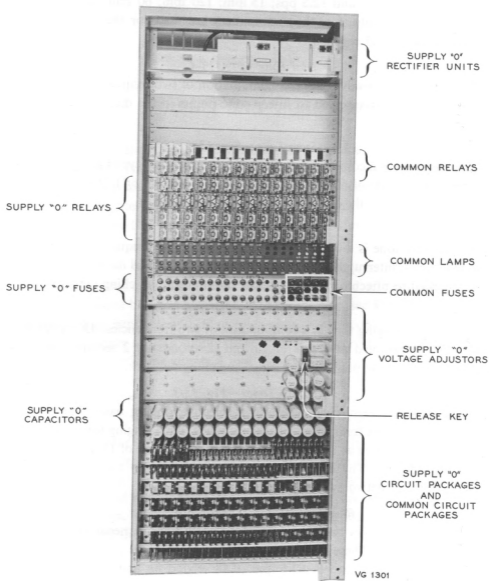

FIG. 13-1. Ringing and tone supply cabinet, front view of front bay (gate).

disconnected and the calling party ringing tone is connected. This alternating of the ringing tones for the called party and the calling party is continued until the called party answers, or until the connection times out and releases.

Local Test Cabinet Tones—Fig. 13-3

Eight tones are used by the ESS local test cabinet. Each tone is a single-frequency tone pulsed at 12.5 pps. These tones are supplied over eight leads to the local test cabinet.

CGS Signaling Tones—Fig. 13-3

Three steady tones (656 cycles, 810 cycles, and 1000 cycles) are needed for CGS signaling in the ESS. These tones are supplied to a maximum of fifteen indicator signaling trunks.

Alert Tones—Fig. 13-3

A steady tone of 591 cycles is used for the alert tone. It is supplied to twenty tone points in the distribution switching network, and to ten leads to the CGS auxiliary line circuits.

Synchronizing Signals—Fig. 13-5

Certain functions performed by the central control must be synchronized by signals from the interruption timing circuit. Twenty such synchronizing signals are supplied to the central control via the stand-by transfer.

Figures 13-2 through 13-5 are shown on pages 324 through 327. The text of Section 13.3, Duplication and Transfer, starts on page 328.

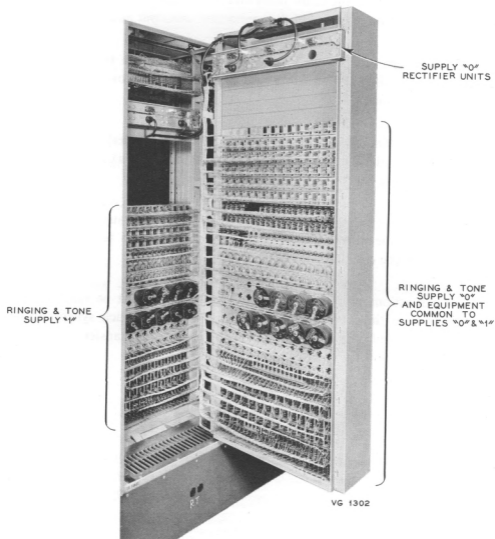

FIG. 13-2. Ringing and tone supply cabinet, rear views of front bay (gate) and rear bay.

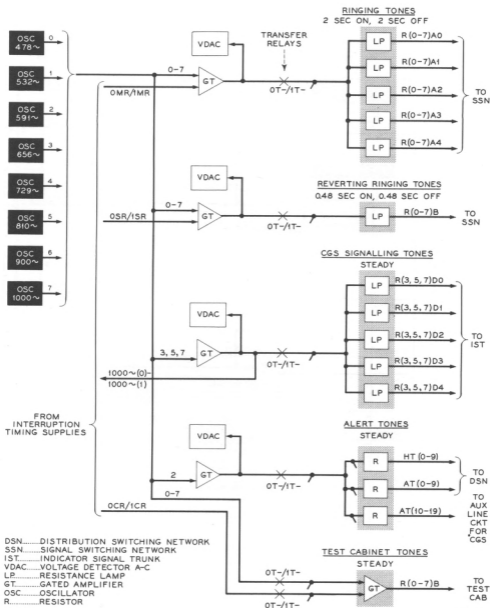

FIG. 13-3. Ringing tone supply, block diagram.

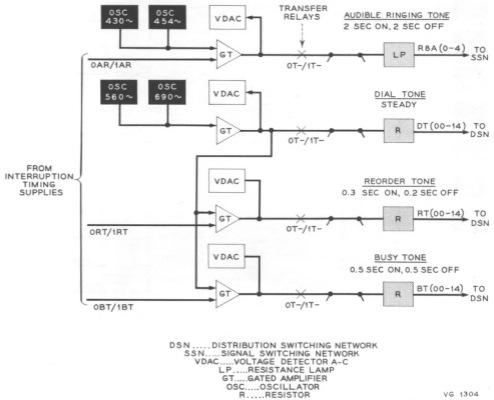

FIG. 13-4. Tone supply, block diagram.

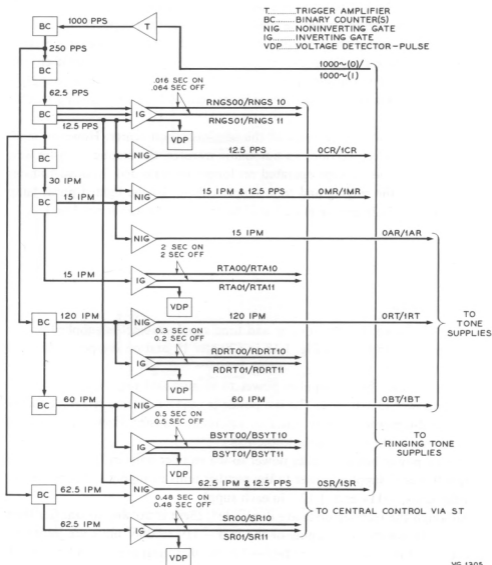

FIG. 13-5. Interruption timing supply, block diagram.

13.3 DUPLICATION AND TRANSFER

Duplicate interruption timing supplies, tone supplies, and ringing tone supplies assure the ESS of tones in case the preferred supply 0 should fail completely. The tone amplifiers for the local test cabinet are not duplicated, however.

Automatic transfer from supply 0 to supply 1 occurs whenever supply 0 develops a trouble condition that is more serious than the trouble (if any) in supply 1. Automatic transfer from supply 1 to supply 0 occurs when supply 1 develops a trouble that is equal to or more serious than any existing trouble in supply 0.

Manual transfer may be made at the administration center. However, since the manual transfer overrides an automatic transfer, the manual transfer key, RTS0/RTS1, should be kept operated no longer than needed. Manual transfer is indicated at the ringing and tone supply cabinet by the lighted green lamp MAN. The supply in service is indicated by the lighted green lamp 0 or 1.

13.4 POWER

The power for the ringing and tone supply cabinet is supplied on a-c power buses B and C (see Fig. 1-18 in Chapter 1), and on d-c power buses B and C (see Fig. 1-19).

The d-c power bus B supplies power to ringing and tone supply 0; bus C supplies power to supply 1. The d-c power is used to operate relays. A failure on either d-c power bus may cause an automatic transfer. However, there will be no break in the tone supply to the ESS.

The a-c power bus B supplies power to the rectifier units in ringing and tone supply 0; bus C supplies power to the rectifier units in supply 1. There are two rectifier units, -11v and $+12\text{v}$, in each supply.

Although the rectifier units are duplicated, there is no way to transfer their outputs. Therefore, the outputs of the two -11v rectifier units are joined by fuse C1, and the outputs of the two $+12\text{v}$ rectifier units are joined by fuse C2. By paralleling the outputs, the in-service ringing and tone supply is assured of power regardless of which rectifier unit, in a pair, may fail. This arrangement also assures power when either a-c power bus fails.

13 . 5 MAINTENANCE

Maintenance on the in-service ringing and tone supply is not necessary, because of duplication of the equipment, Lamps on the front bay will help you in locating any trouble that occurs. The details of trouble analysis and troubleshooting are covered in Specification X-63952. The voltage of the outputs of the rectifier units is checked periodically by the voltage monitor in the administration center.

Chapter 14

Power Distribution

The electrical power to operate ESS equipment is distributed to the various cabinets via the power distribution cabinet. This cabinet is located with the switching equipment. It is the power control and distribution center for the ESS.

14.1 EQUIPMENT ARRANGEMENTS

The power distribution cabinet consists of one bay of equipment, designated PD-0; a front view of the cabinet is shown in Fig. 14-1, and a rear view in Fig. 14-2.

The upper half of the bay contains equipment for distributing the a-c power via the A, B, and C buses. A-C meters are provided for measuring frequency, power, current, and voltage on each of the three buses. Below the meters are three rows of circuit breakers and their associated toggle switches, one row for each bus. Three neon power-on lamps indicate, when lighted, that power is on each bus. The red alarm lamp lights when a circuit breaker operates to indicate an overloaded circuit. The green guard lamp, when lighted, indicates that a circuit breaker alarm circuit toggle switch is operated. The toggle switch is used for two purposes: (a), to retire the alarm brought in when the circuit breaker operates electrically; and (b) to prevent bringing in an alarm when the circuit breaker is manually operated to OFF.

The lower half of the bay contains equipment for distributing the d-c power via another set of A, B, and C buses. D-C meters are provided for measuring current and voltage on each of the three buses. Below the meters are three rows of fuses, one row for each bus. Three white power-on lamps indicate, when lighted, that power is on each bus. The red alarm lamp lights when a fuse blows to indicate an overloaded circuit. The green guard lamp, when lighted, indicates that a fuse has blown and the guard feature has not been reset. When the blown fuse has been removed, the alarm lamp is extinguished; however, the guard lamp remains lighted until the reset button is operated.

14.2 METHOD OF OPERATION

14.2.1 A-C Power Distribution—Figs. 14-1, 14-3

Alternating current of 230 volts is supplied over the A, B, and C bus leads from the ESS power plant. Each bus lead is connected to a horizontal bus bar on the power distribution cabinet. Each "hot" bus bar has an associated ground bus bar. Each pair of bus bars serves up to twenty circuit breakers (CB-). Each circuit breaker has an associated toggle switch (S-). Three neon lamps, BUS A, BUS B, and BUS C, are lighted when a-c power is being supplied to the bus bars.

When an a-c circuit is overloaded, the circuit breaker operates to cut off the overloaded a-c circuit and to close a shunting circuit (through the associated toggle switch) around the winding of the normally operated K1 relay. This releases relay K1, which closes a circuit to light the 230 VOLTS AC ALARM lamp. Now operate the toggle switch to light the 230 VOLTS AC GUARD lamp, and to extinguish the AC ALARM lamp. After the overload has been removed, you can return the circuit to service by operating the circuit breaker manually to ON.

When you have verified the absence of the overload, restore the toggle switch to extinguish the AC GUARD lamp.

14.2.2 D-C Power Distribution—Figs. 14-1, 14-3

The -48 volts d-c power is supplied over the A, B, and C bus leads from the No. 5 crossbar office battery supply. Each bus lead is connected to a horizontal bus bar on the power distribution cabinet. Each bus bar serves up to 22 fuses. Three lamps, BUS A, BUS B, and BUS C, are lighted when d-c power is being supplied to the bus bars.

When a d-c circuit is overloaded, the fuse blows and closes the circuit to light the 48 VOLTS DC ALARM lamp. It also operates the K2 relay, which locks and lights the 48 VOLTS DC GUARD lamp.

When you remove the blown fuse, the DC GUARD lamp remains lighted, but the DC ALARM lamp is extinguished. After the circuit overload has been removed, you can return the circuit to service by installing a new fuse.

When you have verified the absence of the overload, momentarily operate the 48 VOLTS DC GUARD RESET key to release the K2 relay and extinguish the DC GUARD lamp.

The three figures for Chapter 14 are shown on pages 332, 333, and 334.

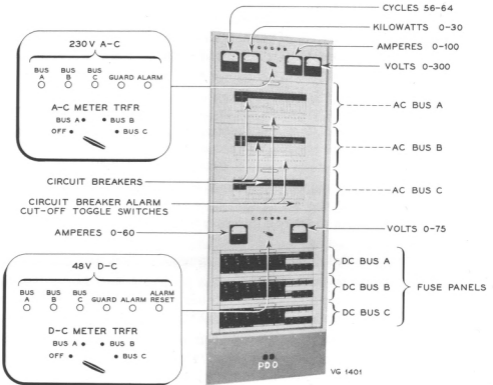

FIG. 14-1. Power distribution cabinet, front view.

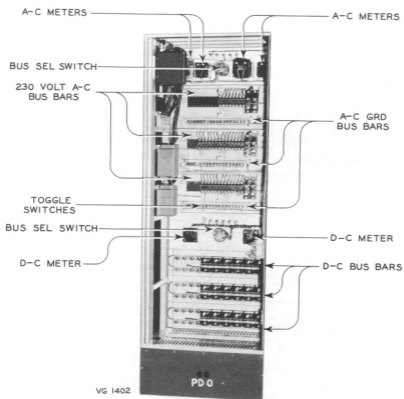

FIG. 14-2. Power distribution cabinet, rear view.

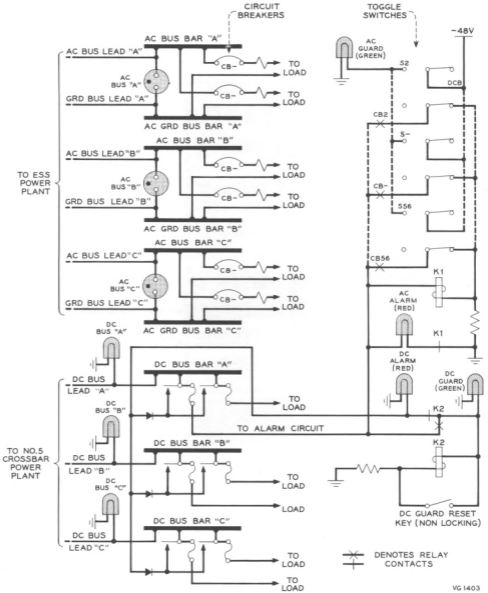

FIG. 14-3. A-C and D-C power distribution.

Chapter 15

The Alarm System

The ESS has an alarm system that indicates trouble conditions when they occur within the cabinets and in the power plant. Some of the alarms are brought in directly from the equipment in trouble; others are brought in when troubles are detected during the system fault-checking routine. All of these alarms give a visible and audible signal; and in most cases the teletypewriter prints a trouble record.

The alarm lamps are located at the cabinets, at the end of the line-up of cabinets, and at the administration center. The audible signals are located at strategic points in the office.

The alarm system includes two fire-wire loops. A failure in either of these loops causes an emergency alarm to be sounded. One fire-wire loop is installed in the network cabinets; a failure in this loop will turn off the network cabinet air-conditioning blower fan and sound the emergency alarm. The second fire-wire loop is installed in the other ESS cabinets; a failure in this loop will turn off the room air-conditioning blower fans and sound the emergency alarm.

The alarm keys, lamps, and associated equipment are located at the administration center. The lamps indicate which equipment is in trouble and which equipment is in service. The keys are used to release and group the alarms. Some of the keys are used to control the cabinet air-conditioning equipment.

A major audible alarm indicates troubles that require immediate attention. It is given by a loud-sounding single-stroke tone bar. A minor audible alarm indicates troubles of lesser importance. It is given by a loud-sounding bell. Power plant failures are indicated by a loud-sounding gong. The emergency alarm is a loud-sounding horn.

The ESS maintenance center is located at the administration center. However, by operating the alarm grouping key (AG), the ESS alarms can be switched to

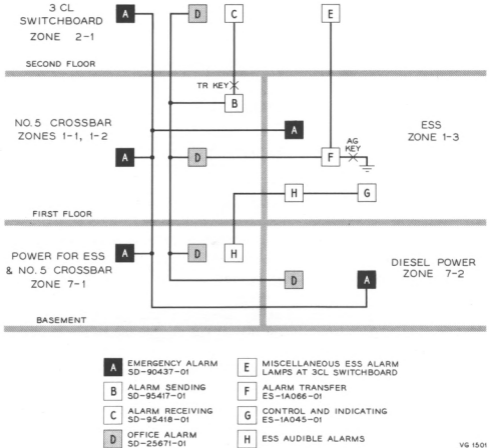
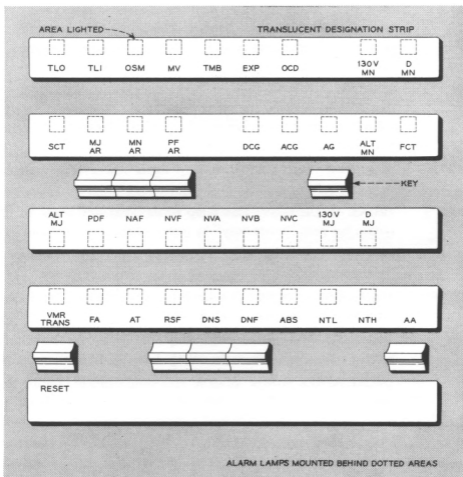

FIG. 15-1. Floor layout of alarm systems and alarm zones.

VG 1501

the No. 5 crossbar maintenance center, which is located at the master test frame. The operation of the AG key also permits the ESS alarm lamps to be lighted at both the administration center and the 3CL switchboard.

Coded audible signals are used to identify the zone in which an emergency alarm exists in the ESS and the No. 5 crossbar system. Exit pilot lamps are located on each floor. The floor layout of both alarm systems and the alarm zones are shown in Fig. 15-1.



VG 1502

FIG. 15-2. Trouble-indicating lamps and control keys at the administration center.

The ESS trouble-indicating lamps and the control keys are located at the administration center; they are arranged in a panel, as shown in Fig. 15-2. The function of each lamp and key is given in the list on pages 338 through 341, which follows the order shown on the designation strips.

Top Lamp Strip

TL0 }	TEST LAMPS. These lamps light to indicate the state of a particular spot in the barrier grid tube: i. e., to show whether the spot is a "zero" or a "one."
TL1 }	
OSM (*)	ONE-SPOT MONITOR. This lamp lights whenever a particular signal that is being read by the system is a "one." This signal may be a flip-flop output, a scanner point, or a particular spot in a barrier grid tube.
MV (*)	MARGINAL VOLTAGE. This lamp lights whenever a marginal voltage test is being made in the system.
TMB (*)	TRUNK MADE BUSY. This lamp lights when any trunk in the system has been "made busy" by means of the teletypewriter.
EXP (*)	EXPOSURE CONTROL. This lamp lights to indicate the operation of the shutters in the FSS when the plates are being prepared.
OCD	OPEN CABINET DOOR. This lamp lights when any cabinet door in the system is opened.
130V MN	130-VOLT MINOR ALARM. This lamp lights when the 130-volt d-c battery voltage varies from the voltage limits of the floating charge.
D MN	DIESEL POWER MINOR ALARM. This lamp lights to indicate that power is being supplied by the emergency diesel power plant.

Second Lamp Strip, and the Keys below the Lamps

SCT	SECOND TROUBLE. This lamp lights when a second trouble exists in the system. This occurs when a stand-by unit is in trouble at the same time that its in-service duplicate unit is in trouble.
MJ	MAJOR ALARM. This lamp lights when a trouble in the system requires immediate attention.
MJ (key) AR	MAJOR ALARM RELEASE. This nonlocking key, when operated, silences the major tone bar, but does not extinguish the lamp. After a fixed interval, the ESS program causes the lamp to be

*These lamps are monitors; no audible alarm is given when any of these lamps is lighted.

extinguished, provided no other major alarm condition occurs during the interim period.

- MN** MINOR ALARM. This lamp lights to indicate the presence of a trouble not of major importance.
- MN** (key) MINOR ALARM RELEASE. This nonlocking key, when operated,
AR silences the minor alarm bell.
- PF** POWER FAILURE. This lamp lights when any of the major power alarms indicates a failure.
- PF** (key) POWER FAILURE ALARM RELEASE. This nonlocking key, when
AR operated, silences the PF alarm gong.
- DCG** DIRECT-CURRENT GUARD. This lamp lights when a fuse blows in the power distribution cabinet. A D-C Guard Reset key (nonlocking) in the power distribution cabinet must be operated after replacing the fuse. This will re-activate the alarm system and extinguish the DCG lamp.
- ACG** ALTERNATING-CURRENT GUARD. This lamp lights when a circuit breaker opens. Whenever a circuit breaker is open, the switch below the circuit breaker must be operated manually to the opposite position. This action allows the remaining circuit breakers to function with the alarm system.
- AG** (key) ALARM GROUPING. This locking key, when operated, causes the ESS alarm system to be switched to the No. 5 crossbar alarm system, and the ESS alarm lamps appearing at the administration center to be switched to the 3CL switchboard.
- ALT** ALTERNATOR MINOR ALARM. This lamp lights (1), when a
MN high-output or a low-output voltage condition exists; or (2), when there is a transfer of the motor drive from a regular unit to a stand-by unit.
- FCT** FAN OR COMPRESSOR TRANSFER. This lamp lights (1), when the motor of either the network or the room air-conditioning fan is transferred to the stand-by unit; or (2), when the regular or stand-by compressor fails.

Third Lamp Strip

ALT MJ	ALTERNATOR MAJOR ALARM. This lamp lights (1), when any alternator fuse blows; (2), when an alternator fails; or (3), when an a-c drive motor fails.
PDF	POWER DISTRIBUTION FAILURE. This lamp lights when a circuit breaker opens, or when a fuse blows in the power distribution cabinet.
NAF	NO AIR FLOW. This lamp lights when no air flows in the switching network or room air-conditioning ducts.
NVF	NO VOLTAGE FAILURE. This lamp lights when one or more of the fuses supplying the "no voltage" relays (NVA, NVB, or NVC) has blown.
NVA	NO VOLTAGE A BUS. This lamp lights when there is no voltage on the—48v A bus.
NVB	NO VOLTAGE B BUS. This lamp lights when there is no voltage on the—48v B bus.
NVC	NO VOLTAGE C BUS. This lamp lights when there is no voltage on the—48v C bus.
130V MJ	130-VOLT MAJOR ALARM. This lamp lights when the 130-volt d-c battery voltage varies from the high or low voltage limits.
D MJ	DIESEL POWER MAJOR ALARM. This lamp lights when the diesel power plant is called to start.

Fourth Lamp Strip, and the Keys below the Lamps

VMR	VOLTAGE MONITOR REFERENCE. This lamp lights to indicate that the normally in-service reference voltage supply unit has failed, and that the stand-by unit has been switched into service.
VMR TRANS (key)	VOLTAGE MONITOR REFERENCE TRANSFER. This nonlocking key is used to transfer the operation from the normally in-service reference voltage supply unit to the stand-by unit.
RESET (key)	RESET. (See VMR lamp and VMR TRANS key above.) This nonlocking key is used to reset or transfer the operation from the

stand-by reference voltage supply unit back to the unit that is normally in service.

- FA** FUSE ALARM. This lamp lights when a fuse blows, when a circuit breaker opens, or when the power is turned off in a major unit power cabinet.
- AT** AIR TEMPERATURE. This lamp lights when the air temperature in a particular cabinet rises above 105° F.
- RSF** ROOM SUPPLY FAN. This guard lamp lights when the RSF key (see below) is operated to control the air-conditioning fans.
- RSF (key)** (See RSF lamp above.) This locking key is used to control the air-conditioning fans if the fire-detection wire opens from a cause other than a fire.
- DNS** DISTRIBUTION NETWORK SHUTOFF. This guard lamp lights when the DNS key (see below) is operated to shut down the fan when testing is required in the switching network cabinets.
- DNS (key)** (See DNS lamp above.) This locking key is used to shut off the fan in the switching network cabinets.
- DNF** DISTRIBUTION NETWORK FAN. This guard lamp lights when the DNF key (see below) is operated to control the air-conditioning fans.
- DNF (key)** (See DNF lamp above.) This locking key is used to control the air-conditioning fans if the fire-detection wire opens from a cause other than a fire.
- ABS** ALARM BATTERY SUPPLY. This lamp lights when an alarm battery fuse blows.
- NTL** NETWORK TEMPERATURE LOW. This lamp lights when the temperature in the network cabinets is less than 74° F.
- NTH** NETWORK TEMPERATURE HIGH. This lamp lights when the temperature in the network cabinets is above 74° F.
- AA (key)** ADVANCE ACTIVATOR. This non-locking key is used to start certain programs within the system after instructions have been inserted by means of the teletypewriter.

Chapter 16

Customer Group Service and Bridged Extension Service

Customer Group Service, or CGS, is the term used in the electronic switching system for PBX, wiring plan, and key telephone services.

With CGS, the customer lines terminate directly in the ESS in the Morris central office. Calls to and from these lines are switched automatically in the ESS. This differs from other systems in which the calls for service of this type are switched on the customer premises, either automatically or by an attendant there. All incoming calls to ESS customers having CGS can be completed automatically by direct inward dialing.

Customer group service is furnished by the ESS on either an attended or an unattended basis, as described in Sections 16.1 and 16.2 below.

Bridged Extension Service in the ESS includes a new feature not available in any of the present dial telephone systems. It permits a customer having extension telephones to dial a call to another extension on his line. This feature, which is available to individual and party-line customers for business or residence service, is described in Section 16.3.

16.1 UNATTENDED CGS

Members of an unattended CGS group may call each other by dialing a two-digit or three-digit code, or a seven-digit directory number, as described in subsection 16.1.1. Unattended CGS also provides facilities for "add-on," "hold," and "pick-up" features.

16.1.1 *Method of Operation*

Calls to customers or operators outside the CGS group can be made in the usual manner from any station in the group by dialing a seven-digit

directory number, a three-digit service code, or the "zero" operator code. Additional telephone functions that are available in an unattended CGS installation are outlined in the following paragraphs.

CGS Line Connections

The lines served by CGS have "class of service" indications to identify them in the ESS. Special translation features indicate which line is associated with each station number. The lines within a CGS group may call each other in either of two ways: (1), by dialing the digit "1" followed by the CGS station number; or (2), by dialing the seven-digit directory number associated with the called station.

"Add-On"

Another station can be added to an established connection by dialing the digit "1" followed by the number of the station to be added. The "add-on" station may be within the CGS group, or it may even be an external station obtained by dialing a seven-digit directory number, a three-digit service code, or the "zero" operator code. The indications received on a call of this kind are listed in Table 16-1, on page 344.

"Hold"

An established CGS connection can be held by dialing the digit "2." The held connection can be recalled later by dialing the digit "1" followed by the CGS station number from which the holding "2" had previously been dialed (your own number).

"Pick-Up"

A call coming in to any station in a CGS group can be picked up by another station within the group by dialing the digit "3" followed by the digit "1" and the number of the station that is being rung.

16.2 ATTENDED CGS

In attended CGS installations, an attendant's set is provided on the customer premises to handle calls that are not completed automatically by direct inward dialing. Also, certain outgoing calls will require the service of an attendant. There are two systems for signaling the attendant's telephone set: an audible system and a visible system. The signals to the attendant for each

TABLE 16-1. INDICATIONS RECEIVED ON "ADD-ON" CALLS

Condition Encountered	THE STATION TO BE ADDED IS		
	Within the ESS office	"Zero" Operator	Outside of the ESS office
Called station is busy	2 busy tones	—	A 591-cycle tone for $\frac{1}{4}$ to $\frac{1}{2}$ second
All circuits or paths are busy	4 reorder tones	4 reorder tones	A 591-cycle tone for $\frac{1}{4}$ to $\frac{1}{2}$ second
Called station does not answer	A 591-cycle tone for $\frac{1}{4}$ to $\frac{1}{2}$ second	—	A 591-cycle tone for $\frac{1}{4}$ to $\frac{1}{2}$ second

TABLE 16-2. VISIBLE AND AUDIBLE SIGNALS TO THE CGS ATTENDANT

Illuminated Designation	Spoken Announcement	Meaning
ALERT	(A steady tone)	Action required on a waiting call.
INC	"Incoming"	A new call from outside the CGS.
BUSY	"Busy"	The called CGS station is busy.
READY	"Ready"	A CGS station formerly busy becomes idle, and is now being held for connection to a waiting call.
DA	"No Answer"	An idle CGS station has not answered after 45 seconds of ringing.
STA	"Station"	A new call from a station within the CGS; a call from a tie line associated with the CGS; or a recall from an established connection.
REORD	"Try Again"	The CGS attendant should redial a call just dialed, since a condition of "trunk busy" or "paths busy" was encountered on the previous dialing.

Note: The codes dialed by the CGS attendant for service connections are shown in Table 16-3.

system are listed in Table 16-2. The codes to be dialed by the CGS attendant are described in Table 16-3, on page 346.

16.2.1 Equipment Arrangements

When the CGS attendant's set is to be signaled on the visible basis, an auxiliary line circuit is required for each CGS attendant's telephone set [see Fig. 16-2 and (a) of Fig. 16-1]. The auxiliary line is connected in series with the conductor loop to the attendant's telephone set. In addition, a lamp control circuit, shown in Fig. 16-4 on page 350, is required in the attendant's telephone set to give lamp indications. A second pair of conductors is needed for this function.

When the CGS attendant's set is to be signaled on the audible or "announcement" basis [see (b) of Fig. 16-1], duplicate announcement systems are provided (one regular and one stand-by), as shown in Fig. 16-3. The repertory of announcements consists of: "Incoming," "Busy," "Ready," "No Answer," "Station," and "Try Again." These announcements are connected to the line through the announcement trunk on the distribution switching network in the ESS.

Each announcement cabinet contains a motor-driven magnetic drum with eight tracks as shown on Fig. 16-3. Facilities are provided for recording and monitoring on the magnetic drums.

Both machines operate continuously. If the first machine fails, the second machine is connected automatically without interruption of service.

16.2.2 Method of Operation

Calls to customers or operators outside the CGS group can be made in the usual manner without the assistance of the CGS attendant by dialing a seven-digit directory number, a three-digit service code, or a "zero" operator code. If assistance is required, the CGS attendant may be signaled by dialing the digits "10".

Calls from one CGS station to another station within the same group may be made by dialing the digit "1" followed by the one-digit, two-digit, or three-digit station number of the called station. (Such a dialing sequence is known as

TABLE 16-3. CODES DIALED BY THE CGS ATTENDANT

Code	Connection Requested
"0"	(a) Connect to the "zero" operator. (b) Flash the toll operator.
"1"	To answer an "alert" signal.
"2"	Hold the present connection.
"3"	Pickup; to be followed by "1" X* of the CGS station being picked up.
"4"	(a) Check a busy CGS station every 10 seconds for "busy;" if "busy" for 30 seconds, alert the attendant. (b) Continue ringing for another 45 seconds on "no answers." (c) Connect the attendant, the "zero" operator, and a station to a conference trunk ("0" call). (d) Connect a call to a previously busy CGS station. (e) Connect a call to a CGS station (station off-hook).
"10"	Return to a "hold" connection. Relight the lamp or repeat the announcement just sent.
"11"	Disconnect on a call.
"1" X*	(a) Connect to or transfer a call to a CGS station. (b) On "0" operator calls, permits a double connection in order that a call may be announced. (Requires that the CGS attendant dial "11" to be disconnected.)
X* "11"	Connect to a service code, X* "11."
ABX-XXXX*	Connect to, or transfer, a call to a directory number.
"5583"	Close the attended CGS, and set up the night connections (followed by a dialed list of night numbers).
"5584"	To open an attended CGS and to release the night connections.
"5585"	To close an attended CGS and to set up the night connections from a prearranged list.
"559"	Tie-line preference code.
"5999"	To close an attended CGS because of a lamp signal failure, or other failure.
"598"	To open an attended CGS which was closed because of a lamp signal failure or other failure, which has now been cleared.

*The letter "X" represents an unstated number.

a "1X" call, where the "X" represents any number of one, two, or three digits.) Where an associated group station service is provided within a large attended CGS, an intragroup call may be made by dialing a "1X" number, where "X" represents a one-digit private number within the group.

On calls within an attended CGS, an audible ringing signal is received by the calling station, and tone ringing is sent to the called station.

If the called CGS station is busy, the calling station receives a busy tone, which is a combination of two audible frequencies interrupted at a rate of 60 ipm. If the call can not be completed because all circuits or paths are busy, the calling station receives a reorder tone, which is a combination of two audible frequencies interrupted at a rate of 120 ipm. If the called station does not answer, ringing is continued until the calling station hangs up or until a period of five minutes has elapsed, whichever occurs first. If it is desired to ring the

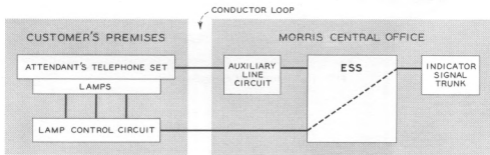

(a) VISIBLE SYSTEM

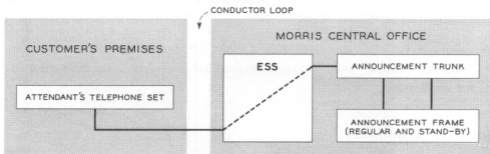

(b) AUDIBLE SYSTEM

VG 1601

FIG. 16-1. Attended CGS, block diagram.



FIG. 16-2. Attendant's telephone set.

called station further, it will then be necessary to originate a new call; that is, to repeat the dialing.

If a customer fails to hang up at the end of a call, this failure results in his line being held busy and out of service.

“Add-On,” “Hold,” and “Pick-Up”

“Add-on,” “hold,” and “pick-up” services are provided in the same manner as for unattended CGS.

16 . 2 . 3 Maintenance

The maintenance of CGS service is similar to the maintenance of other equipment using ESS package units. The package units in trouble are replaced, and the defective package units are repaired at some central point.

The announcement trunks and the magnetic drum amplifiers associated with them are similarly maintained by replacing defective units with good units. The magnetic drums are tested and recorded as covered in maintenance instructions KS-16592, Recorder-Reproducers, and ES-1A053-01, sheet B3, Announcement System.

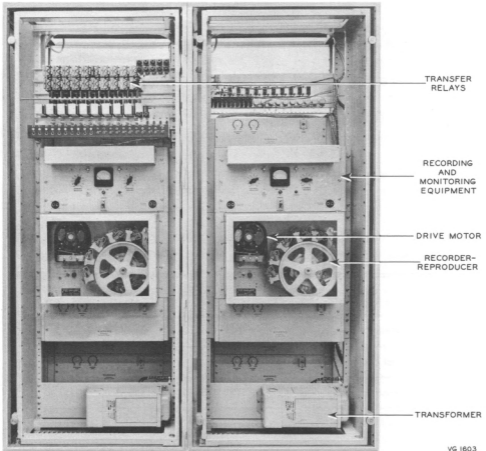
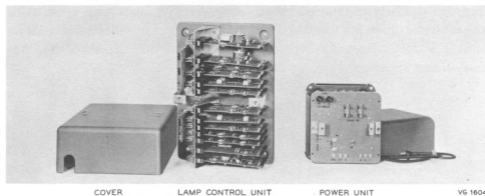

FIG. 16-3. *Announcement system.*



VG 1604

FIG. 16-4. Lamp control unit and power unit.

TABLE 16-4. RINGING CODES FOR BRIDGED EXTENSION SERVICE

Station or extension to be called	Code to be dialed	Rings sounded by the tone ringer
Main Station	"11"	1
First Extension	"12"	2
Second Extension	"13"	3
Third Extension	"14"	4

Note: Up to eight rings can be provided.

16.3 BRIDGED EXTENSION SERVICE

In the ESS, any telephone extension can be dialed from any other extension on the same line. The way in which this can be done is explained as follows.

Suppose that you (the customer) have one main telephone with three extension telephones. To ring another extension on your line, remove the handset from the cradle of any of your telephones and dial the digit "1" followed by "1," "2," "3," or "4," for the extension you are calling. (If you are on a party line, you will need to dial an additional digit, your party code.)

After you have completed your dialing, hang up your phone to allow the tone ringer on the dialed extension to ring. Your own tone ringer and the tone ringers of all the other extensions on your line will ring also. The ringing will be coded according to the number you have dialed. If you have dialed "13," for example, three rings will be sounded. Table 16-4 shows the rings available from one main telephone with three extension telephones. Up to eight rings can be provided in bridged extension service.

When the ringing stops, it indicates that the other (called) extension has been answered. You can now pick up your own handset and proceed with your conversation.

If the other extension does not answer within a reasonable time, remove your handset from the cradle for a few seconds to clear the line and stop the ringing. Then replace the handset on its cradle.

Appendix

Glossary of ESS Technical Terms

The introduction of electronic switching has created a need for appropriate terms to signify its new concepts, circuits, and other innovations. This glossary defines the new words and designations used in this book, as well as a number of technical expressions previously established but not yet in general use. Many of these definitions have been approved and adopted by the Nomenclature Committee of the AT&T Company and Bell Telephone Laboratories.

active: (1) The state of a major unit when it is handling customer traffic or switching functions. (2) The condition of a circuit or device when it is producing an enabling output.

address: Information (usually a number) that designates a location in a storage device or equipment unit.

administration center: The part of the ESS that includes the manual means for controlling the system. It also includes certain automatic test equipment, as well as a recorder for maintenance and traffic information.

analog: A signal or quantity in one language or medium that corresponds to a signal or quantity in another language or medium.

AND-gate: A switching circuit whose output is a "1" if *all* of its inputs are in the "1" state (*see* "bit"). If any of its inputs is a "0," its output is a "0."

announcement system: Used with customer group service (CGS); it informs the CGS attendant, via voice announcements, of the status of a call.

automatic plate processor: A machine used to develop and process the photographic information plates used in the flying spot store.

barrier grid store: A store in which the memory medium is a barrier grid tube.

binary number system: A number system that uses two symbols (usually denoted by 0 and 1), with two as its base; just as the decimal number system uses ten symbols (0 through 9) with ten as its base.

bistable: Having two distinct states of stability.

bit: The binary unit of information. It is represented by one of two possible conditions, such as: the digit 0 or 1; an electrical charge or no electrical charge; or transparent or opaque spots on a photographic plate.

buffer circuit: An isolating circuit used between two other circuits. The signal distributor is a form of buffer. It accepts high-speed signals from the central control and transmits them to devices of slower speed in trunk circuits.

- central control: The part of the ESS that controls the operation of the other parts through the interpretation of data in accordance with predetermined instructions.
- CGS: See "customer group service."
- circuit package: A small replaceable unit, usually in the form of a printed-wiring board, containing mounted components constituting one or more circuits.
- clamping: The function of holding some point of a circuit to a particular voltage.
- coaxial cable: A transmission line consisting of two conductors concentric with, and insulated from, each other.
- computer: A machine capable of performing logical operations on data stored within or presented to it.
- concentration marker: The part of the ESS that uses marking techniques to control the operation of the concentration switching network.
- concentration switching network: The switching network used to interconnect unequal numbers of communication channels.
- customer group service (CGS): The term used to indicate PBX service, wiring plan, or key telephone customer service.
- diagnostic test program: A test program used to locate faulty circuit operations within a unit.
- digit, least significant: The digit that, when changed, least affects the magnitude of a number. For example, the units (*last*) digit in a decimal number is the least significant, as in 9345.
- digit, most significant: The digit that, when changed, most affects the magnitude of a number. For example, in any decimal number the *first* number is the most significant, as in 5892.
- diode: A two-electrode device that is a good conductor for one polarity and a poor conductor for the opposite polarity.
- directed scan: (*Also see* "supervisory scan.") A one-at-a-time operation, not occurring in normal sequential scanning, in response to a specific order.
- distribution marker: The part of the ESS that uses marking techniques to control the operation of the distribution switching network.
- distribution switching network: The switching network used to interconnect approximately equal-sized groups of communication channels.
- double-rail: See "twin-rail."
- electrostatic storage tube: A cathode-ray tube having a mica-plate target on which electrostatic charges (minute deposits of electrons) are stored or removed.
- enable pulse: A pulse that permits a unit or circuit to become operative.
- error correction: A method of detecting and correcting single-bit errors in program and translation information.
- extended area service: Customer calling distance extended beyond the local area.
- firing of a tube: (*See* "gas diode.") The breakdown of the gap in a gas-discharge tube.
- flip-flop: A device capable of assuming two stable states (set or reset) and storing a bit of information. It remains in either state until a signal changes it to the other state.

- flying spot store:** A store in which a cathode-ray tube is used to gain access to a photographic memory medium.
- gas diode:** A two-element unit in which the gas breaks down (the tube fires) when a required voltage is applied across the electrodes. The gas discharge creates an electrical path to transmit the speech current or to control a connection.
- interlock:** An electromechanical safety arrangement that shuts off the high-voltage supply when certain gates and doors of cabinets are opened.
- junction:** The connecting link between the A and B sides of the distribution switching network.
- logic:** The science of the formal principles of reasoning.
- magnetic core:** A toroidal device capable of storing information by means of its two directions of polarization.
- memory element:** Apparatus having the faculty of retaining one bit of information. A relay, a flip-flop, or a spot on a barrier grid tube or photographic plate may act as a memory element.
- module:** (As used in the switching network.) A plug-in type of package containing components connected together to form a switch or other circuit.
- network:** A system of interconnected elements consisting of such devices as inductors, resistors, capacitors, gas diodes, etc.
- off-hook:** The condition that indicates the active state (loop closed) of a customer line.
- on-hook:** The condition that indicates the idle state (loop open) of a customer line.
- order:** A command or instruction given by one unit of equipment to another specifying certain functions to be performed. Such specific functions may be: *transfer, operate, expose, read, write, etc.*
- OR-gate:** A switching circuit whose output is a "1" if *any* of its inputs is a "1" (see "bit"); otherwise, a "zero." (Also see "AND-gate.")
- paralleling unit:** A unit used to isolate the outputs of two rectifiers operating in parallel into a common load; such a unit contains alarm circuits to indicate the failure of a rectifier.
- parity check:** A check on the validity of a "word." One method is to check the number of "1's" in a word; for example, whether the number of "1's" is odd or even.
- photoelectric multiplier tube:** A phototube in which the initial photoemission current is multiplied many times before being extracted at the anode.
- program:** An organized set of instructions.
- raster:** A predetermined pattern of scanning lines or spots that provide a uniform covering of a specified area.
- read:** To extract the information stored in a memory device.
- regenerate:** To replace a charge to overcome decay effects, including any loss of charge caused by the reading itself.
- register:** A functionally associated set of memory elements with or without its controls and access; a word repository. See Chapters 8 and 10 for types of registers.

- remote line concentrator:** An outside plant unit, remotely situated, which accommodates many customer lines and concentrates them into comparatively few trunks to the central office.
- reset:** (*Also see "set."*) (1) To restore a storage device to a prescribed state. (2) A flip-flop reset in one of its two stable states, namely, the "reset" or "zero" state.
- scanner:** The part of the ESS that provides the central control with information access to lines, trunks, and test points.
- semiconductors:** Materials which lie between metals and insulators in their ability to conduct electricity.
- sequential:** A manner of action, or operation, of equipment in which instructions, or orders, are set up in a sequence (following a specific space or time pattern), and are fed consecutively to equipment during the progress of a switching function.
- serial:** A type of action, or operation, whereby a number or signal is handled in an orderly arrangement of one item following another.
- set:** (*Also see "reset."*) (1) To place a storage device in a prescribed state. (2) A flip-flop set in one of its two stable states, namely, the "set" or "one" state.
- shutter:** A mechanical device used to stop the transmission of light from the photographic lens inside the flying spot store.
- signal distributor:** The part of the ESS that provides access from the central control to one of a large number of outputs.
- signal switching network:** A switching network interconnecting tone sources and trunks to supply the tones and ringing frequencies.
- significant:** *See "digit."*
- single-rail:** (*Also see "twin-rail."*) A method of representing the state of a bit, in which a "1" is represented by a voltage on a single lead and a "0" is represented by the absence of a voltage on that lead.
- skew ringing connection:** A connection set up when both the calling customer trunk and the called customer trunk are on the same side (as contrasted with the normal opposite sides) of the distribution switching network.
- stages:** As used with the distribution switching network, they are stages 1 through 6 of an electrical transmission path.
- stand-by:** The state of a unit when it is not handling customer switching functions, but ready and able to do so. Units in the stand-by state may perform checking operations or be matched against the active units.
- stand-by transfer:** The part of the ESS that switches duplicated major units between the active state and the stand-by state.
- store:** A unit or device in which information is kept until the system is ready to use it.
- supervisory:** (*Also see "supervisory scan."*) An action or operation that performs a service of inspecting or directing other actions or operations.
- supervisory scan:** (*Also see "directed scan."*) A one-at-a-time operation, occurring in normal sequential scanning, to detect disconnects, requests for service, or routine test results.

switching networks: The concentration switching network, the signal switching network, and the distribution switching network are collectively called the switching networks.

time division: A method of allocating a different time interval for the transmission of various signals over a common medium.

tone ringer: Located in the station telephone set, the tone ringer responds to the different frequencies used with single-party, two-party, and eight-party lines.

tracking regulator: A voltage regulator that maintains a preset voltage difference between its input and output terminals.

transistor: An electronic semiconductor device with three or more electrodes. It is used for rectifying and/or amplifying signals.

trouble: The state of a unit when it is not available for service: that is, when it is in neither an active nor a stand-by condition.

twin-rail: (*Also see* "single-rail.") A method of representing the state of a bit, in which a "1" is represented by a voltage on one wire of a pair and the absence of a voltage on the other wire; these voltage states are reversed to represent a "0." Sometimes called "double-rail."

word: A set of characters associated to express system information. (The term "word" may be prefixed by an adjective describing the nature of the characters, as "binary word.")

write: To insert information into a memory device.

